



---

fertilizer spreader

SV-5



---

**STARTING  
MAINTENANCE  
DOSAGE**

---

please read carefully prior to operation!

---

4ª Edition - 11-2011-

It is forbidden the total and partial reproduction.

We can modify the specifications without prior notice.

---

*Seed Drills and Fertilizer Spreaders SOLÀ are produced in a factory particularly specialized in this kind of machines and they are guaranteed for the experience of the users.*

*The are machines based on state-of-the art technology and are manufactured with recognized safety requirements for doing an excellent work with a minimal maintenance.*

*The purpose of this operating manual is to enable you to familiarise yourself with the working of your seed drill and to achieve your purposes.*



---

# TABLE OF CONTENTS

1. INTRODUCTION .....	4
2. TECHNICAL SPECIFICATIONS .....	5
3. SAFETY INSTRUCTIONS .....	6
3.1 Safety symbols .....	6
3.2 Proper use .....	8
3.3 General specifications .....	8
4. ESSENTIAL CONCEPTS FOR FERTILIZING.....	10
5. FERTILIZER SPREADER SETTINGS .....	11
5.1 Shorten method .....	11
5.2 Physical knowledge of the fertilizer.....	12
5.3 Working width settings.....	13
5.4 Flow setting .....	15
6. BORDER FERTILIZED .....	17
7. FLOW TEST.....	18
8. CARE AND MAINTENANCE.....	19
9. DOSAGE TABLES.....	20
10.SPARE PARTS.....	24
10.1 TRANSMISION UNIT.....	25
10.2 SHAKER.....	26
10.3 REAR PROTECTION.....	27
10.4 TRANSMISSION PROTECTION.....	28
10.5 GRADATION UNIT.....	29
10.6 DRIER.....	30
10.7 COMPLETE MACHINE.....	31
10.8 HYDRAULIC EQUIPMENT OPENING AND CLOSING.....	32
10.9 BRAKE UNIT.....	33
10.10 ELECTRONIC EQUIPMENT.....	34
10.11 DISTRIBUTION EQUIPMENT.....	35

# 1. INTRODUCTION

Before you proceed to operate the fertilizer spreader, please read and observe these instructions. In this way, you will avoid accidents, reduce repair costs and downtimes and increase the reliability and service life of your fertilizer spreader.

This operating manual must be read and used by all persons who are required to work with the fertilizer spreader (including preparatory work, troubleshooting during operation, care), maintenance (inspection and technical servicing) and transporting.

Pay particular attention to the safety instructions. SOLÀ cannot assume any liability for damage or malfunctions caused by a failure to observe the instructions contained in this operating manual.

First of all, the manual will explain the Technical Specifications, the Safety Instructions, and some Essential Concepts for fertilizing. In the chapters Border Fertilized, Flow Test and Maintenance, the manual will explain the basic instructions for working with the machine. This manual is finished with a Dosage Table with different types of fertilizers.



SOLÀ reserves the right to make changes to the illustrations, technical specifications and weights contained in this operating manual if SOLA makes any improvements to the fertilizer spreaders.

## 2. TECHNICAL SPECIFICATIONS FERTILIZER SPREADER SV-5



Type	Litres	Height	Hopper sizes	Wheels
SV-5	4500	2300	2600x2300	500-50-17/14PR

### STANDARD EQUIPMENT

- Distributor group oil-immersed
- Double stainless-steel discs
- Hydraulic brake (service) and mechanical brake (parking)
- Selector sieve of 1,5 m x 1,5 m
- Set of lights (range light, winking light, stoplight)
- Support
- Opening-closing hydraulic control
- Service stair

### OPTIONAL EQUIPMENTS

- Homocinetic power point
- Sieve with access door
- Hydraulic engine Kit
- Cover

### 3. SAFETY INSTRUCTIONS

#### 3.1 SAFETY SYMBOLS

You will find, in this operating manual, three types of safety and danger symbols:



To facilitate operation with the fertilizer spreader.



To avoid damages on the fertilizer spreader or in the equipments.



This symbol warns of the risk of injury.

On the machine, you will find the following symbols:



Please, read all the safety instructions contained in this operation manual with care and also observe all warning signs attached to the fertilizer spreader.



Stay away of the tractor back part during the coupling operation, during the coupling manoeuvre.  
**Danger of serious lesions.**



If you are working under the machine it is very important to assure it to avoid its collapse.

**Danger of serious lesions.**

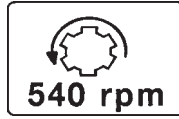

Direction and speed of the power point.



Danger of serious lesions caused by the discs and spreader blades.



Coupling point for the transport by crane.



Stop the tractor engine and avoid its start during the maintenance or repairing works in the fertilizer spreader. Consult the operating manual.



Stay away of the fertilizer spreader. Fertilizer grains impact can cause a serious lesions.



## 3.2 PROPER USE

- Fertilizer spreader **SOLÀ SV-5** has been produced for the agricultural works specially for fertilizer with mineral products.
- SOLÀ cannot be held liable for any consequential damage resulting from incorrect use, metering or distributions.
- All relevant accident prevention regulations, as well as other generally acknowledged safety and road traffic regulations, must be observed.
- SOLÀ fertilizer spreaders are intended for fertilizing. Any uses or modifications other than those will automatically exempt SOLÀ from its/his liability in respect on ensuing damages.

## 3.3 GENERAL SAFETY ARRANGEMENTS

- Before starting the machine, it is very important to read the operation safety and road safety.
- Road traffic regulations must be observed when towing the machine on roads.
- Before to bring into operation the machine, it is very important to know the parts and the elements.
- Be extremely careful when coupling and uncoupling the fertilizer spreader to the tractor.
- The transmission of the power take-off must be fitted with a protective equipment and in good conditions. Avoid the turns of the protector tube with the chain. The side of the clutch will be fitted in the fertilizer spreader.
- The transmission of the power take-off must be fitted when the engine is stopped.
- Before to connect the power take-off, make sure that nobody is standing in dangerous proximity to the fertilizer spreader.
- It is forbidden to stay near of the spreader discs when the machine is starting.
- The fertilizer spreader hopper must be filled when the machine is in the ground, with the engine stopped and the fertilizer trap devices closed.

- Do not place strange elements inside the hopper.
- Always, connect the power take-off with the shaft in order to protect the fertilizer spreader and to avoid serious damages.
- It is forbidden to ride to the fertilizer spreader during the transport or during the work.
- Be extremely careful during maintenance works under the machine. It is very important to use support elements to avoid a possible descent of the machine.
- Before starting, verify the visibility around the machine. It is very important verify that nobody is standing at the working area.
- Before working on hydraulic system, always de-pressurize the circuit and switch off the engine.
- The hydraulic system generates extremely high pressures. All piping, hoses and connections must therefore be checked regularly for leakage and visible external damage. Useful life for these elements is not more than six years. You must change them after this time.
- When the fertilizer spreader is full and we have to transport the machine during a long distance, the fertilizer can compress at the bottom of the hopper. In this case, the fertilizer exit devices, are blocked.  
We will open the exit devices, we will start slowly the power take-off and we will wait the fertilizer falls. After the operation, we can place the adjustable levers in the position concerning the chosen flow and we will start to the normal work.

## 4. ESSENTIAL CONCEPTS FOR FERTILIZING

1. **FERTILIZER GRANULOMETRY:** fertilizer with irregular sizes must be refused in order to avoid an incorrect distribution.
2. **P.T.O. SPEED:**  
The P.T.O. speed determines the speed turn discs. Working width will change if the speed is modified. Speed must be at 540 rpm.
3. **WORKING SPEED:**  
Strong changes in working speed can modify the fertilizer quantity. Speed must be steady.
4. **HOPPER POSITION:**  
Hopper position must be horizontal. Lateral movements, forwards and backwards can modify the fertilizer distribution.
5. **WORKING HEIGHT:** working height must be uniform to 75 cm from the ground. Verify the height on the working ground, never in the moment to coupling the machine. Height could be different.
6. **DO NOT FERTILIZER IF IT IS WINDY:**  
The wind modifies the fertilizer grains trajectory and their distribution.
7. **WEAR OF THE DISCS AND BLADES:** discs and blades are essential elements in the fertilizer spreader distribution. Their wear can influence in the fertilizer distribution. It is necessary to have them in good conditions.
8. **VERIFY THE FERTILIZER FLOW:**  
it is very important to realise a previous test in the store to know the fertilizer we are going to spread on the land. The dosage is very variable and it depends on the fertilizer type, density, humidity, etc.
9. **DISTANCE BETWEEN ADJACENT RUNS:** to conserve the distance between runs it is very important to have a good distribution. To know the same distance, follow the adjustment instructions as you can see in the manual. For having more precision, you can do a test in the land with some boxes placed on the ground, verifying the fertilizer quantity collected in each box.

## **5. SETTING OF THE FERTILIZER SPREADER**

### **5.1 METHOD FOR FERTILIZER SPREADER SETTING**

Basic process to adjust the fertilizer spreader is:

1. To know the fertilizer type, granulometry, density, grains specifications, for comparing it with another fertilizer type places in this manual.
2. To know the distribution dose (kg/ha) we are going to spread, depending of the land, soil and fertilizer type.
3. Verify the dosage tables and choose the correct flow in the ruled column kg/ha according to the working speed. Adjust the flow controls as we can see in the tables.
4. To realise a flow test to verify the correct distribution.
5. To fertilize in a little and knew land in order to verify the correct distribution of the fertilizer.

## 5.2 PHYSICAL KNOWLEDGE OF FERTILIZER

The distribution of the fertilizer spreader changes a lot if the fertilizer conditions are different.

It will be necessary, for each fertilizer type, a different adjustment of the fertilizer spreader.

The physical attributes of the fertilizer are:  
density and granulometry

**DENSITY:** it is the weight per volume unity and generally it is measured in  $\text{kg}/\text{dm}^3$ . It can change depending on the fertilizer humidity. We are going to compare the fertilizer density to use with another fertilizer we can see in the dosage tables.

**GRANULOMETRY:** the granulometry informs us about the sizes of the fertilizer grains. In the dosage tables we can see the granulometry of each fertilizer assembling the grains diameter in four groups:

Ø 4,75	% grains more than 4,75 mm diameter
Ø 3,3	% grains between 3,3 mm and 4,75 mm diameter
Ø 2	% grains between 2 mm and 3,3 mm diameter
Ø <2	% grains < 2 mm diameter

For convention, the fraction containing more than 50% determines the fertilizer classification. To consider if a fertilizer is correct, the 90% of the granulometry sizes have to be, at the most, in three contiguous groups.

We can verify the fertilizer granulometry through the boxes with homologate sieves.

With this information we can compare the fertilizer to spread with another placed in the dosage tables.

## 5.3 SETTING OF THE WORKING WIDTH

Observing dosage tables we can see that for a same type of fertilizer, the blades position on the disc changes depending on the working width and the dose to spread.

Fitted on each disc we have two different blades: one blade called "short" and the other blade called "long".

The short blade position is indicated by one or two letters (X - A - B) and a number (1 - 2 - 3). When the letter X is not indicated, the blade will be fitted in the hole without mark.

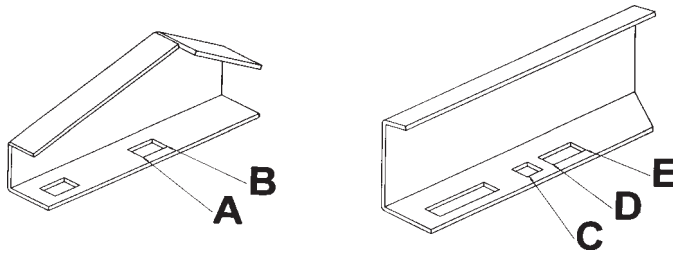

Long blade is indicated by a letter (C - D - E) and a number (4 - 5).

The letters (A - B - C - D - E) inform us about the bolt position concerning the blade, as we can see in the drawing.

The letter X and the numbers (1 - 2 - 3 - 4 - 5) inform us about the blade position on different holes of each disc as we can see in the drawing.

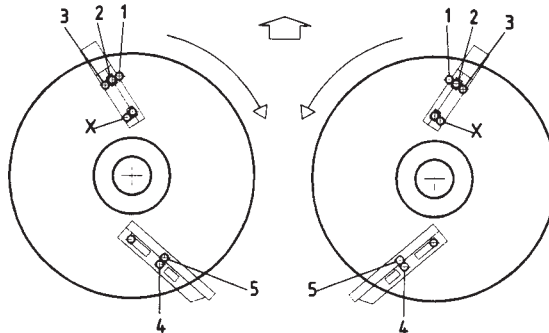



Find as follows an exemple: we want to fertilize with nitrate NAC 26% as we can find on the dosage table (page 21). We need a dose of 150 kg/ha, a working width from 18 m and a working speed of 8 km/h.

We verify in the column of 18 m working width and 8 km/h of working speed the flow case that inform us the nearest value (in this case 158 kg/ha) to the looked forward dose. In the position column of the blades concerning this value we can see the positions XB2 and C4.

The first position refers to the short blade. We have place it in the position B and in the holes X and 2 of the disc. The other position refers to the long blade. We place it in the position C, hole 4 of the disc.

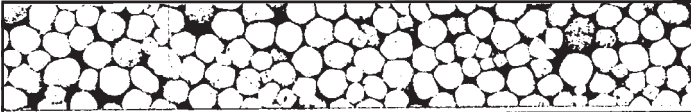
Both discs have always to be placed with the blades in the same positions.



15				18				
Kg/Ha				Kg/Ha				
Km/h			Km/h			Km/h		
10	12		6	8	10	12		
24	20	<b>B2</b>	33	25	20	17	<b>XB2</b>	
56	47		78	58	47	39		<b>C4</b>
88	73		122	92	73	61		
152	127		211	158	127	105		
208	173	<b>B2</b>	289	217	173	144	<b>B2</b>	
288	240		400	300	240	200		
368	306	<b>D4</b>	511	383	306	255	<b>C4</b>	
456	380		633	475	380	316		
544	453		755	566	453	377		
648	539		900	675	539	450		

## 5.4 FLOW SETTING

When we know the fertilizer specifications, we look for the dosage table the fertilizer more similar to the fertilizer we are going to use.

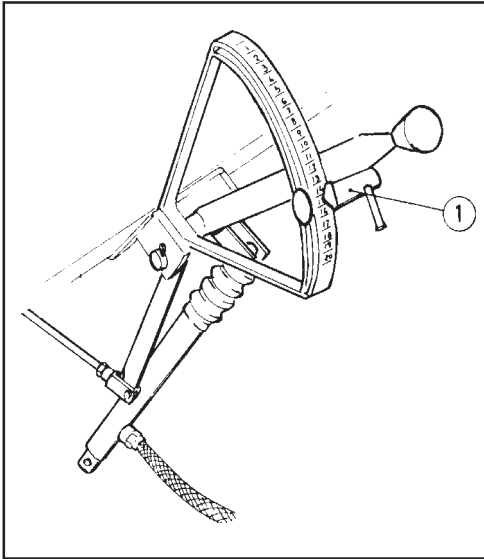

As we know the dose we need and also the working width, we look for the case about the correct dose (kg/ha) in the column concerning to the working width and to the working speed.

When we have the correct dose, we go by the same row until the column on the left of the table, where we are going to read the position of the adjustment lever.

For example, we are going to continue on the case of page 14: we want to fertilize with nitrate NAC 26% to 150 kg/ha and speed 8 km/h, working width 18 m.

We look for on the column of 18m working width and 8 km/h speed the case refers 150 kg/ha. On the left column of the table we read the position of the adjustment lever: 7.

m		12						15						18					
Kg/min	Kg/min	Kg/Ha				Kg/Ha	Kg/Ha				Kg/Ha	Kg/Ha				Kg/Ha			
		6	8	10	12		6	8	10	12		6	8	10	12				
4	3	50	38	30	25		40	30	24	20		33	20	17					
5	7	117	88	70	58	B3	93	70	56	47	B2	78	47	39	XB2				
6	11	183	138	110	92	C4	147	110	88	73	C4	122	73	61	C4				
7												158	127	105					
8	26	433	325	260	217		347	260	208	173		289	217	173	144				



When we give pressure to the cylinder release, the fertilizer exit devices close (lever 1 goes to zero). When we eliminate pressure, the cylinders return to the pre-established position with the selection check and open the exit devices with the flow required.

By means of two control valves we can choose one of the following options:

- All machine, that is, two disc are working at the same time. (Two valves have to be open)
- Half right (only a disc - only a valve is open)
- Half left (only a disc - only a valve is open)

If we want to work only with half machine, it is necessary to give pressure to the cylinders, and then, to close the control valve we want put out of action.

During the long displacements with the fertilizer spreader well full, it is necessary, one time closed fertilizer exit devices, to close two valves to avoid the fertilizer leakage by fertilizer exit devices.

## 6. EDGES FERTILISED

For fertilizing the land edges it is necessary to start the work just in the land limit, closing the fertilizer exit device concerning to the limit side. We can do this operation, working the hydraulic control valves in the way we have seen in the previous page.

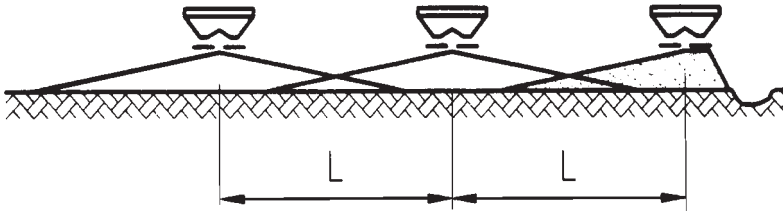

Fertilised distribution in the limit of the land.

## 7. FLOW TEST

To know the fertilizer flow, spreaded by the fertilizer spreader, we will do a test. We will control the quantity comes out by a fertilizer exit device during a minute (we have this information on the dosage tables. Pages 21 to 23). When the flow will be fixed, the quantity to spread per hectare will depend only on working speed and the runs width.

Find as follows the points for doing the test:

- Detach to the right disc
- Place a container under the hopper exit device to collect the fertilizer.
- Turn the power take-off to 540 r.p.m.
- Place the adjuster stop in the correct position.
- Open the right side fertilizer exit device during a minute.
- W Weight the collected fertiizer (we will obtain kg/min).

Para obtener el caudal en kg/ha aplicaremos la siguiente f rmula:

$$\text{DOSE (kg/ha)} = \frac{1200 \times \text{flow (kg/min)}}{\text{speed (km/h)} \times \text{working width (m)}}$$

Verify the adjuster and repeat these operations for obtaining the flow desired.

## 8. GREASING AND MAINTENANCE

- Every day, the shaft of the power take-off must be lubricated with grease.
- The gear box are greased with type NLGI 00 (lithium grease EP 00). Verify very often the level  
Verify often the level of the grease.
- Lubricate with oil the articulations of the levers and joints.
- It is necessary to wash the fertilizer spreader with water after use it.
- If the fertilizer spreader must be stocked during a long time, it is necessary to protect the machine with protective coverings (oil, corrosion inhibitor).

## 9. DOSAGE TABLES

In the dosage tables we can find the spreaded dose in kg/ha for each type of fertilizer, depending on the working width and the working speed.

Quantities we find are for guidance only. The flow can change depending on fertilizer granulometry, density, humidity, etc.

For fertilizers do not found in the list, we can follow the same criterion to look for the most similar in granulometry and density.

### SYMBOLS USED IN THE TABLES

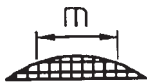

= Working width or working distance.



= Position of the adjustment lever.

**Kg/min**

= Exit device flow, in kg per minute.





**Km/h**

= Working speed in kms per hour.



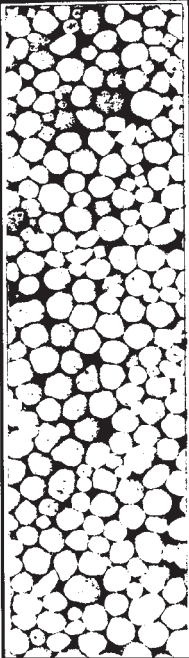



= Blades position on the disc.

DOSAGE TABLES

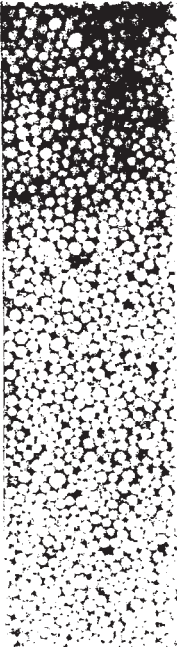
abono: <b>NITRATO AMONICO CÁLCICO 26%</b> densidad: 1.02 kg/dm <sup>3</sup> granulometría: Ø 4,75=9% Ø 3,3=72% Ø 2 =12% Ø <2 =2%													
		12				15				18			
		 Kg/min	Km/h			 Kg/Ha	Km/h			 Kg/Ha	Km/h		
	6		8	10	12		6	8	10		12	6	8
4	3	50	38	25		40	30	24	20	33	25	20	17
5	7	117	88	58	<b>B3</b>	93	70	56	47	78	58	47	39
6	11	183	138	92	<b>C4</b>	147	110	88	73	122	92	73	61
7	19	317	238	158		253	190	152	127	211	158	127	105
8	26	433	325	217		347	260	208	173	289	217	173	144
9	36	600	450	300	<b>B2</b>	480	360	288	240	400	300	240	200
10	46	766	575	460	<b>C5</b>	613	460	368	306	511	383	306	255
11	57	950	713	475		760	570	456	380	633	475	380	316
12	68	1133	850	566		906	680	544	453	755	566	453	377
13	81	1349	1013	675		1080	810	648	539	900	675	539	450
14	93	1549	1163	775		1240	930	744	619	1033	775	619	516
15	100	1666	1250	833	<b>XA3</b>	1333	1000	800	666	1111	833	666	555
16	108	1799	1350	900	<b>C4</b>	1440	1080	864	719	1200	900	719	599
17	110	1833	1375	916		1466	1100	880	733	1222	916	733	611
18	115	1916	1438	958		1533	1150	920	766	1278	958	766	638
19	118	1966	1475	983		1573	1180	944	786	1311	983	786	655
20	121	2016	1513	1008		1613	1210	968	806	1344	1008	806	672



abono: <b>UREA 46% N</b> densidad: 0,770 kg/dm <sup>3</sup> granulometría: Ø 4,75=0% Ø 3,3=20% Ø 2 =79% Ø<2 =1%																												
								9						12														
	Kg/min	Km/h						Kg/Ha																				
		6	8	10	12	6	8	10	12	6	8	10	12															
	4	2	44	33	27	22	33	25	20	17																		
	5	9	200	150	120	100	150	113	90	75																		
	6	13	289	217	173	144	217	163	130	108																		
	7	21	467	350	280	233	350	263	210	175																		
	8	28	622	466	373	311	466	350	280	233																		
	9	37	822	616	493	411	616	463	370	308																		
	10	46	1022	766	613	511	766	575	460	383																		
	11	55	1222	916	733	611	916	688	550	458																		
	B1 C5														B2 D4													



---

## 10. SPARE PARTS

The terms RIGHT (derecha), LEFT (izquierda), FRONT (delante) and iBACK (detrás) refers to the machine in starting direction.

In drawings we do not repeat the same spare parts, but with different hand. Codes are in spare parts chapters.

Please, when you order the spare parts, inform about the code and machine type. You will find it on the hopper identification nameplate.



Be careful to change the elements of the sowing equipment, because the sharp elements can cause injuries.

As a general instruction, you must avoid working under the machine hanged up from the tractor. If you must do it, be extremely careful and secure it.

## 10.1 GROUPE TRANSMISSION

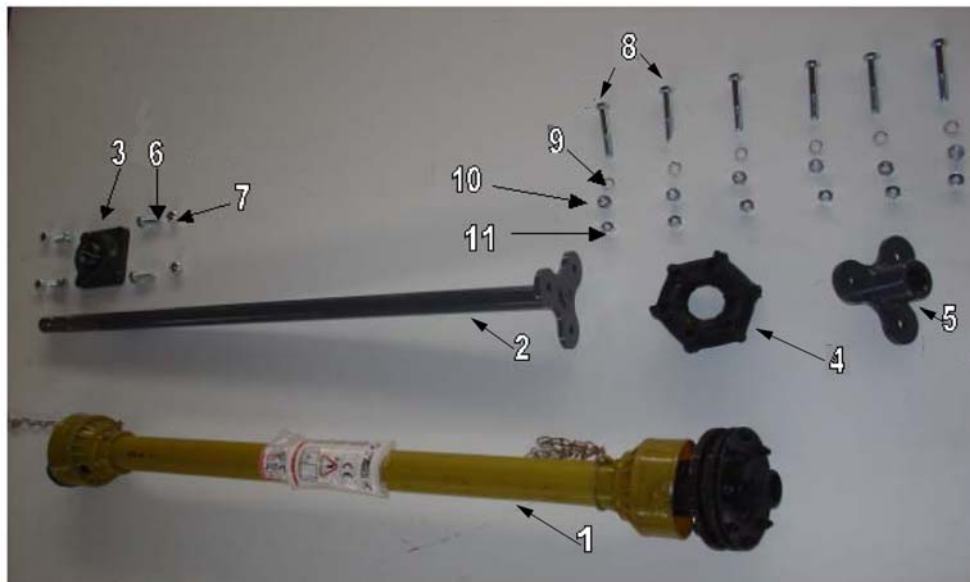

N°	COD
1	VI-4911021
2	VI-045824
3	VI-045825
4	VI-4799015
5	VI-045826
6	933 14X40 6.8 Z
7	985 14
8	931 12X80 6.8 Z
9	VI-4600343
10	934 12 Z
11	985 12

## 10.2. AGITATEUR



N°	COD
1	PS-2812
2	PS-2806
3	PS-2804
4	931 8X45 I
5	985 8 I
6	93 8X25 I
7	125 8 I
8	985 8 I

---

## 10.3. PROTECTION DERRIERE



N°	COD
1	VI-045823
2	603 8X20 I
3	934 8 I

---

## 10.4. PROTECTION TRANSMISSION



N°	COD
1	VI-045822
2	603 8X20 I
3	125 8 I
4	985 8

## 10.5. GROUPE GRADUATION

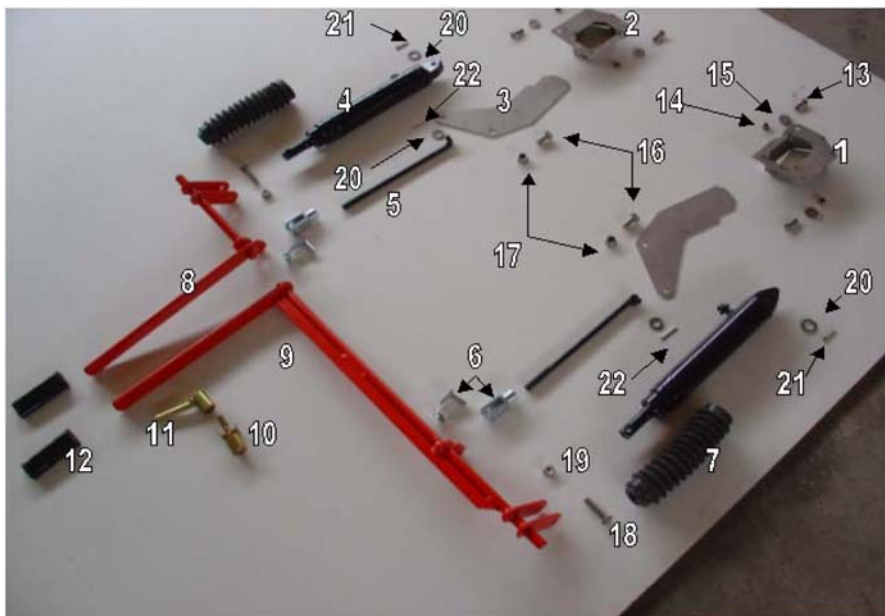

N°	COD
1	PS-045301/D
2	PS-045301/I
3	PX-045312
4	CO-045101
5	PS-2817
6	FE-610001
7	PL-045101
8	VI-045820
9	VI-045821
10	PS-045110
11	PS-045407
12	PL-040203
13	933 8X25 I
14	985 8 I
15	9021 8 I
16	933 12X25 I
17	985 12 I
18	933 10X45 I
19	985 10 I
20	125 14 I
21	FE-610015
22	FE-610016

---

## 10.6. DIFFUSEUR



N°	COD
1	VI-045818
2	933 8 I
3	935 8 I
4	9021 8 I
5	125 8 I

## 10.7. MACHINE COMPLETE



N°	COD
1	VI-075802
2	VI-075803
3	VI-6201519
4	CO-095800
5	VI-5900010



10.8. COMMANDE HYDRAULIQUE OUVERTURE ET FERMETURE

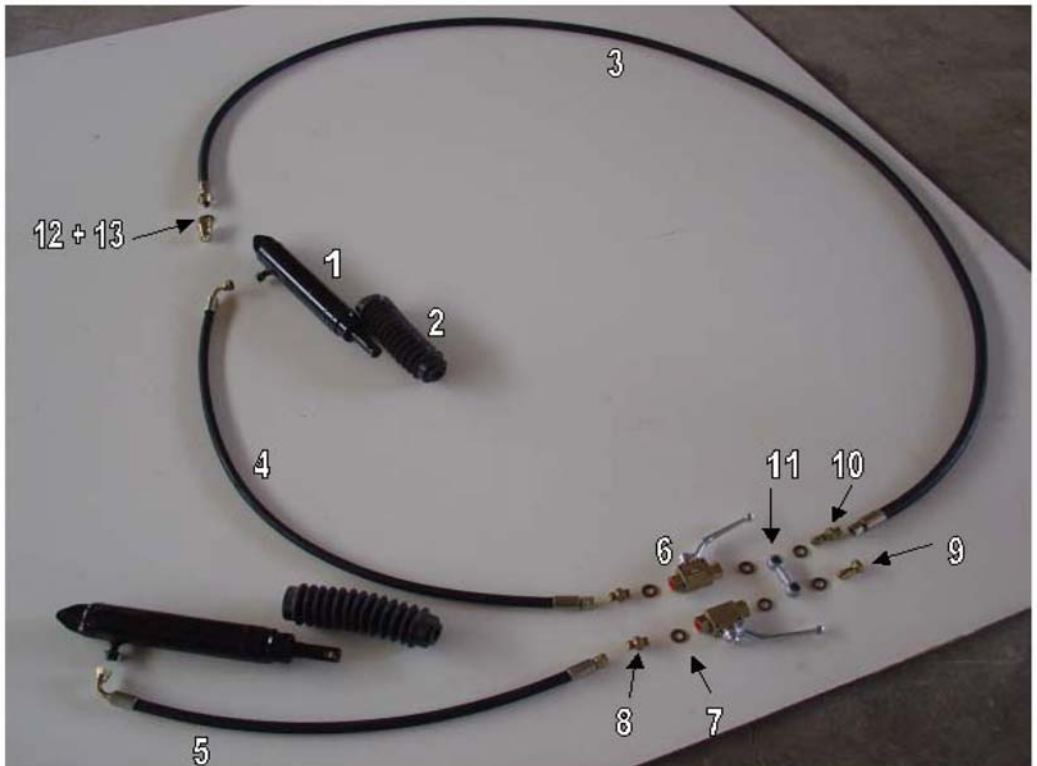

N°	COD
1	CO-045101
2	PL-045101
3	VI-4905745
4	VI-4905305
5	VI-4905300
6	VI-4907010
7	HI-705006
8	VI-4900002
9	VI-4900710
10	VI-4900800
11	VI-045819
12	VI-4908230
13	HI-705007

## 10.9. GROUPE FREIN

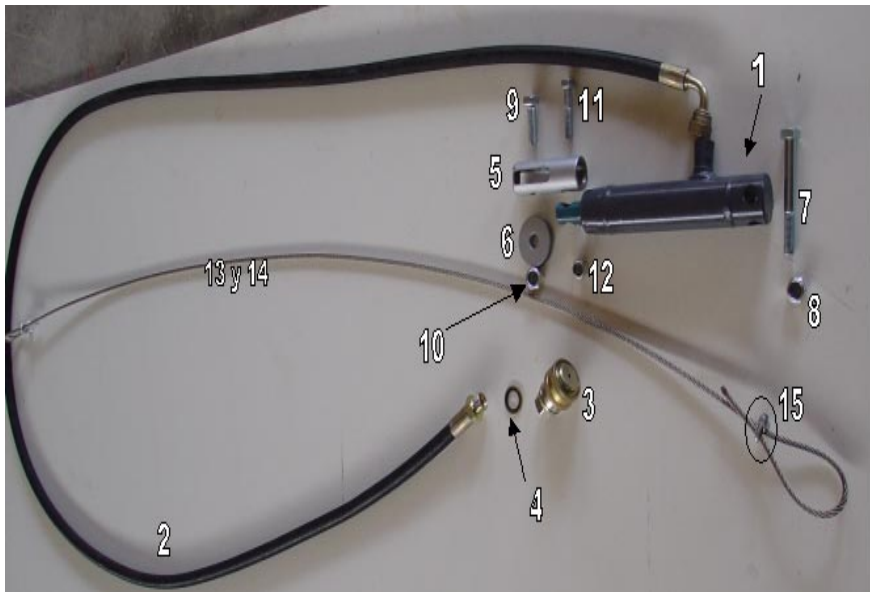

N°	COD
1	VI-4912010
2	VI-4905750
3	HI-701006
4	HI-705002
5	VI-4912012
6	VI-4912015
7	931 16X90 Z
8	985 16
9	933 14X50 Z
10	985 14
11	933 12X50 Z
12	985 12
13	VI-015800
14	VI-015801
15	VI-4600645

## 10.10. EQUIPEMENT

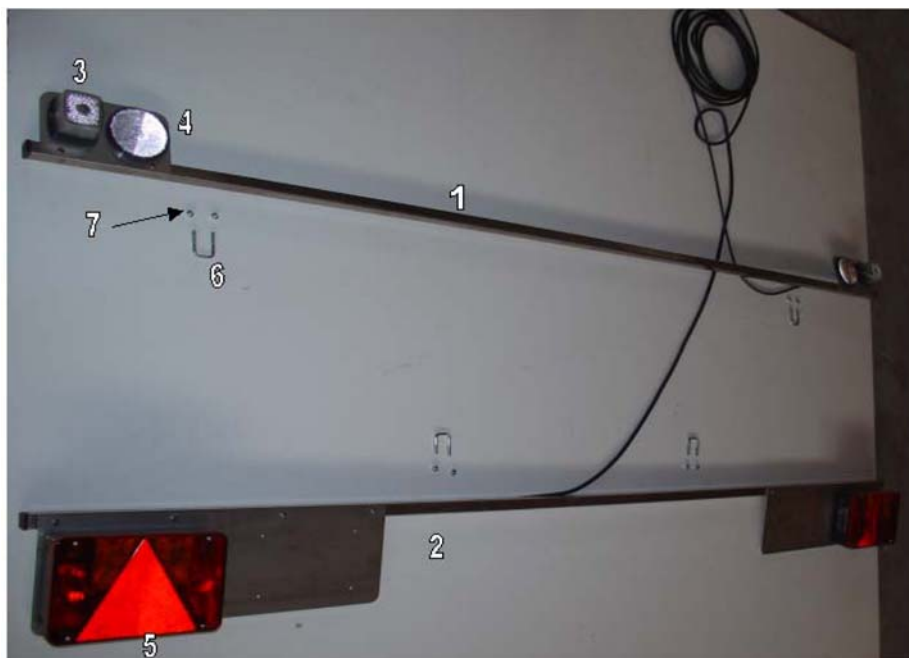

N°	COD
1	VI-8000044
2	VI-8000043
3	VI-8000145
4	VI-8000179
5	VI 8000120
6	FE-614030
7	985 6 I

## 10.11.EQUIPEMENT DISTRIBUTION

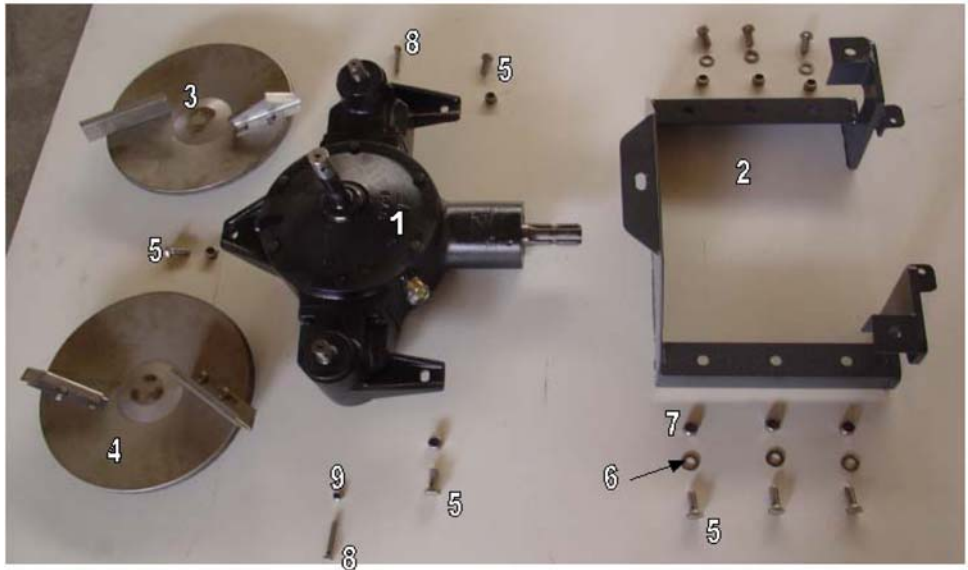

N°	COD
1	CO-045300
2	VI-045817
3	MO-2803/D
4	MO-2803/I
5	933 12X30 I
6	125 12 I
7	985 12 I
8	931 8X45 I
9	985 8 I





MAQUINARIA AGRICOLA SOLA,S.L.  
Ctra. de Igualada s/n. Apdo.Correos,11  
08280 CALAF (Barcelona) ESPAÑA  
Tel.34 93 868 00 60\*  
Fax. 34 93 868 00 55  
[www.solagrupo.com](http://www.solagrupo.com)  
e-mail:[sola@solagrupo.com](mailto:sola@solagrupo.com)