



ARES-2713

Pneumatic seed drill



STARTING MANUAL

MAINTENANCE AND DOSAGE

WWW.SOLAGRUPO.COM

SOLÀ seed drills and fertilizer spreaders are manufactured in a highly specialized environment and our factory has a vast customer-endorsed experience.

SOLÀ machines use highly advanced technology and are guaranteed to work without malfunction in a great variety of conditions. They are provided with easy-to-use and efficient devices.

SOLÀ machines perform excellently with only minimum operator maintenance.

*This manual will help you use your **SOLÀ** product with the utmost efficiency.*



Certified quality system

3rd Edition – June 2017
Ref.: CN-811082/GB
Created by: M.A SOLÀ, S.L.

It is forbidden to copy any part of this manual.
Specifications are subject to change or modification without notice.
The pictures included do not necessary show the standard version.

TABLE OF CONTENTS

1- INTRODUCTION	5
2- GENERAL DESCRIPTION OF THE MACHINE	6
2.1 OVERVIEW	6
2.2 STANTDARD EQUIPAMENT	6
2.3 OPTIONAL EQUIPAMENT	6
2.4 TECHNICAL CHARACTERISTICS	7
3- SAFETY INSTRUCTIONS	9
3.1 SAFETY SYMBOLS.....	9
3.2 USE ACCORDING TO DESIGN.....	9
3.3 GENERAL SAFETY INSTRUCTIONS.....	10
4- ESSENTIAL SOWING CONCEPTS	11
4.1 TERRAIN.....	11
4.2 THE SEED.....	11
4.3 SEED PLANTING DEPTH	11
5- STARTING	13
5.1 COUPLING THE SEED DRILL	13
5.2 ELECTRICAL CONNECTIONS.....	13
5.3 HYDRAULIC CONNECTIONS	14
5.3.1 HYDRAULIC SYSTEM.	14
5.4 TRANSPORT POSITION	15
5.5 LOADING THE SEED DRILL MANUALLY	16
5.6 THE BUILT-IN SUPPORTING LEGS.....	16
6- DOSAGE	17
6.1 REGULAR SEEDS (POSITION N)	18
6.2 FINE SEEDS (MICRODOSING – POSITION F).....	18
6.3 PREVIOUS FLOW TEST.....	19
6.4 COMPLEMENTARY CHECKING TESTS	20
6.4.1 TEST TO DETERMINE THE NUMBER OF WHEEL TURNS.....	20
6.4.2 SEED DOSING ADJUSTMENTS	21
7- ADJUSTING SEED PLANTING DEPTH	22
7.1 ADJUSTING RATCHETS AND SPINDLES	22
7.2 INCLINATION OF THE FOLDING PARTS	22
7.3 TRACK ERASERS.....	23
7.4 LEVELLER (OPTIONAL)	23
7.5 SEEDING ARM.....	23
7.5.1 TINE COULTER	23
7.5.2 PT	23
7.5.3 DISCO	24
7.5.4 SUFFOLK COULTERS	24
7.5.5 DOUBLE DISC	24
7.6 HARROW	25
7.7 HYDRAULIC TRACK MARKERS.....	25
7.7.1 ADJUSTING TRACK MARKER'S LENGTH.	25
7.7.2 ADJUSTING TRACK MARKER'S INCLINATION.	26

8- TYPES OF DISTRIBUTION	27
8.1 SEED DISTRIBUTION BY MECHANICAL FAN.....	27
8.2 SEED DISTRIBUTION BY HYDRAULIC FAN.....	27
9- ELECTRONICAL CONTROLLER	28
9.1 FRONT PANEL DESCRIPTION	28
9.2 FORWARD SPEED – C1	28
9.3 TOTAL AREA / SEED DRILL WIDTH – C2.....	29
9.4 CONTROL PANEL WITH MARKER PATHS (OPTIONAL)	29
9.4.1 TRAMLINING - C3	29
9.5 FAN RPM / FAN ALARMS – C4.....	32
9.6 SEED SHAFT RPM – C5	32
9.7 HOPPER LOW LEVEL ALARM – C6.....	32
9.8 TOTAL SOWING SHUT-OFF (OPTIONAL)	33
9.9 SHUT-OFF SOWING FROM FOLDING PARTS (OPTIONAL)	33
10- MAINTENANCE	34
10.1 CHECKING FREQUENCY	34
10.2 LUBRICATION	35
10.3 DISTRIBUTOR HEAD AND SEED HOSES	35
10.4 TYRES PRESSURE.....	35
11- DOSAGE TABLES	36

1. INTRODUCTION

It is essential to read and follow the instructions and recommendations in this manual before operating the seed drill **ARES-2713**. Careful reading enables maximum operator efficiency, prevents accidents and damage, and increases the seed drill's capacity and life expectancy.

The manual should be read by everyone performing operational (including preparation, repairs in the field and general care of the machine), maintenance (inspection and technical assistance) and transportation tasks.

Please ensure that this manual has been read by any person involved in performing **operational tasks**, (including preparation, dealing with mechanical problems and supervising the machine), **maintenance** (inspection and technical assistance) and **transport**.

For your safety, please follow these technical safety instructions as **SOLÀ** will not be responsible for damages caused by not observing the information provided.

In the first chapters you will find the Technical Characteristics and Safety Instructions, as well as some essential sowing concepts. Basic concepts that are required to operate the machine are explained in the Starting and Maintenance sections.

The last part of this manual consists of Dosage Tables, detailed by seed type.



SOLÀ RETAINS THE RIGHT TO MODIFY ILLUSTRATIONS, TECHNICAL DATA AND WEIGHTS INDICATED IN THIS OPERATING MANUAL, IF THESE CHANGES HELP TO IMPROVE THE QUALITY OF THE SEED DRILLS.

In this operating manual you will find three different symbols relating to safety:



TO WORK MORE EASILY WITH THE SEED DRILL.



TO PREVENT DAMAGE TO THE SEED DRILL AND OPTIONAL EQUIPMENT.



TO PREVENT PHYSICAL INJURY.

2- GENERAL DESCRIPTION OF THE MACHINE

2.1 OVERVIEW

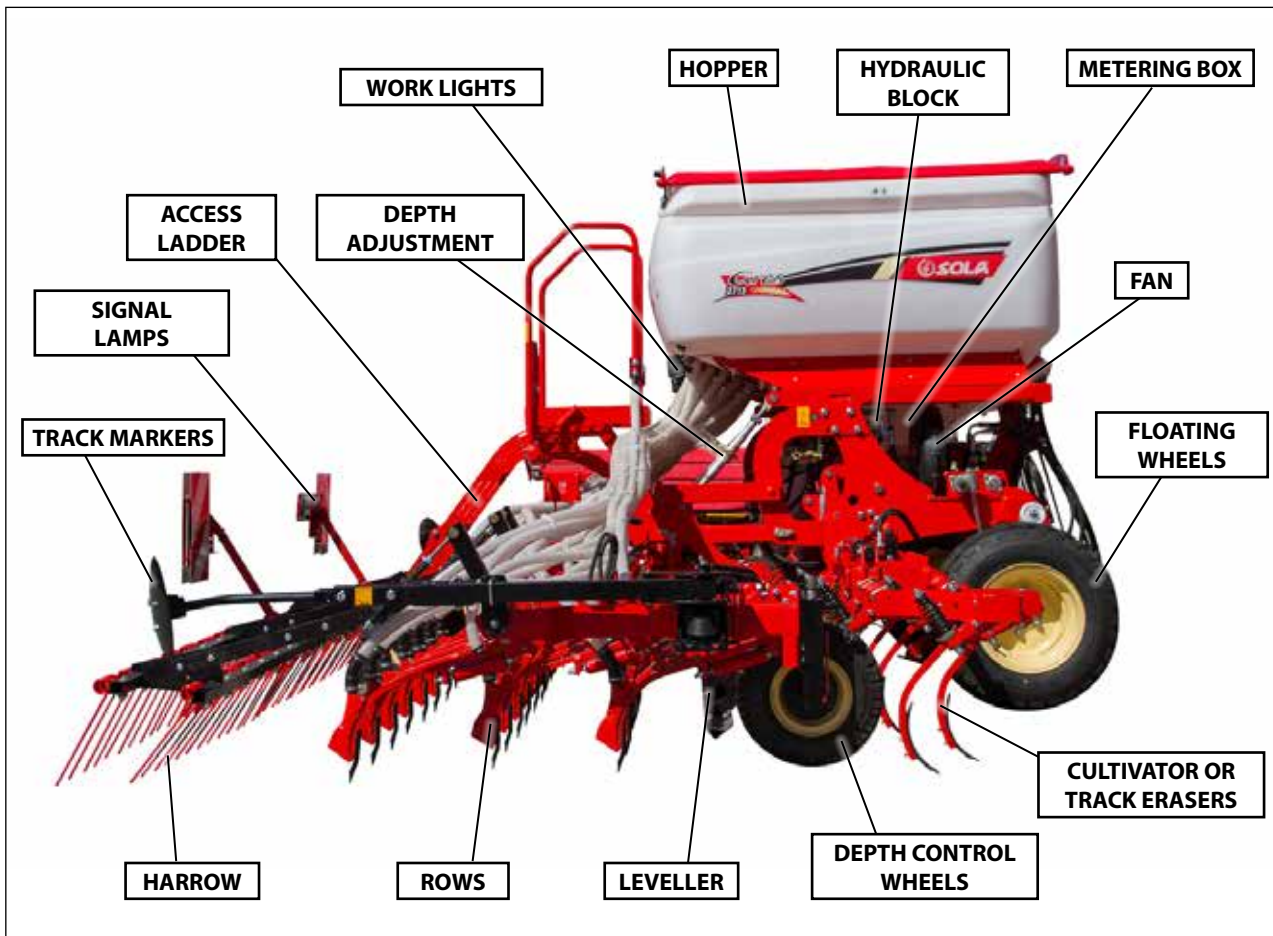

2.2 STANDARD EQUIPMENT

- Hopper with a capacity of 1600 or 2000 litres.
- Selector screen.
- Weigher, crank and grain counter.
- Tractor track eraser and seed drill or rear cultivator.
- Monitor with fan rpm counter, distributor turning alarm, hopper seed level sensor, and hectare counter.
- Signal, marker, brake and clearance lamps.
- Work lamps.
- Rear harrow in three lengths.
- Mechanical fan with cardan transmission at 1000 rpm or fan with hydraulic motor.
- Floating wheels 10.0/75-15.3 with mud scrapers.
- Wheels on the folding parts for depth control (* available for models 500 and 600 only).

2.3 OPTIONAL EQUIPMENT

- Central wheels for depth control.
- Mud scrapers for the depth-control wheels on folding parts.
- Individual depth control wheel for each row (available for the DISC model only).
- Flat or tine leveller in three lengths.
- Electric transmission with radar or GPS.
- Total power cutout.
- Shut-off sowing from dependent or independent folding parts or shut-off half machine.
- Tramlines.
- Microgranulator kit (400 additional litres).
- Pre-emergence track markers.
- Independent hydraulic kit.
- Independent hydraulic track markers.

2.4 TECHNICAL CHARACTERISTICS

TYPE OF MACHINE	LINES	WORKING WIDTH (cm) / ROWS	SPACING ROW (cm)	HOPPER CAPACITY (L.)	TRANSPORT WIDTH (m)	HEIGHT MAX. (m)	TARE WITH TRACK ERASER (kg)	TARE WITH CULTIVATOR (kg)
TINE COULTER	3	400/32	12,5	1.600 or 2.000	3,05	2,40		2.070
		450/36			3,05	2,40		
		500/40			3,05	2,60		
		600/48			3,05	3,05	1.760	2.200
	4	400/32	12,5	1.600 or 2.000	3,05	2,40		
		450/36			3,05	2,40		
		500/40			3,05	2,60		
		600/48			3,05	3,05	1.960	
		700/48			3,05	3,55	2.040	

TYPE OF MACHINE	LINES	WORKING WIDTH (cm) / ROWS	SPACING ROW (cm)	HOPPER CAPACITY (L.)	TRANSPORT WIDTH (m)	HEIGHT MAX. (m)	TARE WITH TRACK ERASER (kg)	TARE WITH CULTIVATOR (kg)
PT	3	400/32	12,5	1.600 or 2.000	3,05	2,40		
		450/36			3,05	2,40		
		500/40			3,05	2,60		
		600/48			3,05	3,05		
	4	400/32	12,5	1.600 or 2.000	3,05	2,40		
		450/36			3,05	2,40		
		500/40			3,05	2,60	1.910	
		600/48			3,05	3,05	1.960	

TYPE OF MACHINE	LINES	WORKING WIDTH (cm) / ROWS	SPACING ROW (cm)	HOPPER CAPACITY (L.)	TRANSPORT WIDTH (m)	HEIGHT MAX. (m)	TARE WITH TRACK ERASER (kg)	TARE WITH CULTIVATOR (kg)
SUFFOLK	2	400/32	12,5	1.600 or 2.000	3,05	2,40		
		450/36			3,05	2,40		
		500/40			3,05	2,75		2.250
		600/48			3,05	3,20		
	3	400/32	12,5	1.600 or 2.000	3,05	2,40		
		450/36			3,05	2,40		
		500/40			3,05	2,60		
		600/48			3,05	3,05		

TYPE OF MACHINE	LINES	WORKING WIDTH (cm) / ROWS	SPACING ROW (cm)	HOPPER CAPACITY (L.)	TRANSPORT WIDTH (m)	HEIGHT MAX. (m)	TARE WITH TRACK ERASER (kg)	TARE WITH CULTIVATOR (kg)
DISCS	2	400/32	12,5	1.600 or 2.000	3,05	2,40		
		450/36			3,05	2,40		
		500/40			3,05	2,75		
		600/48			3,05	3,20	2.080	

TYPE OF MACHINE	LINES	WORKING WIDTH (cm) / ROWS	SPACING ROW (cm)	HOPPER CAPACITY (L.)	TRANSPORT WIDTH (m)	HEIGHT MAX. (m)	TARE WITH TRACK ERASER (kg)	TARE WITH CULTIVATOR (kg)
DOUBLE DISC	2	400/32	12,5	1.600 or 2.000	3,05	2,40		
		450/36			3,05	2,40		
		500/40			3,05	2,75		
		600/48			3,05	3,20		

3. SAFETY INSTRUCTIONS

3.1 SAFETY SYMBOLS

On the machine you will find the following warning pictograms:



READ THE INSTRUCTIONS CAREFULLY AND OBSERVE THE SAFETY ADVICE GIVEN IN THE OPERATING MANUAL.



IT IS FORBIDDEN TO RIDE ON THE MACHINE DURING OPERATION.
RISK OF SERIOUS PHYSICAL INJURY.



DURING THE COUPLING MANOEUVRE, STAY AWAY FROM THE REAR PART OF THE TRACTOR.
RISK OF SERIOUS PHYSICAL INJURY.



RISK OF BEING CRUSHED WHEN WORKING UNDER THE MACHINE, PLEASE SECURE THE MACHINE TO PREVENT THIS RISK.
RISK OF SERIOUS PHYSICAL INJURY.



DANGER OF INFECTION FROM ESCAPING HYDRAULIC FLUID AT HIGH PRESSURE! THIS CAN INFLICT SERIOUS INJURIES WITH POTENTIALLY FATAL CONSEQUENCES IF IT PASSES THROUGH THE SKIN AND INTO THE BODY. KEEP THE HOSE LINES IN GOOD CONDITION.
RISK OF SERIOUS PHYSICAL INJURY.



THE DIRECTION AND SPEED THAT THE PTO SHAFT TURNS (ONLY IN MACHINES EQUIPPED WITH MECHANICAL FAN).



NEVER STAND UNDER THE SOWING EQUIPMENT OR SWIVEL AREA OF THE MACHINE'S EXTENSION TINE COULTERS.
RISK OF SERIOUS PHYSICAL INJURY.



NEVER STAND UNDER THE TRACK MARKERS NOR INSIDE THEIR ACTION AREA.
RISK OF SERIOUS PHYSICAL INJURY.



WHILE MAINTAINING OR REPAIRING THE SEED DRILL, STOP THE TRACTOR'S ENGINE AND PREVENT IT FROM STARTING. THE IGNITION KEY MUST BE REMOVED.



COUPLING POINT FOR TRANSPORTATION BY CRANE.

2.2 USE ACCORDING TO DESIGN

- The Seed Drill **ARES-2713** has been designed for cereal and other kind of grain seeds.

- If the machine is used in circumstances other than the above, the manufacturer will not be held responsible for any damage caused.

- The user must observe all regulations concerning safety, traffic and hygiene.

- If the machine is modified by the user, the manufacturer's warranty is cancelled. **SOLÁ** will not be held responsible for any damage caused.

2.3 GENERAL SAFETY INSTRUCTIONS



- BEFORE STARTING THE MACHINE, PLEASE CHECK THE MACHINE IS IN GOOD CONDITION FOR WORK AND IS SAFE FOR ROAD USE.



- CHECK THAT VISIBILITY IS CLEAR AROUND THE MACHINE AND THERE IS NO PERSON IN THE WORKING AREA.



- IN THOROUGHFARE, PLEASE OBSERVE TRAFFIC SIGNS AND REGULATIONS.



- IT IS FORBIDDEN TO RIDE ON THE MACHINE OR CLIMB INTO THE MACHINE WHEN IT IS RUNNING.



- BEFORE USING THE MACHINE, THE USER MUST BE FAMILIAR WITH ALL OPERATING ELEMENTS.



- PLEASE BE EXTREMELY CAREFUL WHEN COUPLING AND UNCOUPLING THE MACHINE TO THE TRACTOR.



- PLEASE CHECK THAT THE PTO SHAFT IS IN GOOD CONDITION AND WELL PROTECTED. PREVENT THE PROTECTIVE TUBE FROM TURNING BY HOLDING BOTH THE TUBE AND CHAIN PROVIDED FOR THIS PURPOSE.



- MOUNT THE PTO SHAFT'S TRANSMISSION ONLY WHEN THE TRACTOR'S ENGINE IS OFF.



- BEFORE CONNECTING THE PTO SHAFT, BE SURE THAT THE DANGER ZONE SURROUNDING THE MACHINE IS CLEAR.



- NEVER LEAVE THE TRACTOR'S DRIVER'S SEAT WHILE THE MACHINE IS IN OPERATION.



- DO NOT DEPOSIT EXTERNAL ELEMENTS INSIDE THE HOPPER.



- WHEN MAINTAINING THE HYDRAULIC SYSTEM OF THE SEED DRILL, MAKE SURE THAT IT IS DEPRESSURISED AND THE TRACTOR'S ENGINE IS OFF.



- PLEASE REGULARLY CHECK THE CONDITION OF THE TUBES AND HOSEPIPES IN THE HYDRAULIC SYSTEM. THESE PARTS AGE NATURALLY AND THEIR LIFE SHOULD NOT EXCEED 6 YEARS. PLEASE REPLACE WHEN NECESSARY.



- WHEN RAISING THE SEED DRILL, THE FRONT AXLE IS UNLOADED. ENSURE THAT THE MACHINE HAS ENOUGH LOAD TO PREVENT IT OVERTURNING. AT THIS TIME YOU MUST ENSURE THAT THE CONDITION OF BOTH THE STEERING AND THE BRAKES IS OPTIMAL.



- DURING TRANSIT WITH THE RAISED SEED DRILL, BLOCK THE LOWERING SWITCH. BEFORE LEAVING THE TRACTOR, LOWER THE SEED DRILL ONTO THE GROUND AND REMOVE THE TRACTOR'S STARTING KEY.



- ALWAYS USE ENOUGH SUPPORTING ELEMENTS WHEN MAINTAINING THE MACHINE IN A RAISED POSITION TO PREVENT THE MACHINE FROM LOWERING OR FALLING.

4. ESSENTIAL SOWING CONCEPTS

4.1 TERRAIN



THE BETTER THE SOIL CONDITION, THE BETTER THE SOWING QUALITY. WORK IS MORE DIFFICULT ON BIG CLODS OR UNEVEN FURROWS. ALTHOUGH **SOLA** MACHINES RESIST HARSH CONDITIONS, IF THE SEEDBED DOES NOT SATISFY APPROPRIATE CONDITIONS THEN THE SOWING QUALITY WILL SUFFER.

4.2 THE SEED



IT IS ESSENTIAL THAT SEEDS ARE WELL MAINTAINED AND CLEAN. BARLEY SEEDS SHOULD BE TRIMMED.

4.3 SEED PLANTING DEPTH



THE RECOMMENDED SEED PLANTING DEPTHS ARE FROM 3 TO 5 CENTIMETRES. PLANTING TOO DEEP CAUSES PROBLEMS AS RHIZOME CANNOT REACH THE SURFACE AND THE PLANT WILL DIE. IT DOES NOT MATTER THAT SOME GRAINS ARE VISIBLE BECAUSE THE HARROW'S. TINES WILL COVER THEM EVENTUALLY.

The seed planting depth has consequences for tillering, as well as for the plant's strength and its ability to resist frostbite or drought. The parent shoot grows from 1 to 2 cm under the ground, whatever the depth of the seed.

Planting deeper does not necessarily mean getting deeper roots. Only a few roots grow from the lower part of the seed. Most of them grow from a parent shoot close to ground level.

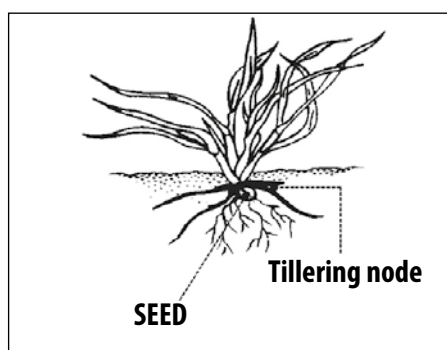

Normal Planting Depth: from 2 to 4 cm

- Thick stem, short rhizome and resistant to frostbite.
- Multiple tillering providing from 3 to 6 shoots and a lot of blades, from 6 to 10.
- Deep and thick roots, approximately 5 cm in width and 10-12 cm in depth.
- With less grains per sowing square metre, more ears are obtained.

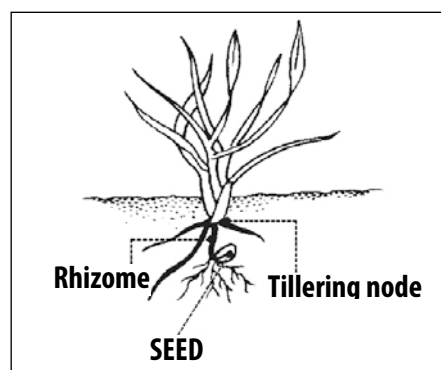

Deeper Planting: from 5 to 6 cm

- Fine stem, rhizome exposed to frostbite.
- Late and weak tillering, 1 or zero shoots and only a few blades, 3-4 aprox.
- Medium quality roots of approximately 3 cm in width and 5 cm in depth.
- More grains per sowing square metre are required to obtain the same number of ears as in the previous case.

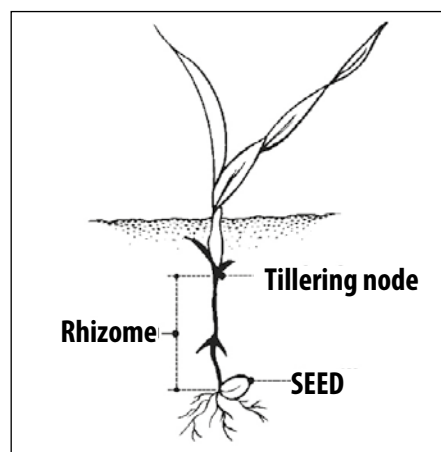

Very deep planting: from 8 to 10 cm

- Very fine stem. No tillering and only one blade.
- Seed runs out of supplies by growing a long rhizome which frostbite can easily cut.
- The plant takes weak roots, approximately 1 cm in width and 3 cm in depth.
- Twice the number of grains per sowing metre are required to obtain the same number of ears as in the first case.

WARNING



IN VERY COLD PLACES, REPEATED FROSTBITE CAN HAVE A HONEYCOMB EFFECT ON THE GROUND'S MOST SUPERFICIAL LAYER. IN THIS CASE THE PLANT'S VERY FIRST ROOTS CAN LOOSEN AND THE PLANT WILL DIE. SLIGHTLY DEEPER PLANTING IS RECOMMENDED AND IF POSSIBLE, THE USE OF ROLLERS TO COMPACT THE EARTH TO BETTER PROTECT THE SEEDS.



WHEN STARTING THE MACHINE, FURROWS WILL NOT CONTAIN ANY SEEDS FOR A METRE. WHEN STOPPING THE MACHINE, SEEDS WHICH WERE PREVIOUSLY INSIDE THE SEED HOSES, SLIDE FROM THE MACHINE AND END UP PILED ON THE GROUND. TAKE THIS INTO ACCOUNT WHEN STOPPING AND STARTING THE MACHINE IN ORDER TO ACHIEVE MORE ACCURACY.



ALWAYS WORK AT A UNIFORM SPEED AS SUDDEN ACCELERATING AND SLOWING DOWN WILL CAUSE AN IRREGULAR SEED DISTRIBUTION.

5. STARTING

5.1 COUPLING THE SEED DRILL

Seed drill **ARES-2713** is supplied with a three-point linkage of category 3.



MAKE SURE THAT NO PERSON OR OBJECT IS EVER BETWEEN THE SEED DRILL AND THE TRACTOR WHEN COUPLING BOTH MACHINES.



TO COUPLE THE SEED DRILL AND THE TRACTOR, FOLLOW THESE STEPS:

Place the fast-locking balls in the two lower bolts.

Next, couple the fertilizer using the three-point linkage.

Once the seed drill is coupled with the tractor, **THE PTO SHAFT SHOULD BE ADAPTED:**

- 1- Dismount and insert one end into the tractor's universal joint shaft and the other end into the seed drill. Look for the minimal movement length "L" by raising and lowering the hydraulic lift.
- 2- Cut the spare plastic and metal into parts of the same length and remount the PTO shaft.
- 3- Operate the hydraulic lift and check that the PTO shaft's movement is correct.
- 4- Secure the PTO shaft using the chain.
- 5- Connect the hydraulic hoses and the electrical connector to the tractor. Feed the monitor cable into the tractor cabin and connect the monitor.

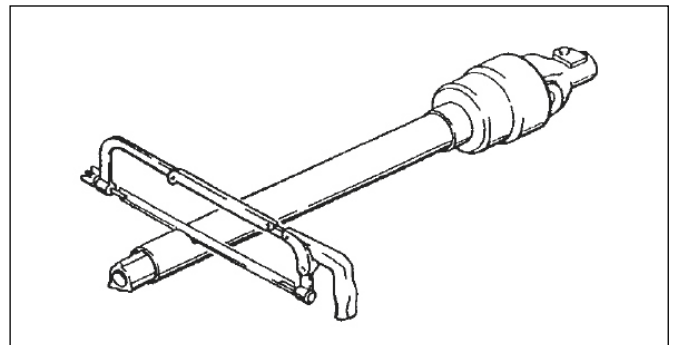
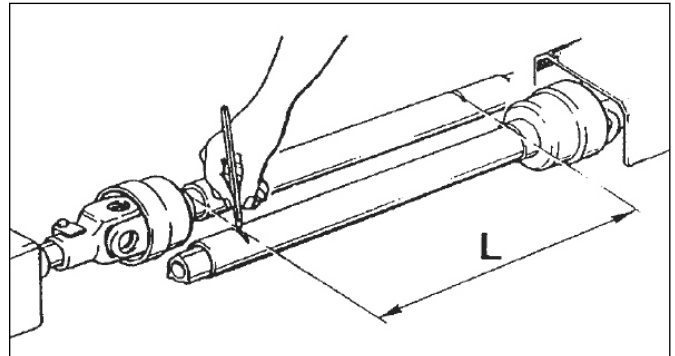
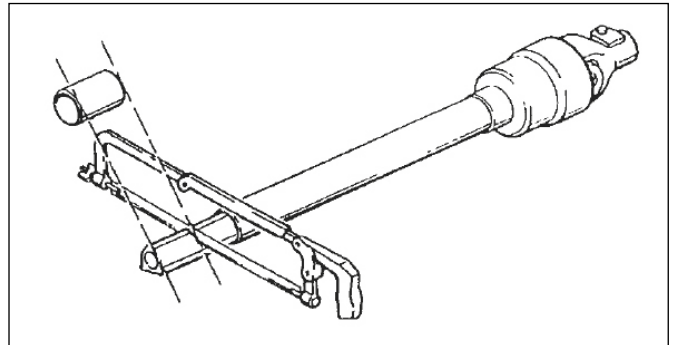

WHEN OPERATING THE PTO SHAFT CHECK THAT THE ENGINE IS OFF. ALWAYS WORK WITH THE PTO SHAFT PROTECTED AND IN GOOD CONDITION. PREVENT THE PTO SHAFT'S TUBE FROM TURNING BY SECURING IT WITH THE CHAIN PROVIDED.



WHEN LOWERING THE SEED DRILL TO THE GROUND, UNPLUG THE TRACTOR'S UNIVERSAL JOINT SHAFT SO THAT THE PTO SHAFT DOES NOT HAVE AN EXCESSIVE INCLINATION (MAX. 35°).



WHEN HOLDING THE TRACTOR UNIVERSAL JOINT SHAFT'S CLUTCH IN, PERFORM IT GENTLY. STARTING SUDDENLY COULD SERIOUSLY DAMAGE THE SEED DRILL.

5.2 ELECTRICAL CONNECTIONS

Table and diagram of the 7-pin connector:

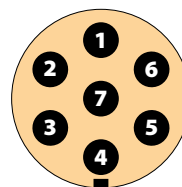

Pin no.	FUNCTION
1	Left turn signal
2	NOT USED
3	Ground
4	Right turn signal
5	Right position light
6	Brake
7	Left position light

5.3 HYDRAULIC CONNECTIONS

To use the machine's hydraulic connections you will need:

- **WHEN FOLDING AND UNFOLDING THE MACHINE:** a double-acting connection.
- **WHEN FOLDING AND UNFOLDING THE TRACK MARKERS:** a double-acting connection.
- If the machine has **HYDRAULIC FAN:** an extra single-acting (connection) and a free return line.

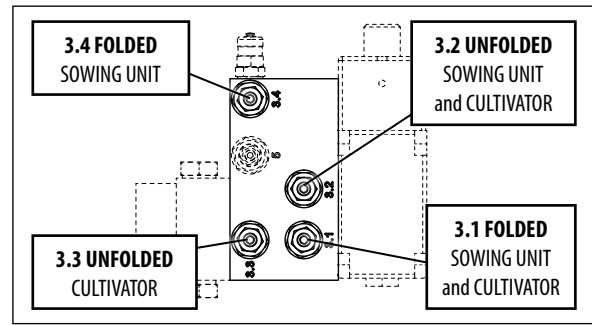

COLOUR OF THE CAP	DESCRIPTION
BLUE	Track marker's hydraulic system.
GREEN	Hydraulic system to fold and unfold the sowing equipment
RED	Service brake's hydraulic system.



FOR THE FREE RETURN LINE CONNECTION USE THE PLUG-ADAPTER PROVIDED.



NEVER STAY UNDER THE TINE COULTER UNIT OR WITHIN ITS OPERATING RANGE



THE FOLDING PARTS OF THE CULTIVATOR AND THE SOWING UNIT HAVE SAFETY CATCHES TO PREVENT THESE MOVING PARTS FROM DROPPING. BEFORE STARTING WORK, REMOVE THE CULTIVATOR SAFETY CATCH AND UNLOCK THE SOWING UNIT BY PULLING/PUSHING THE LEVER. WHEN WORK WITH THE MACHINE HAS ENDED, FOLD THE FOLDING PARTS AND FIT THE CATCHES OF THE CULTIVATOR.

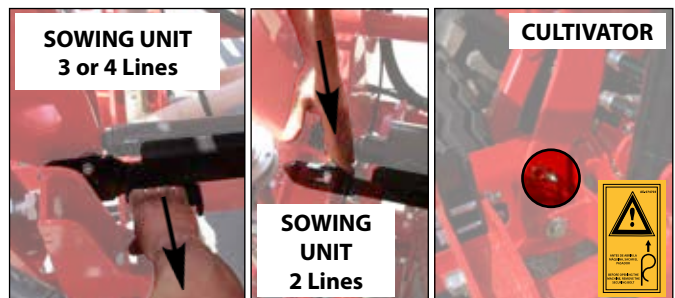

It is best to start with the controller almost closed to prevent excessively fast folding which could damage the seed drill.

5.3.1 HYDRAULIC SYSTEM

FOLDING PARTS

To ensure that the seed drill's folding parts (sowing unit and integrated cultivator) fold and unfold smoothly, there are flow controllers (located in the hydraulic block installed on the right-hand side of the machine chassis), one for each operation, which must be adjusted to the hydraulic output supplied by the tractor.



AUGER CONVEYOR (OPTIONAL)

The hydraulic connectors for the auger conveyor loader are located at the rear of the machine, beside the ladder.



TO AVOID INJURIES OR DAMAGE TO THE MACHINE, LOAD THE AUGER CONVEYOR HOPPER WITH THE MACHINE FULLY UNFOLDED.



MAKE SURE THAT THE ELECTRICAL AND HYDRAULIC CONNECTIONS ARE TIGHT.

To load:

- 1- Unfold the folding parts, remember to remove the safety catches from the folding parts and the cultivator.
- 2- Connect the hydraulic terminals of the auger conveyor loader to the sockets located at the rear of the machine.
- 3- Press the load switch at the front of the machine.
- 4- Pressurize the hydraulic circuit for unfolding the folding parts.

To disconnect the auger conveyor:

- 1- Depressurize the hydraulic circuit.
- 2- Press the load switch at the front of the machine.
- 3- Remove the loader's hydraulic terminals from the sockets.



5.4 TRANSPORT POSITION

To set up the transport position, follow these steps:

- 1- Fold the TRACK MARKERS.



- 2- Raise the machine until the TINE COULTERS are detached from the ground.

- 3- Fold the INTEGRATED CULTIVATOR and put the 2 security bolts that secure the folding parts.



- 4- Fold the 2 FOLDING PARTS of the machine.



- 5- Check that the LADDER to gain access to the hopper and the hopper's folding cover are both folded and secured.



Check that the SIGNAL LAMPS are working properly.



AFTER COUPLING THE SEED DRILL TO THE TRACTOR, CHECK THAT THE SAFETY TRIGGERS ARE CORRECTLY IN TRANSPORT POSITION.



PREVENT THE MOBILE PARTS FROM MOVING.

5.5 LOADING THE SEED DRILL MANUALLY

For access to the hopper, the access ladder should be unfolded.

Pull the trigger (1) to free the folding flight to the ground.

To fold, return the folding flight until the safety trigger is secured.

Remove the tension element (2) of the hopper's folding cover and fold it over to the left using the handle (3).

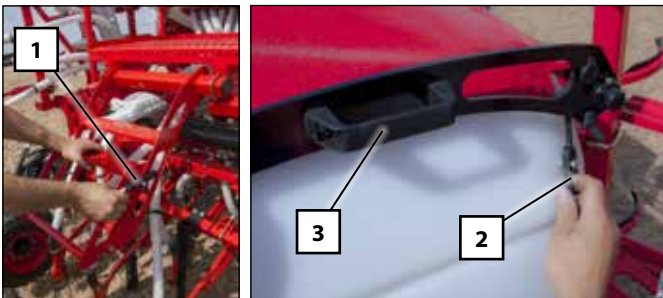

TO LOAD THE HOPPER WITH FEEDING AUGER, PERFORM THE OPERATION WITH THE FOLDING PARTS UNFOLDED.

5.6 THE BUILT-IN SUPPORTING LEGS

The machine has two built-in supporting legs to prevent it from falling back during the uncoupling manoeuvre.

Before starting work with the machine, RAISE THESE SUPPORTS.



WORKING WHILE THE SUPPORTS ARE IN PLACE MAY CAUSE DAMAGES TO THE MACHINE.



BEFORE RAISING THE SUPPORTING LEGS, THE MACHINE MUST BE RAISED TO MAKE THE OPERATION EASIER AND PREVENT THE MACHINE FROM FALLING BACKWARDS.

- 1- Remove the safety ring (1).
- 2- Remove the securing bolt (2).
- 3- Shift the support upwards.
- 4- Align the 2 holes and place the securing bolt (2).
- 5- Place the safety ring again. (1).

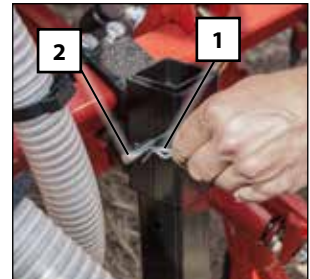

6. DOSAGE

There are two ways of dosing:

- for **REGULAR SEEDS.**
- for **FINE SEEDS** with minimum flow rate.

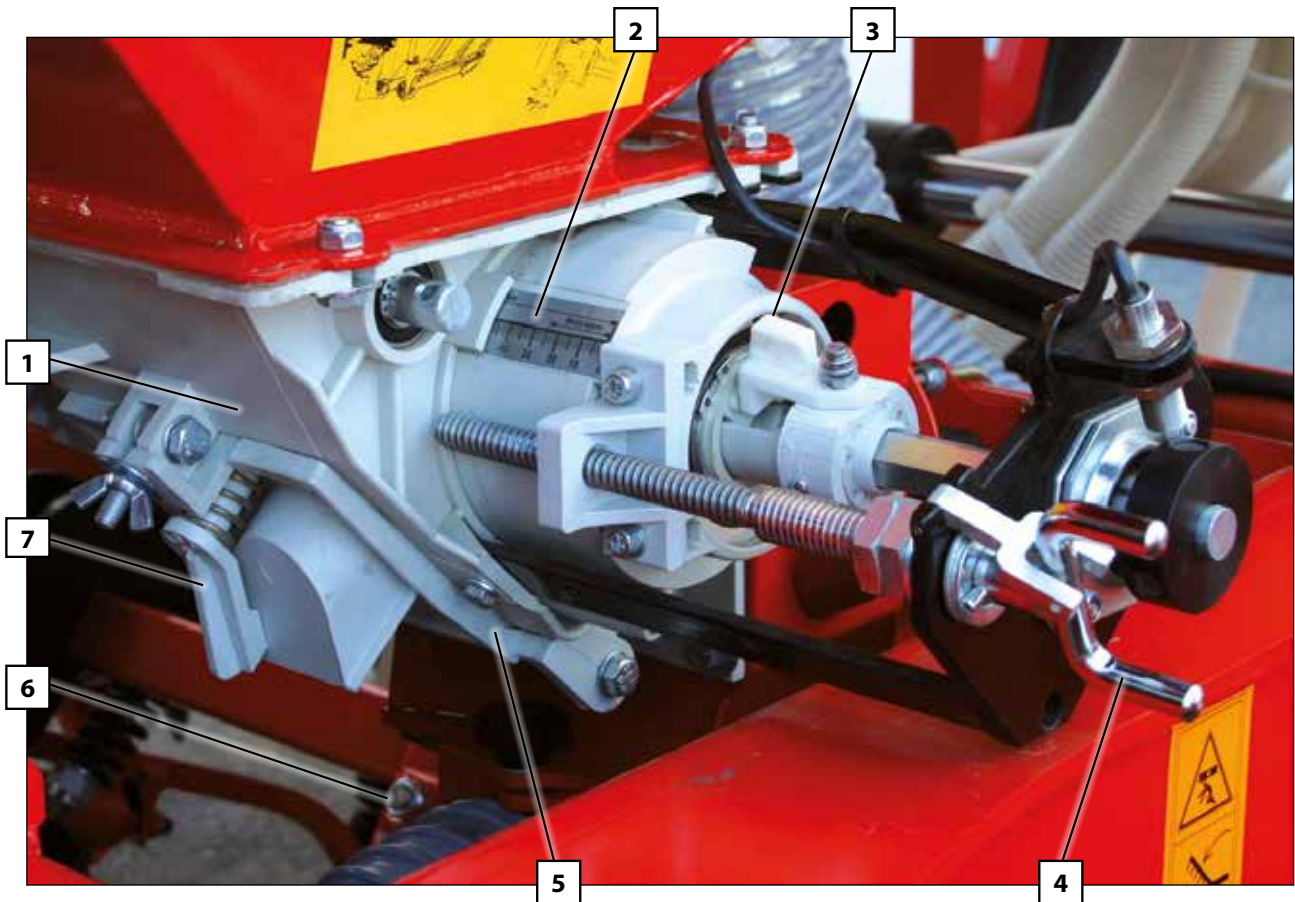

1- Seed distributor.

2- Dosing adjusting scale.

3- **Bolt:**

N = regular seed

F = fine or small seed

4- Spindle.

5- Trap-door to empty the hopper and the seed distributor.

6- Venturi injector sluice.

7- Quick emptying trap-door.

8*- **Clip pin of the air outlet to fan *.**

N = regular seed

F = fine or small seed



WHEN CHANGING THE BOLT'S POSITION (3) IT IS ESSENTIAL THAT THE SPINDLE (4) CAN TURN FREELY AND THE HOPPER IS EMPTY.

8* FAN IN MACHINES UP TO 5 METRES LONG



8* FAN IN MACHINES 6 METRES LONG



6.1 REGULAR SEEDS (position N)

When sowing using REGULAR SEEDS, proceed as following:

- 1- Remove the safety fork (9).
- 2- Keep the bolt (3) in the position as indicated in the figure.
- 3- Turn the spindle (4) to adjust dosing.
- 4- Place the clip pin of the air outlet to fan (8) at position N.

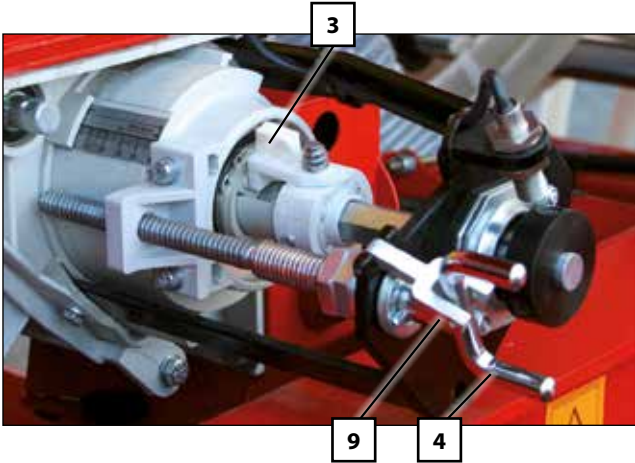

FAN IN MACHINES UP TO 5 METRES LONG



FAN IN MACHINES 6 METRES LONG



- 5- Pinion gear n°10 must be fit into pinion gear n°11.

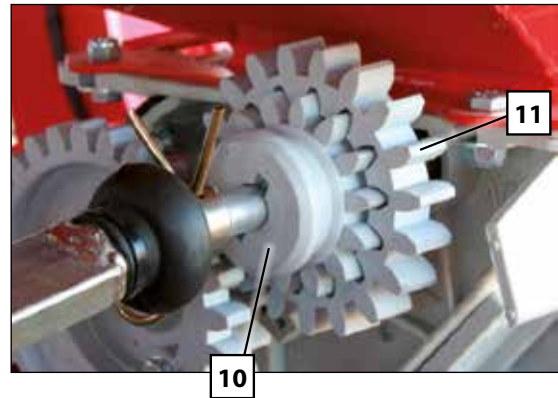

6.2 FINE SEEDS (microdosing – Position F)

When sowing using FINE SEEDS, proceed as following:

- 1- Remove the safety fork (9).
- 2- Turn the spindle (4) to position 0 on the scale (2).
- 3- Turn the bolt (3) until it is inserted into axle slot, like to the picture.

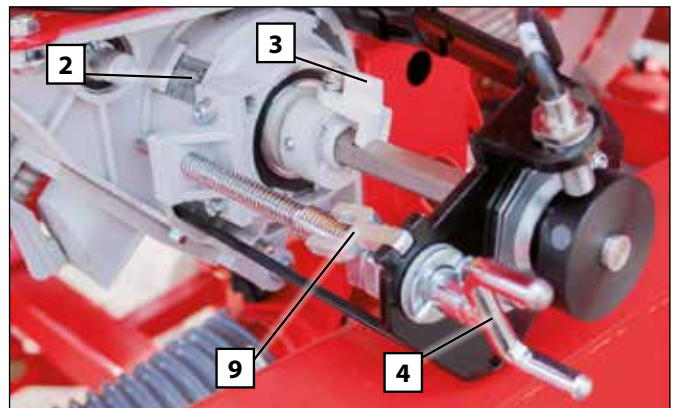

- 4- Place the clip pin of the air outlet to fan (8) at **position F** (fine seed).

FAN FOR MACHINES UP TO 5 METRES LONG.



FAN FOR MACHINES UP TO 6 METRES LONG.

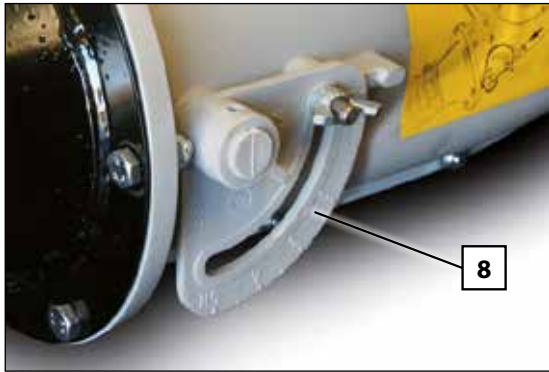

- 5- Turn the spindle (4) to adjust dosing between 0 and 25.
- 6- Pull the pinion gear nº10 until it **is released** from the pinion gear nº11 and fit it into pinion gear nº12.
- 7- Once the seed distributor is set in position F (microdosing), the ELECTRONICAL CONTROLLER needs to be configured (see page 54, working in micro mode).

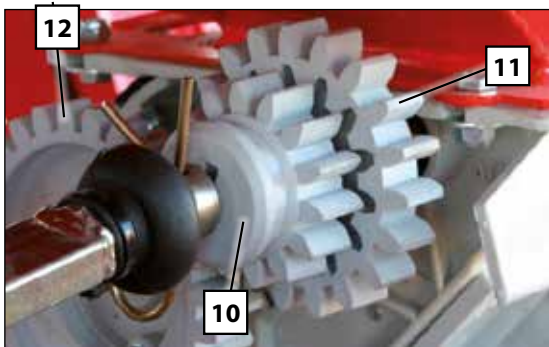

THE AIM OF MICRODOSING IS TO BETTER DISTRIBUTE BOTH FINE AND REGULAR SEEDS IN SMALL NUMBERS.



THE CORRECT VALUE FOR USING MICRODOSING F-SYSTEM IN FINE SEEDS CAN BE FOUND IN THE DOSING TABLES



CHECK THE CLEANING BRUSH IS IN GOOD CONDITION BEFORE BEGINING TO SOW FINE SEEDS.



WHEN MICRODOSING FINE SEEDS, DO NOT EXCEED NUMBER 25 IN ADJUSTING SCALE (2).

6.3 PREVIOUS FLOW TEST



IT IS ESSENTIAL THAT THE MACHINE, THE TRACTOR AND THE UNIVERSAL JOINT SHAFT ARE ALL SWITCHED OFF.

To perform the test, follow these instructions:



- 1- FILL THE HOPPER with seeds.



- 2- COUPLE the machine to the tractor in a SLIGHTLY ELEVATED POSITION (wheels should not be in contact with the ground).
- 3- Open the lower trap-door (1).

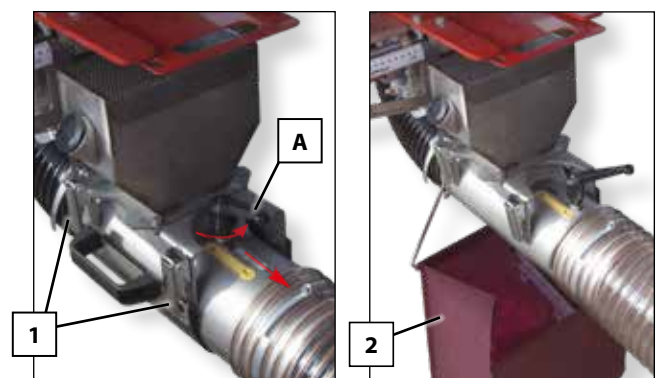

- 4- Turn the handle for unblock him (A) and move it to position "NO" (Test position).
- 5- Place the provided sack (2) or a container under the exit of the venturi injector sluce.

6- See dosing table to set the desired dose. Start with the dosing unit set to low values. If it is necessary to reduce the dose, proceed as follows; close the dosing unit and, at the same time, turn the drive wheel.



7- Next, place the crank in the right wheel of the seed drill.

Turn it clockwise as many times as indicated below depending of the type of machine.

TYPE OF MACHINE	WHEEL 10.0/75-15,3 (turns)	WHEEL 340 / 55-16 (turns)
400	27,4	26,5
450	24,4	23,5
500	22	21,2
600	18,3	17,7
700	15,7	15,1

8- Accurately weigh the collected seeds.

9- At a selected opening, you can obtain the kilograms per hectare distributed by the machine, by MULTIPLYING the weight by 40.



DO NOT TURN THE WHEEL WITH YOUR HANDS AS THE MUD SCRAPER CAN CAUSE INJURIES.



YOU MUST TURN THE WHEEL UNIFORMLY USING THE CRANK AT APPROXIMATELY ONE REVOLUTION PER SECOND.



THE NUMBER OF WHEEL TURNS TO BE PERFORMED DEPENDS ON THE LAND'S CHARACTERISTICS, TYRE MANUFACTURER AND TYRE PRESSURE. THEREFORE IT IS HIGHLY RECOMMENDED TO PERFORM A FIELD TEST AS DESCRIBED IN SECTION **6.4 - TEST TO DETERMINE THE NUMBER OF WHEEL TURNS.**



WHEN YOU END THE TEST, CLOSE THE COVER OF VENTURI INJECTOR, MOVE HANDLE IN POSITION "OK" AND LOCK IT.



IF SEEDS SHOW EXCESS TREATMENT POWDER, FLOW CAN BE REDUCED, CONSEQUENTLY A SECOND CONTROL IS RECOMMENDED AFTER SOWING APPROXIMATELY THREE HOPPERS.



6.4 COMPLEMENTARY CHECKING TESTS

6.4.1 TEST TO DETERMINE THE NUMBER OF WHEEL TURNS



IF DIFFERENCES EXIST BETWEEN THE TEST AND THE ACTUAL DOSE DISTRIBUTION (DUE TO A VERY UNEVEN OR LIGHT SOIL, LOW PRESSURISED TYRES, ETC.), AN EXPERIMENTAL TEST CAN BE PERFORMED.

1- First of all, the distance (in metres) as shown in the table below should be marked on the field's ground using a tape measure.

WORKING WIDTH / ROWS	METRES TO COVER
400	62,5
450	55,6
500	50,0
600	41,7
700	35,7



2- By means of a mark made previously on the tyre, count the number of turns performed in the covered distance. A good place whereby which to count could be the wheel's mud scraper.



3- Next, the seed drill in working position should cover that distance.

By following these steps we can obtain the actual number of turns performed in the seed dosing test.

By performing the test using this obtained number of turns, we know the actual kilograms per hectare that will be distributed by the machine.

6.4.2 SEED DOSING ADJUSTMENTS

When using high quality certified seeds it is not enough to know the weight in kilograms distributed by the machine, as the final result of the harvest will depend on the number of plants which eventually ripen.

Every plant requires a certain amount of land from which nutrients will be absorbed. Therefore, both a low or an excessive plant density can be detrimental. To determine how many kilograms per hectare are to be sown, you should know the number of plants per square metre that are going to be planted.

As a guidance, the recommended number of plants per square metre when sowing wheat or barley in unirrigated land can be found in following table:

AUTUMN	SPRING
Premature sowing, 200 plants per m ²	Premature sowing, 310 plants per m ²
Late sowing: 265 plants per m ²	Late sowing: 445 plants per m ²

Please note that in spring there is less tillering so more seeds should be sown.



MAQUINARIA AGRÍCOLA SOLÀ, S.L., RECOMMENDS THAT THE FARMER SEEKS PROFESSIONAL ADVICE ABOUT THIS SUBJECT FROM A TECHNICAL SOWING CENTRE.



SEED DOSING SHOULD BE ADJUSTED TO EACH TERRAIN, DEPENDING ON THE: TEXTURE, FERTILIZING LEVEL, PLUVIOMETER RESULTS AND SOWING SEASON, GRAIN QUALITY, GERMINATING AND TILLERING POWER, ETC.

It should be taken into account that a seed's germinating power is variable and dependant on multiple factors. It can be experimentally calculated to be between 70% and 80%, which is practically equivalent to multiplying the number of grains to be sown by 1.43 or 1.25 respectively.

Next, we describe a practical method to determine the number of kilos per hectare to be distributed once we know how many plants per square metre we want to obtain.

- 1- Insert the "seed counter" into the seed sack to fill it.
- 2- When taking the "seed counter" out, wipe the seed counter with your hand to make sure that there is only one grain per slot (100 grains in total).

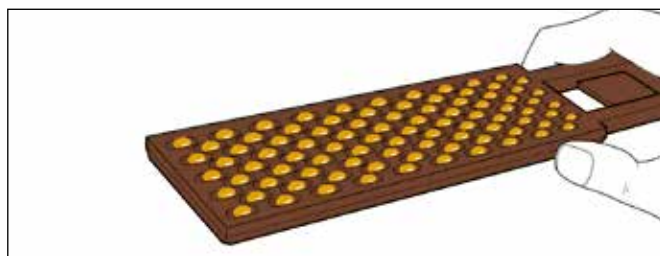

- 3- Do the same 10 more times to obtain 1000 grains.
- 4- Weigh these 1000 grains with the precision scales. We call the result the OPERATIVE WEIGHT (g). Once we know how many seeds per square metre we are going to sow, we should adjust the following kilograms per hectare in the dosing control:

$$\text{KILOGRAMS PER HECTARE} = (\text{GRAINS PER M}^2 \times \text{OPERATIVE WEIGHT}) / 100$$

7- ADJUSTING SEED PLANTING DEPTH



SEED DRILL SHOULD ALWAYS WORK HORIZONTALLY, WITH BOTH THE REAR AND FRONTAL TINE COULTERS EQUALLY PENETRATING THE LAND.



VERY IMPORTANT: THE TRACTOR'S CONTROLLER THAT MOVES THE FOLDING PARTS' CYLINDER MUST BE IN FLOTATION MODE, TO BETTER ADAPT TO THE GROUND.

7.1 ADJUSTING RATCHETS AND SPINDLES

There are 2 central spindles for the sowing unit (A) and 2 on the depth-control side wheels. All have a scale to show their position.



For models with rear cultivator, this is adjusted by 2 spindles (B).



ADJUST BOTH SIDES EQUALLY

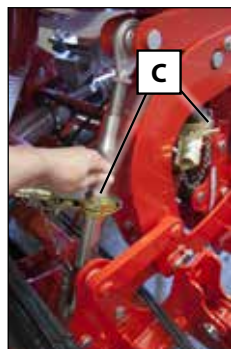
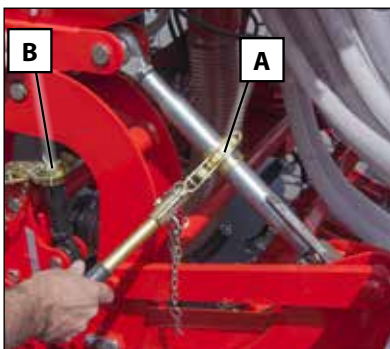

After adjustments, block the control lever of the ratchet in the position indicated according to the illustrations. Block his position with the securing bolt.v

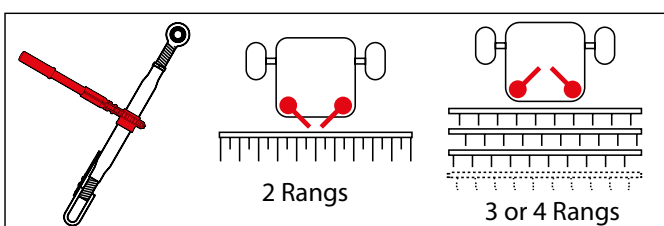

WHEN SOWING ON TILLED OR NON-COMPACT GROUND, TAKE THE PRECAUTION OF SELECTING ONE OR TWO POINTS LOWER IN THE ADJUSTING SCALE ON THE SIDE WHEELS IN ORDER TO AVOID SINKING INTO THE GROUND.

To adjust the side wheels, use the crank provided.

Steps to follow for the regulation of equipment:

- 1- To adjust the side wheels, use the crank provided.
- 2- Unlock using the securing knob (2).
- 3- Turn the crank right or left as required (1).
- 4- Use the scale to reach the suitable height.

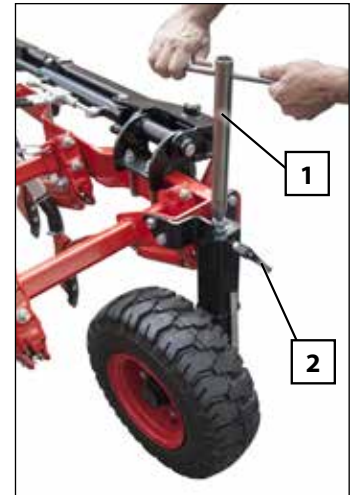

7.2 INCLINATION OF THE FOLDING PARTS

At the connection point between the folding parts and the central chassis, there are adjustable stops (two each side) which allow the inclination angle of the folding parts to change.



- 1- Loosen the 2 securing nuts.
- 2- Remove the 2 screws.
- 3- Place the stop in the desired position.
- 4- Insert the 2 screws and tighten them using the 2 securing nuts.



DURING NORMAL SOWING CONDITIONS, THE FOLDING PARTS SHOULD BE SLIGHTLY LOWER THAN USUAL TO ADAPT TO TERRAIN IRREGULARITIES. IN VERY TILLED OR LOOSE LAND, AS WELL AS IN SOILS WITH HIGH HUMIDITY, THE FOLDING PARTS SHOULD BE LEVELLED TO STAY HORIZONTAL.

7.3 TRACK ERASERS

To eradicate the wheel marks of the tractor and the sowing unit itself, there are some wheel mark eradicator arms whose height must be adjusted. To do so:

- 1- Remove the pins and the bolts (3).
- 2- Move the track eraser to the desired position.
- 3- Insert the two bolts and secure them with the pins (3)

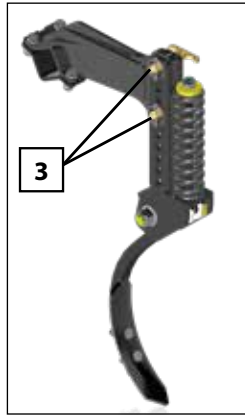

7.4 LEVELLER (OPTIONAL)

The work of the leveller is essential to obtain a uniform seed planting depth.

There are two leveller models; FLAT or TINES.

The leveller can be adjusted by operating the spindles (4), which modify height and pressure of leveller's three sections.



It is recommended to use the FLAT leveller on dry fields and the TINE leveller on damp fields.



EARTH DRAGGED BY THE LEVELLER SHOULD NOT PROTRUDE OVER THE PLATE.



WHEN USING PNEUMATIC MACHINES, THE AIR PRESSURE ALONG WITH ABSENCE OF STOPS IN THE TINE COULTERS' SOWING SHOES WILL CAUSE A GREATER PLANTING DEPTH THAN ACHIEVED USING CONVENTIONAL MACHINES. AFTER SOME MINUTES WORKING, CHECK THAT THE PLANTING DEPTH IS ADEQUATE.

7.5 SEEDING ARM

There are several types of row; each type is designed for optimal sowing depending on the type of land to be sown.

7.5.1 TINE COULTER

Fixed tine coulters:

These tine coulters have a non-adjustable depth, but their pressure can be adjusted by using a nut placed in the lower part of the spring (A). Sowing depth will be determined by the adjustable central ratchets.

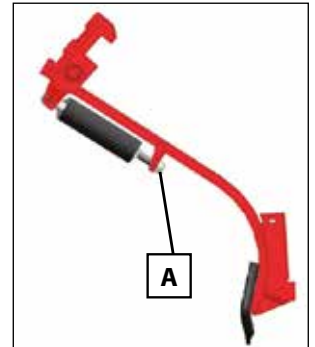

Adjustable tine coulters:

These tine coulters are aligned with both the tractor's and the seed drill's wheels. They are adjustable levels of depth which allow the tine coulters to be lowered:

- 1- Turn the nut with a wrench to lose the screw (B).
- 2- Turn the screw stop to control depth (B).
- 3- Tighten the nut to secure the position (B).

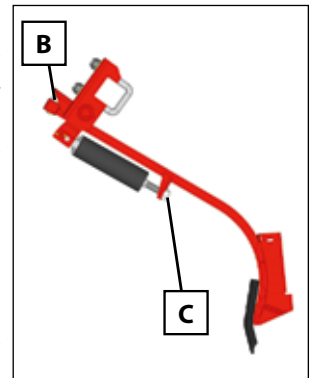

The row pressure is adjusted by means of the nut (C).

7.5.2 PT

Fixed tine coulters:

These tine coulters have a non-adjustable depth, but their pressure can be adjusted by using a nut placed in the lower part of the spring (D). Sowing depth will be determined by the adjustable central ratchets.

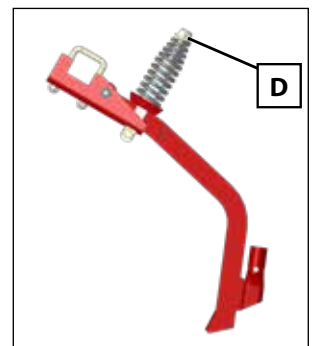

Adjustable tine coulters:

These tine coulters are aligned with both the tractor's and the seed drill's wheels. They are adjustable levels of depth which allow the tine coulters to be lowered:

- 1- Turn the nut with a wrench to lose the screw (B).
- 2- Turn the screw stop to control depth (B).
- 3- Tighten the nut to secure the position (B).

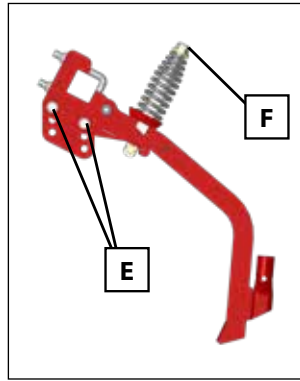

The row pressure is adjusted by means of the nut (F).

7.5.3 DISCS

Disc coulters:

The pressure on the soil can be adjusted using three spindles, one for each folding part and another for the centre of the machine.

Turn the spindle clockwise to increase the sowing depth.
Turn the spindle anticlockwise to decrease the sowing depth.
There is an optional equipment which consists of a wheel to adjust the sowing depth.

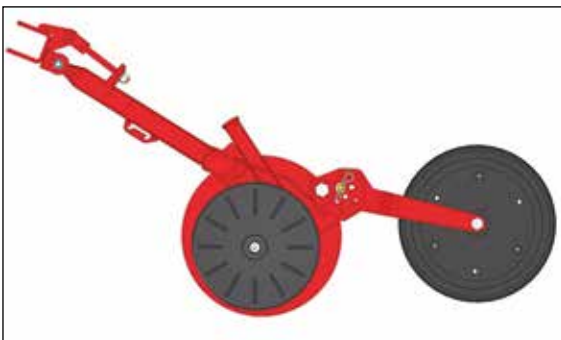

7.5.4 SUFFOLK COULTERS

Suffolk coulters:

The pressure on the soil can be adjusted using three spindles, one for each folding part and another for the centre of the machine.

Turn the spindle clockwise to increase the sowing depth.
Turn the spindle anticlockwise to decrease the sowing depth.



7.5.5 DOUBLE DISC

Double disc seeding arms:

The pressure on the floor can be adjusted using the lever (1), and can be adjusted in two positions.

To adjust the depth of each arm independently, operate the piston (2)

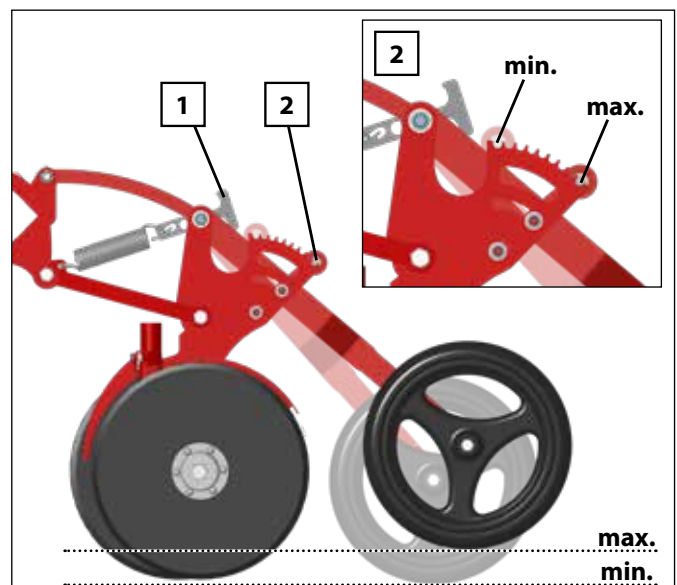

7.6 HARROW

Some adjustments can be performed on the harrow so that it can adapt to all types of ground:

HEIGHT ADJUSTMENT, by operating the lower nut (1).
PRESSURE ADJUSTMENT, by using the spindle's upper nut (2).
INCLINATION OF THE TINES, by operating the screw (3) which holds the tines' chassis.

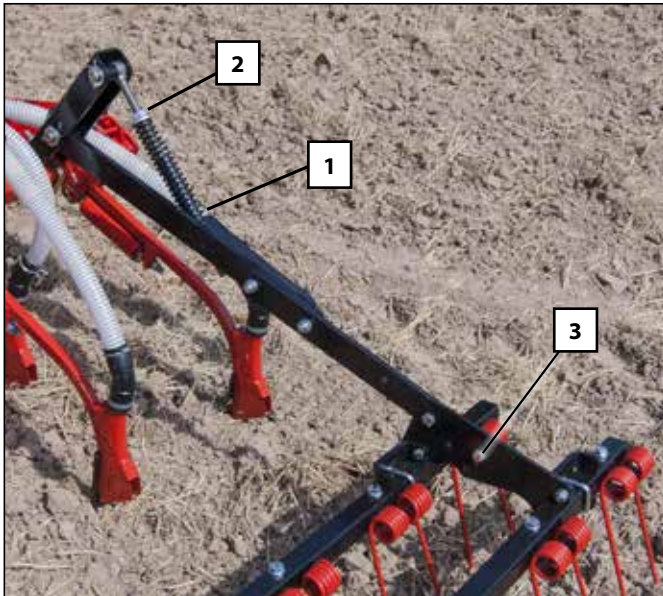

NEVER STAND UNDER THE TRACK DISCS OR WITHIN THEIR OPERATIONAL AREA.



IT IS ESSENTIAL TO FOLD THE TRACK MARKERS BEFORE FOLDING THE MACHINE FOR TRANSIT.

7.7.1 ADJUSTING TRACK MARKER'S LENGTH

To calculate the horizontal spacing between track discs and the last lateral tine coulters, use following formula:

$$B = \frac{A \times (\text{number of tine coulters} + 1) - C}{2}$$

A= distance between tine coulters

B= horizontal distance between track disc and the the last lateral tine coulters.

C= track width of the tractor.

7.7 HYDRAULIC TRACK MARKERS

Track discs can be orientated to achieve the correct penetration angle and their supporters are extensible in order to be correctly adjusted.

LENGTH (horizontal spacing between disk and external tine coulters).

ORIENTATION (attack angle).



PERFORM THE CALCULATION USING MEASUREMENTS IN CENTIMETRES.

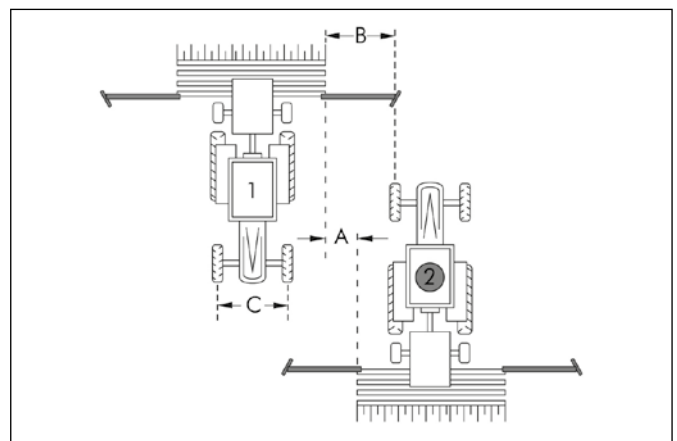

To adjust the distance of the track disc, proceed as following:

1- Loosen the 2 nuts (1).

2- Place track disc at the distance **B** previously calculated.



HIGH PRESSURE OIL MAY ESCAPE, PASS THROUGH THE SKIN AND INGRESS INTO THE BODY, CAUSING SERIOUS INJURIES. KEEP HYDRAULIC HOSE LINES IN GOOD CONDITION.



B= DISTANCE BETWEEN THE TRACK DISC AND THE LAST LATERAL TINE COULTER.

3- Tight the 2 nuts (1) after finishing these operations.

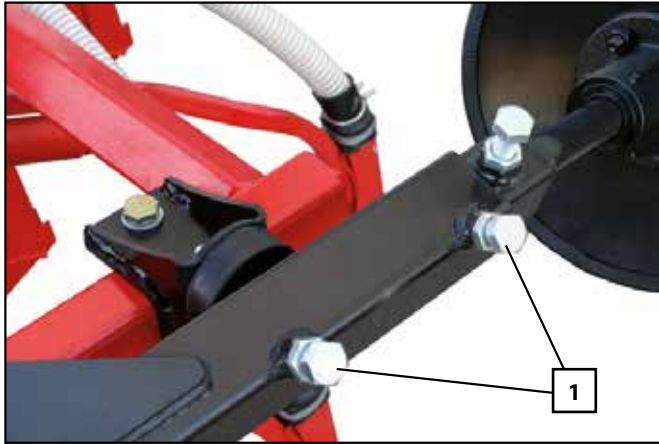

7.7.2 ADJUSTING TRACK MARKER'S INCLINATION

To adjust the orientation of the track discs, proceed as following:

- 1-** Loosen the nut (2)
- 2-** Adjust track disc's inclination so the disc has the desirable impact on the ground.
- 3-** Tight the nut (2) after finishing these operations.

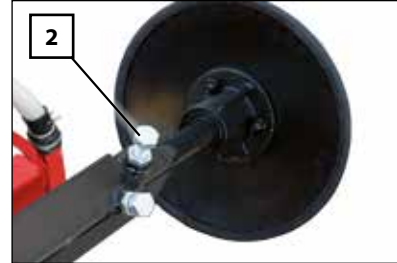

IT IS NOT RECOMMENDED TO INCLINE THE TRACK DISCS TOO MUCH THUS PREVENTING SERIOUS DAMAGE TO THE MACHINE.

8. TYPES OF DISTRIBUTION

8.1 SEED DISTRIBUTION BY MECHANICAL FAN



TO ENSURE THAT SEEDS ARE SUPPLIED TO THE TINE COULTERS' SOWING SHOES, IT IS ESSENTIAL THAT THE FAN SPEED IS BETWEEN 4200 AND 4500 RPM. FOR THIS PURPOSE, THE PTO SHAFT MUST BE PLUGGED INTO THE 1000 RPM VENT.



IF THE TURNING SPEED IS LOWER THEN SOME SEEDS ARE LIKELY TO REMAIN IN THE SEED HOSES.



BEFORE THE WHEEL CONTROLLING THE DISTRIBUTOR'S TRANSMISSION STARTS TURNING, PLEASE ENSURE THAT THE FAN'S TURNING SPEED IS BETWEEN 4200 AND 4500. WHEN RAISING THE MACHINE, NEVER DECREASE THE FAN'S TURNING SPEED UNTIL THE WHEEL IS DETACHED FROM THE GROUND.



PLEASE NOTE THAT IF YOU WORK WITH THE MACHINE WHILE THE FAN IS OFF, SEEDS WILL BLOCK THE COLLECTING PIPE OF THE VENTURI INJECTOR SLUICE. IN CASE THIS HAPPENS, THE COLLECTOR SHOULD BE TAKEN OUT AND EMPTIED BEFORE USING THE SEED DRILL AGAIN.



IF THE FAN'S TURNING SPEED IS ABOVE OR BELOW 4200 AND 4500 RPM, THEN TURNING THE WHEEL THAT CONTROLS THE DISTRIBUTOR'S TRANSMISSION CAN CAUSE A BLOCKAGE INSIDE THE SEED HOSES.

8.2 SEED DISTRIBUTION BY HYDRAULIC FAN

CONNECTIONS

Connect the fan's small hydraulic hose line to a pressurised tractor control unit. The fan's 1/2" hydraulic hose line should be connected to a depressurised return tractor control unit.



IN THE RETURN LINE THE PRESSURE MUST BE A MAXIMUM OF 1,5 BAR. A HIGHER PRESSURE CAN CAUSE DAMAGE TO THE TRACTOR'S MOTOR.

ADJUSTMENT

The fan's rpm is adjusted by regulating the tractor control unit.

The fan's turning speed must be adjusted between 4200 rpm and to 4500 rpm as shown in table above.



IF OIL IS OVERHEATED DUE TO AN EXCESSIVE FLOW OR DUE TO LOW OIL SUPPLY, THEN AN ADDITIONAL OIL TANK WILL BE REQUIRED.



IF THE FLOW OF THE TRACTOR'S HYDRAULIC PUMP IS NOT HIGH ENOUGH IT WILL NOT BE ABLE TO POWER THE FAN'S MOTOR OR ACTIVATE THE OTHER ELEMENTS REQUIRED. IN THIS CASE AUXILIARY EQUIPMENT CONSISTING OF A HYDRAULIC PUMP FITTED ON THE TRACTOR'S UNIVERSAL JOINT SHAFT THAT DRIVES THE FAN'S HYDRAULIC MOTOR AS WELL AS A REFRIGERATED OIL TANK WILL BE REQUIRED.

MACHINE TYPE	HYDRAULIC MOTOR		OIL SUPPLY		
	CUBIC CAPACITY (CM ³)	SPEED (RPM)	MINIMUM OUPUT PRESSURE (BARES)	MAXIMUM RETURN PRESSURE (BARES)	OIL FLOW (L/MÍN)
400 / 450	8	4.200	130	1,5	36
500 / 600 / 700	8	4.500	160	1,5	40

9. ELECTRICAL CONTROLLER

9.1 FRONT PANEL DESCRIPTION

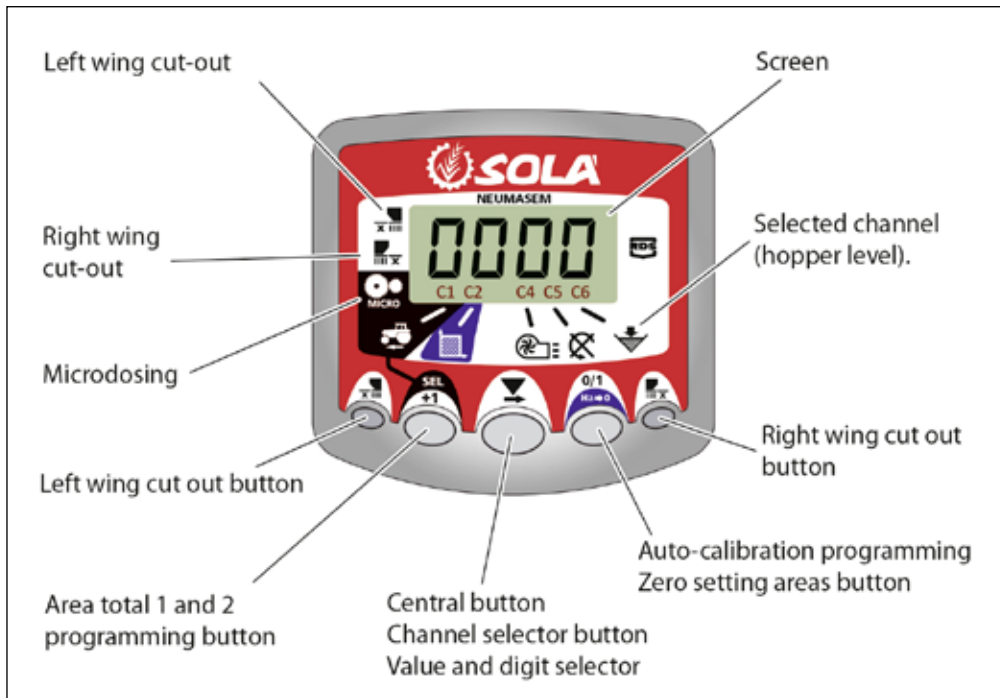

The monitor provided comes programmed especially for your model of seed drill. The user will only need to observe the displayed values and no extra programming is required.

The monitor shows 6 different channels or readings, as well as 3 different arrows showing the states.

C1 shows forward speed in m/ sec.

C2 shows two different hectares (for example on partial and one total hectare).

C3 not in use.

C4 shows the fan's rpm.

C5 shows the turning speed of the distributor's axle's in rpm.

C6 shows if the hopper's seed level is too low.

By default the forward movement speed is displayed on the monitor. When some abnormal readings are shown, the screen will display "Alarm" intermitently, the alarm will sound and the corresponding malfunction channel will be activated. The alarm will not stop until the malfunction is fixed.

To display a desired reading, press the central button and scroll to the required channel. After 10 seconds, the reading will change back to C1 again.

Selecting speed channel (C1)

- 1- Press to switch to mode 1. While holding the button, press the central button to modify the digit.
- 2- Hold the central button for some seconds to modify the flickering digit.
- 3- When the buttons are released, the monitor will return to its normal state.



PLEASE NOTE: THE IMPULSE NUMBER AUTO-CALIBRATION MODE IS MORE ACCURATE AND A FIELD TEST PERFORMANCE IS REQUIRED.

9.2 FORWARD SPEED – C1

Select a channel by using the central button. The alarm is activated when the speed is under 2.6 km/h and can be turned off using programming mode 2.

Calibrating the speed sensor

Theoretical calibration is achieved by entering a calibration factor in programming mode 2, as indicated in the following table.

MODEL	400	450	500	600	700
CALIBRATION FACTOR (RUEDA 10.0/75-15,3)	1,752	1,518	1,402	1,215	1,072
CALIBRATION FACTOR (RUEDA 340 / 55-16)	1,815	1,573	1,452	1,259	1,111

Auto-calibrating the speed sensor

- 1- Mark 100 metres.
- 2- Select channel 1 (speed).
- 3- Press and hold it while pressing . The screen will display "Auto". Release it.
- 4- Cover the 100 marked metres. The monitor will count the sensor's impulses.
- 5- After finishing, press again. By doing this, the monitor retains the impulse number in the memory.

9.3 TOTAL AREA / SEED DRILL WIDTH – C2

Two independent total areas can be marked.

Displaying the total area

- 1- Select channel 2.
- 2- Press  to display total areas 1 and 2 on the screen. First, "tot. 1" will be displayed and immediately afterwards the value in Ha will be shown.

Setting to zero the total areas

- 1- Select channel 2.
- 2- Press  to display.
- 3- Press and hold  for more than 5 seconds.

Programming the working width

- 1- Select channel 2 of the area.
- 2- Press and hold  for more than 5 seconds until the width value is displayed and, without releasing it, press the central button to modify the flickering digit.
- 3- Press and hold the flickering digit for more than 5 seconds to modify its value.
- 4- Release all buttons to return to the normal state.

Working in micro mode

When working with the distributor in the micro-dosing mode (for small hoppers and minimal doses), press and hold  button for more than 3 seconds until the arrow indicating the micro mode is displayed. In this situation, the monitor will keep the speed and actual real working area.

Press and hold  for more than 5 seconds until the indicating arrow disappears to resume normal position.

9.4 CONTROL PANEL WITH MARKER PATHS (OPTIONAL)

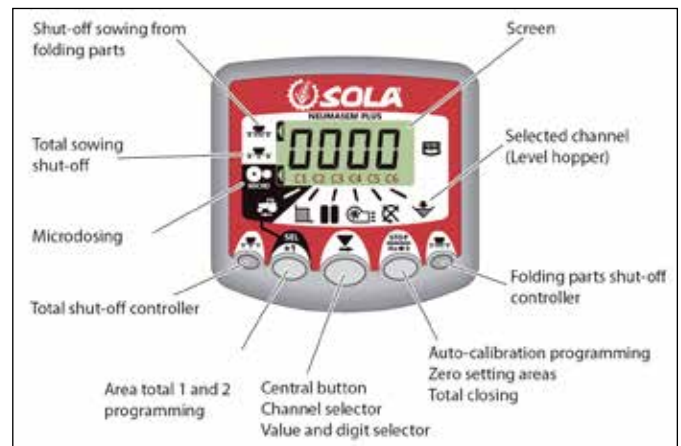

The monitor provided comes programmed especially for your model of seed drill. The user will only need to observe the displayed values and no extra programming is required.

The monitor shows 6 different channels or readings, as well as 3 different arrows showing the states.

- C1** shows forward speed in m/sec.
- C2** shows two different hectares (for example on partial and one total hectare).
- C3** tramlining.
- C4** shows the fan's rpm.
- C5** shows the turning speed of the distributor's axle's in rpm.
- C6** shows if the hopper's seed level is too low.

9.4.1 TRAMLINING - C3

The displays defaults to the  channels after 10 seconds (unless the Area Total was selected).

There are five systems of tramlining - symmetric, asymmetric left, asymmetric right, 10 bout and 18 bout. The tramline bout is programmable from 1 to 15 in symmetric, asymmetric left and asymmetric right sequences.

Selection of asymmetric tramlining is denoted by a decimal point on the display between the current bout number on the left and the tramline bout number on the right. Left or right asymmetric tramlining is selected in the programming mode.

Manually advance the bout number

Press  to advance the current bout number by 1.

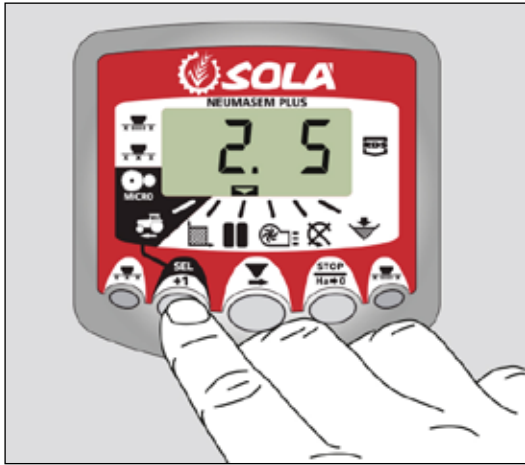

Hold the bout number

Press  to "hold" the current bout when the drill goes out of work.
The display will flash 'STOP'.

Press  againsts to resume the normal bout sequence.



Symmetric Tramlining Sequence

2+2 seed spouts are closed during the tramline bout only. The instrument will beep once the beginning of the tramline bout, and the display will continue flashing for the duration of the bout.

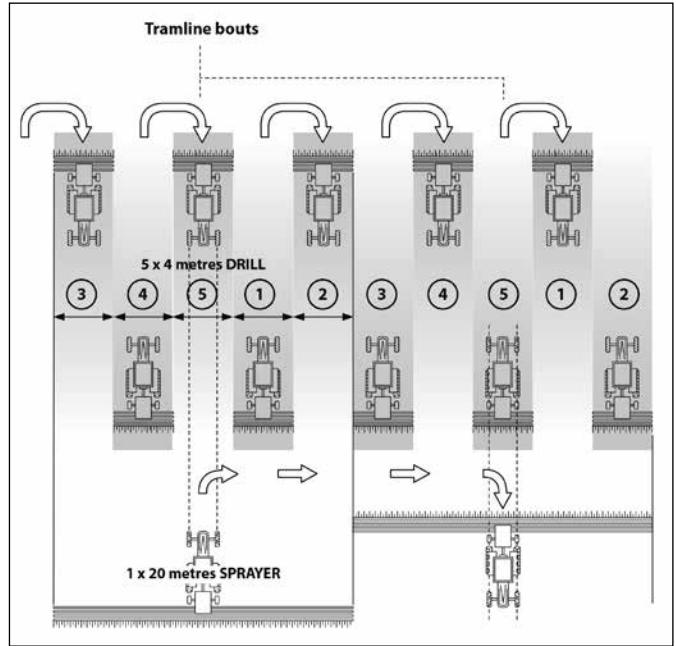

Asymmetric Left Tramlining Sequence

Two seed spouts are closed on the left hand side of the drill on the tramline bouts. The instrument will beep once the beginning of each tramline bout, and the display will continue flashing for the duration of the bout.

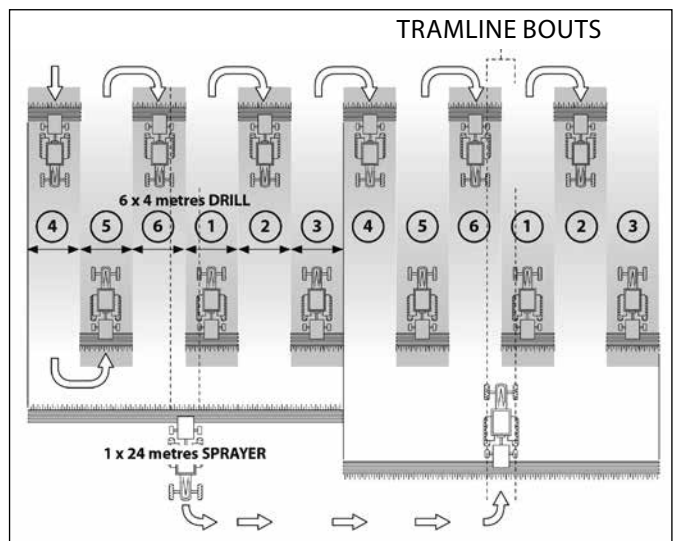

Asymmetric Right Tramlining Sequence

Two seed spouts are closed on the right hand side of the drill on the tramline bouts. The instrument will beep once the beginning of each tramline bout, and the display will continue flashing for the duration of the bout.

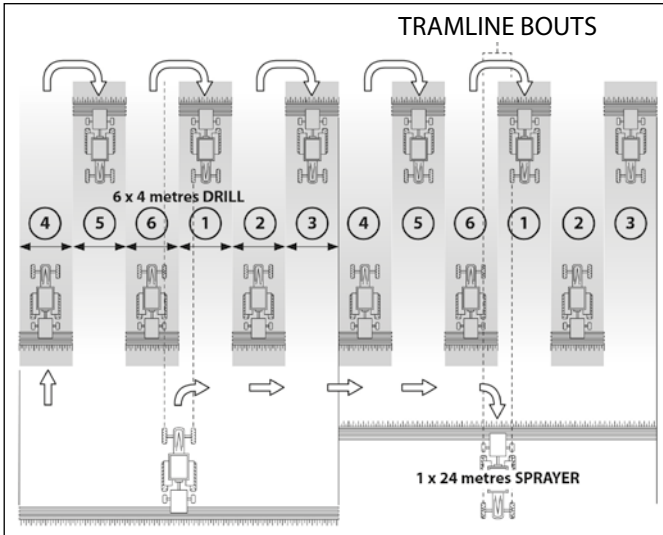

10 Bout Tramlining Sequence

For use with 4 metre drill/10 metre sprayer, or 8 metre drill/20 metre sprayer combinations. (2 x 2 left hand seed spouts are closed on bouts 4 and 7, and 2 x 2 right hand seed spouts closed on bouts 2 and 9). Starting on bout 1 requires turning RIGHT at the end of the first bout.



NOTE TO TURN LEFT AT THE END OF THE FIRST BOUT, ADVANCE THE BOUT NUMBER TO 6 BEFORE COMMENCING DRILLING.

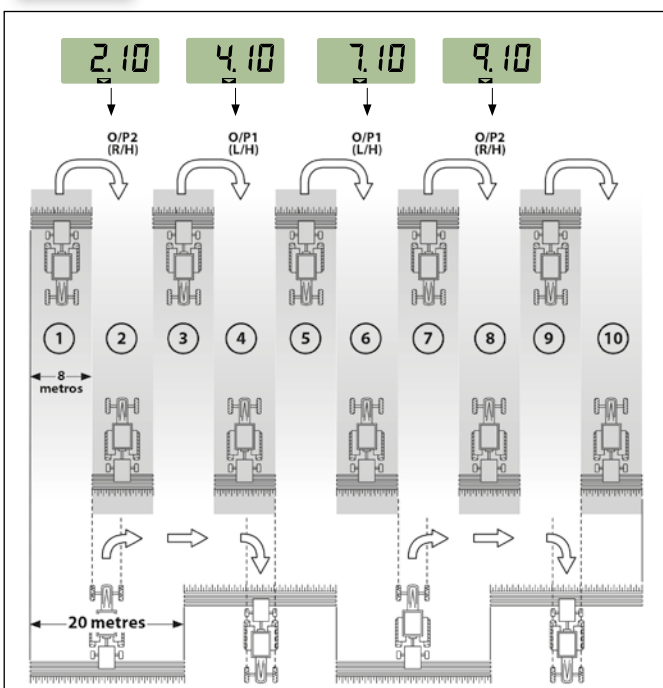

18 Bout Tramlining Sequence

For use with 4 metre drill and an 18 metre sprayer. (2 x 2 left hand seed spouts are closed on bouts 3 and 16, and 2 x 2 right hand seed spouts closed on bouts 7 and 12). Starting on bout 1 requires turning RIGHT at the end of the first bout.





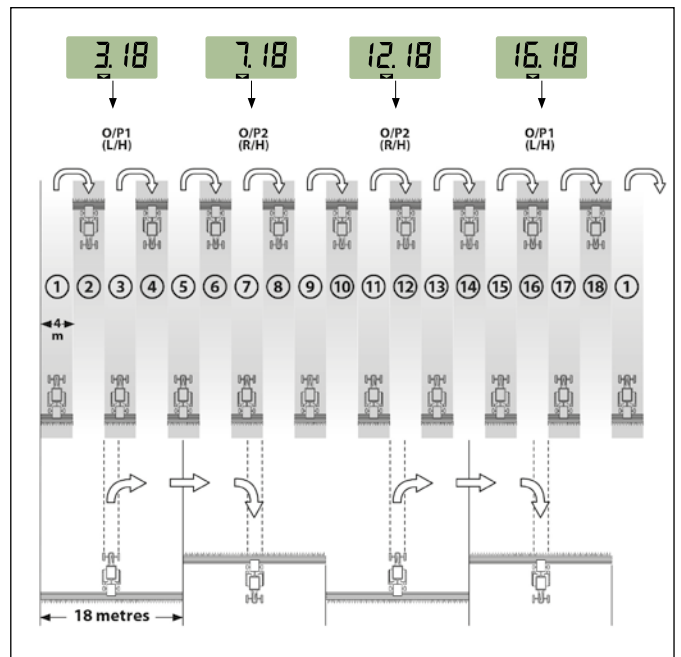

NOTE: TO TURN LEFT AT THE END OF THE FIRST BOUT, ADVANCE THE BOUT NUMBER TO 10 BEFORE COMMENCING DRILLING.

The instrument will beep once the beginning of each tramline bout and the display will flash for the duration of the tramline bout.





Selecting the Tramline Sequence

- 1- Select the  channel.
- 2- Hold  to enter programme mode 1. After 5 seconds the first two digits flash, indicating the tramline sequence currently set:
 'SY' = Symmetric
 'AL' = Asymmetric Left
 'Ar' = Asymmetric Right
 'AS' = Special Asymmetric sequence e.g. 10 bout and 18 bout.
- 3- Continue holding the  button and press and HOLD the  button to select the required sequence.



Setting the Tramline Bout

- 1- PRESS and RELEASE the  button to toggle between the tramline sequence and tramline bout number display. The 3rd and 4th digits flash indicating the tramline bout number currently set.
- 2- PRESS and RELEASE the  button to cycle the tramline bout from 1 to 15.



9.5 FAN RPM / FAN ALARMS – C4



To display the fan's speed in rpm

Select channel 4 using the central button .

Fan alarms

The fan's minimum turning speed can be programmed. Under 2 Km/h these alarms will deactivate.





Fan's minimum speed

- 1- Select channel 4.
- 2- Press and hold  button for more than 5 seconds.
- 3- Hold it and press the  to change value and digits as explained in former cases. Default speed is 3800 rpm.
- 4- Release all buttons to resume the normal position.

Selecting the fan's number of impulses per revolution (default value is set to 2).

PLEASE NOTE

FAN'S NUMBER OF IMPULSES PER REVOLUTION SHOULD ALWAYS BE 2. ONLY USE THIS PROGRAMMING MODE IN CASE OF MALFUNCTION.

- 1- TO SELECT PROGRAMMING MODE 2, PRESS  (MONITOR NEUMASEM) OR  (MONITOR NEUMASEM PLUS) BUTTON WHILE SWITCHING ON THE SCREEN USING REAR SWITCH.
- 2- PRESS  (MONITOR NEUMASEM) OR  (MONITOR NEUMASEM PLUS) TO CHANGE THE CHANNEL AND SELECT CHANNEL 4 (FAN).
- 3- PRESS AND HOLD THE  TO MODIFY THE FLICKERING DIGIT (IT SHOULD ALWAYS BE 2).
- 4- RELEASE THE BUTTON TO CHANGE BACK TO NORMAL POSITION.

9.6 SEED SHAFT RPM – C5

Select channel 5 using the central button .

40 seconds after the seed shaft stops turning, an alarm beeps 5 times consecutively. If it remains still, this alarm will repeat every 30 seconds.

To turn off the beeping, switch off the screen and switch it on again. This alarm will deactivate under 2 Km/h.



The seed shaft's alarm can be deactivated by pressing the

button  for more than 5 seconds on the selected channel. The screen will display "Off". In this situation the alarm will not be activated even if the screen is switched off and on again.

9.7 HOPPER LOW LEVEL ALARM – C6

When the seed level is below the sensor, an alarm is activated and beeps 5 times consecutively. In this case the screen will display «ALA».

Activate and deactivate hopper level alarm

- 1- Select channel 6 using the central button .
- 2- Press and hold  button and...

3- Press the central button to select "0" (alarm is off) or "1" (alarm is on).

4- Release the buttons to change back to the normal position.

9.8 TOTAL SOWING SHUT-OFF (OPTIONAL)



NEUMASEM electronical controller

Press  to **lock** the seed's exit. The screen will display the flickering text «CORT».

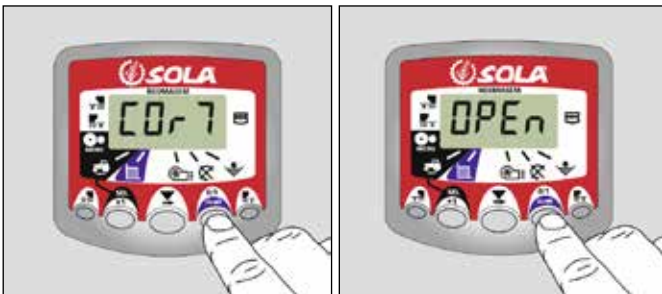
Press  again to **unlock** the seed's exit and return to a normal working position. The screen will display the flickering text «OPEN».



NEUMASEM PLUS electronical controller

Press  to **lock** the seed's exit. The screen will display the indicating arrow and the text "CORT" will be displayed every 2 seconds «CORT». Press  again to **unlock** the seed's exit and return to a normal working position. The screen will display the flickering text «OPEN».



9.9 SHUT-OFF SOWING FROM FOLDING PARTS (OPTIONAL)



NEUMASEM electronical controller

Press  to **lock** the seed's exit from the arms on the folding parts (exits on the left and right sides of the folding parts will lock). The screen will display the indicating arrow.

Press  again to **unlock** the seed's exit.



NEUMASEM electronical controller for independent folding parts

To **lock** the seed's exit from the arms on the folding parts, press  (to **lock** the left side in the driving direction) or  (to **lock** the right side in the driving direction). The screen will display the indicating arrow.



Press  or  again to **unlock** the seed's exit and change back to normal position.



NEUMASEM PLUS electronical controller

Press  to **lock** the seed's exit from the arms on the folding parts. The screen will display an arrow indicating the selected mode.

Press  again to **unlock** the seed's exit and change back to normal position.

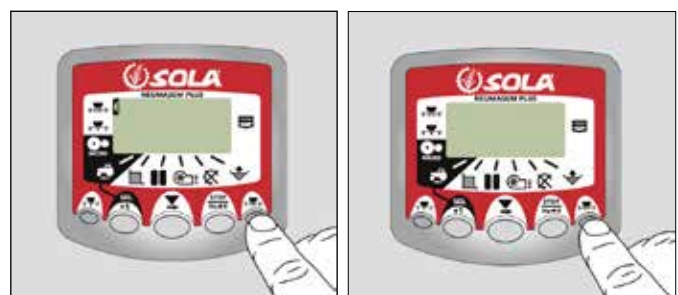

10- MAINTENANCE



IN CASE OF MALFUNCTION, STOP THE MACHINE IMMEDIATELY AND REMOVE THE IGNITION KEY. LEAVE THE TRACTOR AND VISUALLY INSPECT AND EVALUATE THE EXTENT OF THE PROBLEM. PERFORM THE REQUIRED OPERATIONS ON THE MACHINE BEFORE RESTARTING IT.



MAINTENANCE OPERATIONS MUST BE PERFORMED IN PROPERLY EQUIPPED GARAGES BY QUALIFIED PERSONNEL.



NO REPAIRS SHOULD BE PERFORMED WITHOUT THE NECESSARY SKILLS AND KNOWLEDGE. IT IS ESSENTIAL THAT THE INSTRUCTIONS DETAILED IN THIS MANUAL ARE STRICTLY FOLLOWED. IF THESE INSTRUCTIONS ARE MISSING, PLEASE CONTACT THE SEED DRILL'S PROVIDER OR QUALIFIED PERSONNEL.



IN ORDER TO PERFORM MAINTENANCE OR REPAIR OPERATIONS TO THE SEED DRILL, IT IS ESSENTIAL TO USE PROPER **PERSONAL PROTECTIVE EQUIPMENT (PPE)**: SAFETY BOOTS AND GLOVES, HEARING PROTECTION, DUST MASK AND PROTECTIVE GLASSES).



IT IS RECOMMENDED TO AVOID WEARING LOOSE CLOTHING SINCE IT MAY BECOME TANGLED WITH THE MACHINE'S MOVING PARTS.

Before performing any task on the machine, it is essential to take into account the following factors:

- Maintaining or repairing the machine should be performed on a flat and compact ground. Before starting any of these tasks, the tractor's engine must be turned off and the ignition key removed.
- The chosen device to raise the machine needs to be appropriate for the operations to be performed. Please ensure that all safety regulations are observed.
- Always use appropriate protective equipment for any task to be performed.
- In case compressed air is used to clean the seed drill, or an airbrush is used to paint any machine's part, you are required to wear protective glasses and mask.
- If any operation needs to be performed on a part of the machine which is at more than 1,5 metres height from the ground, check if it is possible to reach this part using the seed drill's access points (seed drill's access ladder). If not possible, use either a ladder or a platform which is in accordance with the current safety regulations.

- Prolonged and/or repetitive skin contact with fuel and lubricants is harmful. In case these products come accidentally into contact with the eyes or other sensitive parts, wash well the affected parts with clean water. In case of ingestion, contact the medical services immediately.

10.1 CHECKING FREQUENCY

The frequency of the checks indicated below is provided as a guideline. It may vary depending on machine application and use, environment, temperature, weather conditions, etc.

- BEFORE STARTING THE SOWING SEASON:

Check the general operation of the machine. Perform this check without any seeds inside the hopper.

Check that the plastic components of the seed drill are in good condition. The wear of this material due to natural ageing or to the presence of rodents causes damages to these components.

Check that the mechanical components are in good condition and not rusty.

Clean the parts of the seed drill which are permanently in contact with seeds, such as hopper and metering box.

Check that the signal lamps work properly.

Check that the unions and the ducts of the hydraulic system do not show oil leaks.

- PERIODICALLY:

Check periodically that the sowing equipment is clean. The accumulation of earth, stones, grass, etc. may block the sowing ducts.

Before washing the seed drill with water, check that no seeds or fertilizer are inside the hoppers or the metering boxes.

After washing the machine, turn on the fan for some minutes in order to remove the moisture from the metering units and the pneumatic system.

Check that all the screws are in good condition, especially the ones which are in contact with the ground. Tighten every single screw and bolt.

Check that the metering box and the pneumatic system do not contain any residue (such as seed or fertilizer residue, dust, etc). Residue accumulation may damage the pneumatic system.

- END OF SOWING SEASON

Wash the seed drill well with a lot of water, making sure that no seeds, fertilizer or other products remain inside the hoppers, metering boxes or ducts. Wash especially the parts of the seed drill which are in contact with chemical products.

Properly lubricate the moving parts of the seed drill.

Repaint any metallic component which has lost its paint due to wear.

To store the seed drill properly, cover it with tarpaulin and keep it in a dry place. Thoroughly check all components of the machine and replace the ones which are damaged or worn.



KEEP THE SOWING EQUIPMENT CLEAN. THE ACCUMULATION OF EARTH, STONES, GRASS, ETC. MAY BLOCK THE SOWING DUCTS.

A careful maintenance of the seed drill ensures proper functioning and long service life of the machine.



BEFORE PERFORMING THESE OPERATIONS, THE SEED DRILL'S ENGINE MUST BE TURNED OFF AND THE IGNITION KEY REMOVED.

The next table shows the maintenance operations to be performed on the machine along with their (GUIDANCE) frequency:



AFTER THE FIRST 10 HOURS OF WORK, TIGHTEN THE SCREWS THAT SECURE THE METERING UNITS, THE THREE POINT LINKAGE, THE WHEELS AND THE TRACK MARKERS' SUPPORTS.

SEED DRILL'S PART	TASK TO BE PERFORMED	NUMBER OF HOURS			
		20	50	100	500
Machine's components	Greasing of all the components	•	•		
Fan	Adjusting the belt's tension (in versions equipped with mechanical fan)				•
Drive wheels	Check of the tyre pressure			•	
Chain transmissions	Lubrication of the transmission chains		•		
	Adjusting the transmission chains' tension				•

10.2 LUBRICATION

The following parts should be lubricated with SOLID CALCIUM GREASE.

- All the joints of the cardan shaft should be greased, **daily**.
- The joints of the folding parts should be greased, **every 100 Ha.**
- Both the wheel's and transmission's bushings should be, **every 400 Ha.**
- Transmission chain should be greased, **once a year.**



AFTER FINISHING A SOWING SEASON, ALL CHAINS AND JOINTS SHOULD BE CLEANED AND GREASED.

10.3 DISTRIBUTOR HEAD AND SEED HOSES

Before starting work, check that the distributor head and the seed hoses are not blocked.

To perform the check, follow these steps:

- 1- Make sure that the fan is on and the hopper is full. Use then the crank provided to turn the wheel controlling the distributor's transmission a few times.
- 2- Check that the seeds are coming out from every tine coulters.

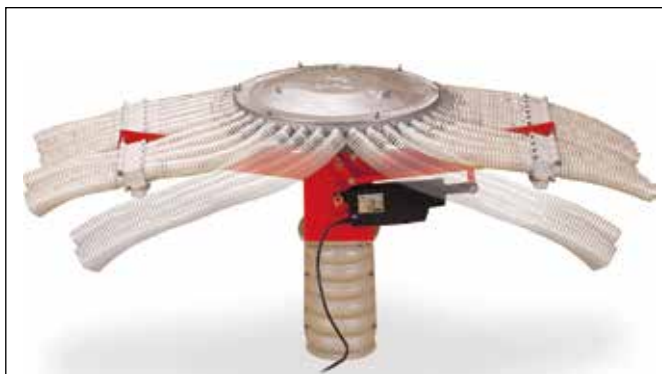

IF ANY ABNOMALITY SHOWS UP, DO AS FOLLOWS:

- 1- STOP the machine so that the fan is off.
- 2- Take apart the cap of the distributor's head.
- 3- Check that there are no foreign bodies inside.
- 4- Remove foreign bodies in the case that they exist.

10.4 TYRES PRESSURE

Indicated pressures are provided by the manufacturer, at maximum load.

In general use and especially when working on irregularly tilled terrains, it is recommended to use a slightly lower pressure to absorb the ground's irregularities and get a higher regularity in sowing.

TYRE	PRESSURE (kg/cm ²)
340/55-16	3,75
10.0/75-15,3 12PR	6,1
18x7"- 8" 14PR	9

11. DOSAGE TABLES



INDICATED QUANTITIES SHOWN IN THE FOLLOWING TABLE SHOULD BE CONSIDERED FOR GUIDANCE ONLY, FORESEEN FLOWS CAN VARY DEPENDING ON THE ACCIDENTAL PRESENCE OF DISINFECTING PRODUCTS, UNEVEN SEED SIZE, DENSITY, HUMIDITY, ETC.



FOR PRECISION SOWING, FOLLOW DOSING PROCESS DESCRIBED IN SECTION 6 OF THIS MANUAL.

	WHEAT	RYE	BARLEY	OATS	BEANS	PEAS	LUPIN	CAROB	CORN	CORN		RAPE	FIELD CLOVER	GRASS	TURNIPS				
Spec. weight (kg/l)	0,77	0,74	0,68	0,5	0,85	0,81	0,76	0,83	0,79	0,36	Spec. weight (kg/l)	0,65	0,77	0,39	0,7				
Adj. dosing scale value	Regular seeds kg/ha (Bolt in position N)										Adj. dosing scale value	Fine seeds kg/ha (Bolt in position F)							
10	31,9	31,9	30,7	22,7	21,6	20,4	26,8	30,7	7,7	-	2,5	2,04	1,02	2,17	1,10	-	-	2,43	1,15
15	48,5	47,3	46,0	33,0	39,6	38,3	43,5	48,5	23,0	17,9	5	4,35	2,17	4,99	2,43	-	-	4,35	2,30
20	66,5	63,9	61,3	44,3	58,7	56,3	58,7	66,5	44,7	24,3	7,5	6,51	3,19	8,18	4,09	2,68	1,34	7,15	3,53
25	81,9	79,3	75,4	54,6	75,4	74,1	75,4	85,6	66,5	31,9	10	8,69	4,35	11,54	5,75	4,99	2,43	9,58	4,79
30	99,7	95,8	90,7	68,0	93,3	93,3	92,0	103	88,2	39,6	12,5	10,82	5,49	14,74	7,29	6,90	3,45	12,06	6,01
35	117	112	106	78,3	111	112	108	122	110	47,3	15	13,19	6,51	17,21	8,69	8,82	4,41	14,32	7,15
40	134	128	122	89,7	129	130	124	139	132	-	17,5	15,25	7,54	20,30	10,10	10,72	5,37	16,70	8,38
45	150	144	137	101	147	148	140	159	149	-	20	17,42	8,69	22,98	11,54	12,68	6,27	19,17	9,58
50	166	161	153	112	165	166	158	176	167	-	22,5	19,68	9,84	25,46	12,68	14,32	7,15	20,61	10,30
55	184	176	166	124	182	186	174	194	186	-	25	21,85	10,82	26,28	13,19	15,56	7,79	22,05	11,03
60	201	192	182	135	201	204	190	212	203	-		N	F	N	F	N	F	N	F
65	218	208	197	147	218	223	207	231	222	-	N= regular speed F= microdosing								
70	236	225	212	159	236	240	224	249	239	-	PREVIOUS FLOW TEST								
75	254	241	228	170	255	258	240	267	256	-	Seed drill		Turns						
80	270	258	241	181	271	276	257	285	273	-	400	27,4							
85	285	275	257	192	289	297	273	303	292	-	450	24,4							
90	303	289	272	203	307	314	289	322	309	-	500	22,0							
95	321	305	288	214	324	332	307	340	327	-	600	18,3							
100	337	322	303	226	341	350	322	358	345	-	700	15,7							
105	353	339	318	238	358	369	339	377	364	-	Number of turns performed to the small wheel to simulate the sowing of 250m ² . Flow in kg/ha is obtained by multiplying collected weight by 40.								
110	371	356	334	249	377	387	356	395	381	-									

TABLE FOR ARES-2713 WITH FLOTATION WHEELS 10.0/75-15,3

When the amounts to be sown are very small (dosing scale value ≤ 10), a more uniform sowing can be obtained using microdosing, even in the case of regular seeds (cereal and big seeds).

	WHEAT	RYE	BARLEY	OATS	BEANS	PEAS	LUPIN	CAROB	CORN	CORN		RAPE	FIELD CLOVER	GRASS	TURNIPS				
Spec. weighth (kg/l)	0,77	0,74	0,68	0,5	0,85	0,81	0,76	0,83	0,79	0,36	Spec. weighth (kg/l)	0,65	0,77	0,39	0,7				
Adj. dosing scale value	Regular seeds kg/ha (Bolt in position N)										Adj. dosing scale value	Fine seeds kg/ha (Bolt in position F)							
10	31	31	29,8	22	21	19,8	26	29,8	7,44	-	2,5	1,98	0,99	2,11	1,07	-	-	2,36	1,12
15	47,1	45,9	44,6	32	38,4	37,2	42,2	47,1	22,3	17,4	5	4,22	2,11	4,84	2,36	-	-	4,22	2,23
20	64,5	62	59,5	43	57	54,6	57	64,5	43,4	23,6	7,5	6,32	3,1	7,94	3,97	2,6	1,3	6,94	3,43
25	79,5	76,9	73,2	53	73,2	71,9	73,2	83,1	64,5	31	10	8,43	4,22	11,2	5,58	4,84	2,36	9,3	4,65
30	96,7	93	88	66	90,5	90,5	89,3	100	85,6	38,4	12,5	10,5	5,33	14,3	7,07	6,7	3,35	11,7	5,83
35	114	109	103	76	108	109	105	118	107	45,9	15	12,8	6,32	16,7	8,43	8,56	4,28	13,9	6,94
40	130	124	118	87	125	126	120	135	128	-	17,5	14,8	7,32	19,7	9,8	10,4	5,21	16,2	8,13
45	146	140	133	98	143	144	136	154	145	-	20	16,9	8,43	22,3	11,2	12,3	6,08	18,6	9,3
50	161	156	148	109	160	161	153	171	162	-	22,5	19,1	9,55	24,7	12,3	13,9	6,94	20	9,99
55	179	171	161	120	177	180	169	188	180	-	25	21,2	10,5	25,5	12,8	15,1	7,56	21,4	10,7
60	195	186	177	131	195	198	184	206	197	-		N	F	N	F	N	F	N	F
65	212	202	191	143	212	216	201	224	215	-	N= regular speed F= microdosing								
70	229	218	206	154	229	233	217	242	232	-	PREVIOUS FLOW TEST								
75	246	234	221	165	247	250	233	259	248	-	Seed drill	Turns							
80	262	250	234	176	263	268	249	277	265	-	400	26,5							
85	277	267	249	186	280	288	265	294	283	-	450	23,5							
90	294	280	264	197	298	305	280	312	300	-	500	21,2							
95	311	296	279	208	314	322	298	330	317	-	600	17,7							
100	327	312	294	219	331	340	312	347	335	-	700	15,1							
105	343	329	309	231	347	358	329	366	353	-	Number of turns performed to the small wheel to simulate the sowing of 250m ² . Flow in kg/ha is obtained by multiplying collected weighth by 40.								
110	360	345	324	242	366	376	345	383	370	-									

TABLE FOR ARES-2713 WITH FLOTATION WHEELS 340-50.16

When the amounts to be sown are very small (dosing scale value <= 10), a more uniform sowing can be obtained using microdosing, even in the case of regular seeds (cereal and big seeds).



MAQUINARIA AGRÍCOLA SOLÀ, S.L.
Ctra. de Igualada, s/n. 08280 CALAF (Barcelona) Spain
Tel. (0034) 93 868 00 60 - Fax (0034) 93 868 00 55

