



# PM300 - 332 - 400 PLANTER MONITOR



# TABLE OF CONTENTS

---



<b>Safety Notices .....</b>	<b>1</b>
<b>Introduction .....</b>	<b>3</b>
System Overview .....	3
Specifications .....	5
<b>Major Features .....</b>	<b>7</b>
Performance .....	7
Console/Display .....	7
Compatibility .....	7
User Aid .....	7
<b>Quick Start Guide.....</b>	<b>9</b>
Planter Configuration .....	9
Number of Rows .....	9
Row Spacing .....	10
Ground Speed Configuration .....	11
Help Card.....	12
<b>Key Functions .....</b>	<b>15</b>
On/Off Key .....	15
Alarm Cancel Key .....	15
Enter Key .....	16
Escape Key .....	16
Up and Down Arrow Keys.....	16
Left and Right Arrow Keys .....	16
Operate Key .....	16
Planter Setup Key .....	16
Ground Speed Setup Key .....	17
Limits Setup Key .....	17
Display And Service Key .....	17
Accessory Setup Key .....	17
Seed Count Mode Key .....	17
Speed Area Mode Key .....	17
Editing Screen Fields Using Keys.....	18
Highlighted Digit for Editing .....	18
<b>Installation .....</b>	<b>19</b>
Standard Mounting Bracket .....	19
Optional Mounting 3D Adjustable Bracket .....	20
Installing Console Harnesses .....	21
Installing Implement Harness and Sensors .....	22

# TABLE OF CONTENTS

---



<b>Advanced Setup .....</b>	<b>23</b>
Planter and Ground Speed .....	23
Row Setup (Auto Assigned) .....	23
Ground Speed Setup .....	24
Manual Ground Speed Constant Entry .....	25
Accessory Setup (Optional) .....	26
Limits Setup (Population) (Optional) .....	28
Target Population .....	28
HI Population/Low Population .....	29
Population Adjustment .....	29
Population Response Rate .....	29
Units of Measurement, Backlighting and Alarm Volume Control .....	30
Service Screen .....	30
Security Screen .....	31
<b>Auxiliary Modes .....</b>	<b>33</b>
Speed Area Mode .....	33
Seed Count Mode .....	33
<b>Monitoring Planting .....</b>	<b>35</b>
Operate Screen Setup .....	35
Customizing the Upper Parameter Window .....	35
Customizing the Lower Parameter Window .....	37
Available Planting Parameters .....	38
Average Population .....	38
Minimum/Average/Maximum Population .....	39
Population Row Scan .....	39
Average Spacing .....	39
Minimum/Average/Maximum Spacing .....	39
Spacing Row Scan .....	39
Seeds per Distance .....	39
Minimum/Average/Maximum Seeds per Distance .....	39
Seeds per Distance Row Scan .....	39
Field Area 1 .....	40
Field Area 2 .....	40
Total Area .....	40
Speed .....	40
Area per Hour .....	40
Fan .....	40
Shaft .....	40
Flow .....	40
<b>Alarms .....</b>	<b>41</b>
Hopper Level .....	41
Row Failure .....	41
All Rows Failure .....	42
Hi/Low Population Warning .....	43
Fan Speed Low/Hi Limit Warning .....	43
Shaft Speed Low/Hi Limit Warning .....	44
Flow Low/Hi Limit Warning .....	44
Failed Ground Speed Sensor .....	45
Battery Hi/Low .....	45
Self-Test Failure .....	46
Hi Ground Speed Exceeded (Optional) .....	46

# TABLE OF CONTENTS

---



<b>Troubleshooting</b> .....	<b>47</b>
Monitor Will Not Power On .....	47
Row Failure or Hi/Low Alarm When Row is Planting Properly.....	47
Hopper Alarm Does not Sound When Hopper is Empty .....	48
Hopper Alarm Does Not Sound When Hopper is Full.....	48
System Voltage Alarm .....	48
Accessory Alarm Sounds When Shaft, Fan or Flow is Working .....	49
Ground Speed Alarm Sounds When Forward Movement .....	49
Ground Speed High Alarm Sounds .....	49
Self-Test Alarm .....	50
Connector Pin-Outs .....	51
Connector Pin-Outs .....	52
<b>Warranty</b> .....	<b>57</b>

# TABLE OF CONTENTS

---





## SAFETY NOTICES

Safety notices are one of the primary ways to call attention to potential hazards.



**This Safety Alert Symbol identifies important safety messages in this manual. When you see this symbol, carefully read the message that follows. Be alert to the possibility of personal injury or death.**

---

### **⚠ WARNING**

Use of the word **WARNING** indicates a potentially hazardous situation which, if not avoided, could result in death or serious injury.

---

### **⚠ CAUTION**

Use of the word **CAUTION** with the Safety Alert Symbol indicates a potentially hazardous situation which, if not avoided, may result in minor or moderate injury.

---

### **CAUTION**

Use of the word **CAUTION** without the safety alert symbol indicates a potentially hazardous situation which, if not avoided, may result in equipment damage.

---

# OPERATOR'S MANUAL

---





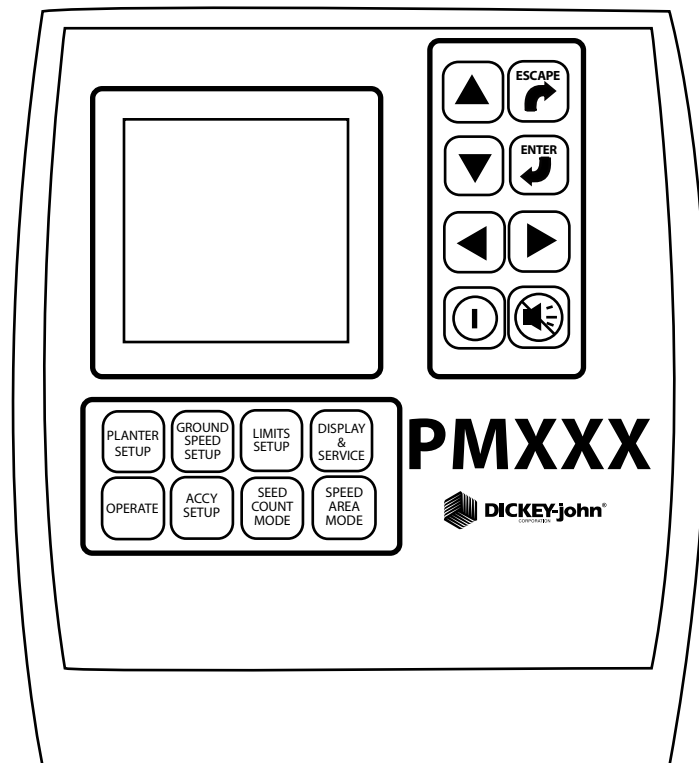
## INTRODUCTION

### SYSTEM OVERVIEW

The DICKEY-john PM300, PM332, and PM400 Planter Monitors offer features to monitor 16, 32, and 36 rows, respectively. The units monitor seed or fertilizer rows, two hopper levels, and a frequency input (shaft, fan, or flow). The monitors are compatible with DICKEY-john seed, flow, hopper level, and gear sensors. The units store all configuration data in nonvolatile memory, retaining information even when disconnected from power. Figure 1 provides an illustration of a generic console.

The PM300, PM332, and PM400 are designed to meet the custom needs of individual users. The display may be configured to output a comprehensive set of planter parameters. The user selects the type and number of parameters to be monitored. Choices may be as simple as monitoring population and field area or may be more complex. Similarly, blink or fail mode information may be viewed as a bar graph, gauge, or symbol. Information may be viewed in large format (for ease of viewing), or small format (for entire planter view). Auto-scrolling and arrow key override are used to maintain control of real-time information required by the user.

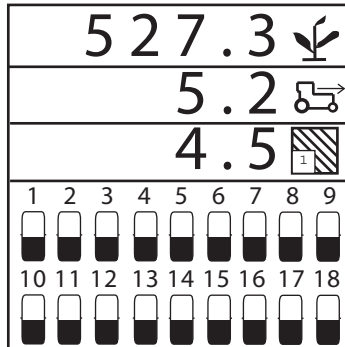
**Figure 1**  
**PM300, PM332, and PM400**



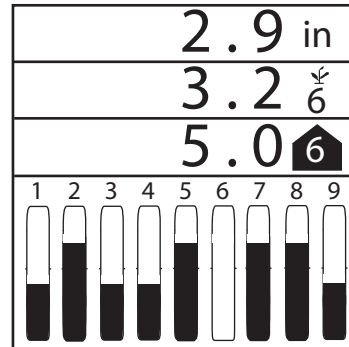




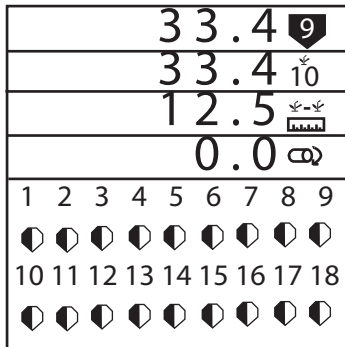
**Figure 2**  
**User-Definable Display Examples**



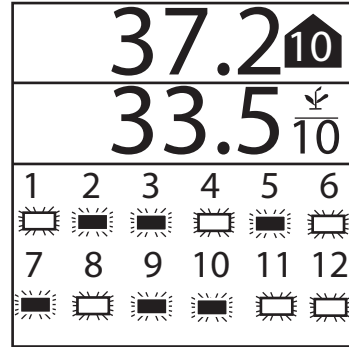
**Graphic mode:** average population, speed, and field 1 area output with bar graphs



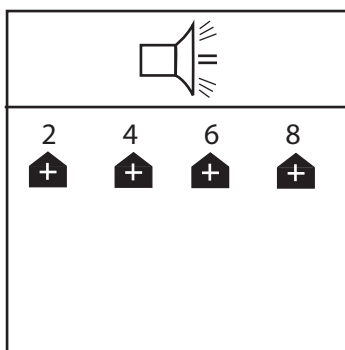
**Text mode:** average spacing, spacing scan and min/max/avg spacing output with bar graphs



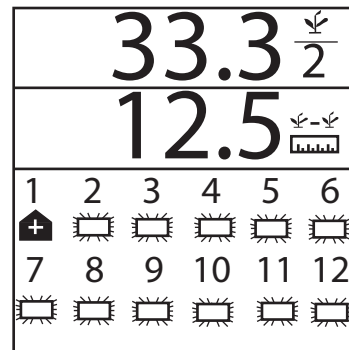
Min/max/avg population, population row scan, avg speed spacing, and shaft speed with gauges



Min/max/avg population and row scan with blinking row symbols



Rows 2, 4, 6, 8 (above limit) alarm screen



Row scan and average spacing with blinking symbols and row 1 hi alarm (alarm cancel returns user to operate screen)



## SPECIFICATIONS

<b>Power</b>	10–16 VDC, 5 A maximum
<b>Operating temperature range</b>	-20°C to 70°C (-4°F to 158°F)
<b>Storage temperature range</b>	-40°C to 85°C (-40°F to 185°F)
<b>Size</b>	18.4 cm W x 20.1 cm H x 4.3 cm D (7.3" W x 7.9" H x 1.7" D)
<b>Weight</b>	4.4 lbs for 16-row PM300 system 4.8 lbs for 32-row PM332 system 6.4 lbs for 36-row PM400 system *Weight includes console and attached cables (battery power cable and signal cable that extends to the drawbar).
<b>Wire Harnesses</b>	The PM300, PM332, and PM400 include integrated harnesses to supply the unit's power (fused), ground speed input, and sensor inputs (to drawbar). The connectors are compatible with existing DICKEY-john harnesses. DICKEY-john can supply custom harnesses required for sensor inputs.
<b>Sensors</b>	Compatible with existing DICKEY-john sensors
<b>Standard mounting</b>	Rear attached horizontal or vertical mounting bracket Mounting bracket weighs 1.0 lb.
<b>Optional mounting</b>	Three-axis adjustable mounting bracket
<b>Contrast adjustment</b>	Automatic temperature compensation for contrast
<b>Backlight adjustment</b>	Three settings for full sun, daytime, or nighttime use
<b>CE certified</b>	
<b>Dust and moisture resistant</b>	

# OPERATOR'S MANUAL

---





## MAJOR FEATURES

### PERFORMANCE

- Planter monitoring of 16 row (PM300), 32 rows (PM332), or 36 rows PM400
- Monitoring of ground speed, two hopper levels, one frequency function (fan, shaft, or flow)
- Easy and flexible configuration
- User-definable view of two, three, or four functions (all are available):
  - Average Population
  - Average Seed Spacing
  - Average Seeds Per Distance
  - Population Row Scan
  - Seed Spacing Row Scan
  - Seed Per Distance Row Scan
  - Minimum, Maximum, Average Row Population
  - Minimum, Maximum, Average Row Spacing
  - Minimum, Maximum, Average Spacing Per Distance
  - Field Area 1
  - Field Area 2
  - Total Area 3
  - Ground Speed
  - Fan, Shaft, or Flow Frequency
- User-definable row information:
  - Bar Graph
  - Wiper Gauge
  - Symbols (Failure mode)
  - Symbols flashing proportional to seeding rates

### CONSOLE/DISPLAY

- Large, user friendly keys
- User-definable text size ease of viewing
- Graphic or text-based output labels
- Backlit graphic display for nighttime use
- Three-level backlight intensity adjustment
- Large, concise error messages displayed with audible alarm
- English or metric units
- Horizontal and vertical mounting (optional 3D adjustment bracket)

### COMPATIBILITY

- Compatible with DICKEY-john sensors
- Plug-in replacement for other DICKEY-john monitors
- Optional support of RS-232 based data logging

### USER AID

- Help card

# OPERATOR'S MANUAL

---





## QUICK START GUIDE

Three inputs are required for monitor operation.

- Number of rows
- Row spacing
- Ground speed constant

Selecting a pre-programmed planter configuration provides easy set-up of planter row width, number of rows, implement width, and row types.



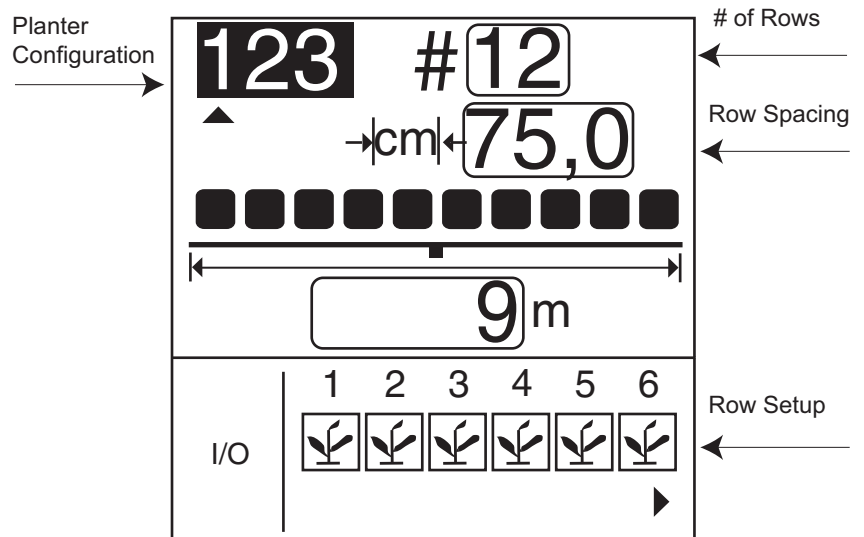
Planter Setup key

### PLANTER CONFIGURATION

To program the planter configuration, select the **Planter Setup** key. The **Planter Configuration** screen will be displayed.

Figure 3

Planter Configuration Screen



The PM300, PM332, and PM400 can store three planter configurations for users with split row planters or multiple planters and seeders, but many users store only one configuration.

To select a planter configuration number (1, 2, or 3)

1. Press **Enter** to highlight arrow indicator ( ▲ ) and move using the Left and Right keys to make a selection.
2. Press **Enter** to confirm the selection.

### NUMBER OF ROWS

To change number of rows:

1. Use the **Left and Right Arrow** keys to highlight the number of rows field.



Enter key



Left and Right Arrow keys



Enter



Up and Down Arrow keys



Operate key



Escape key

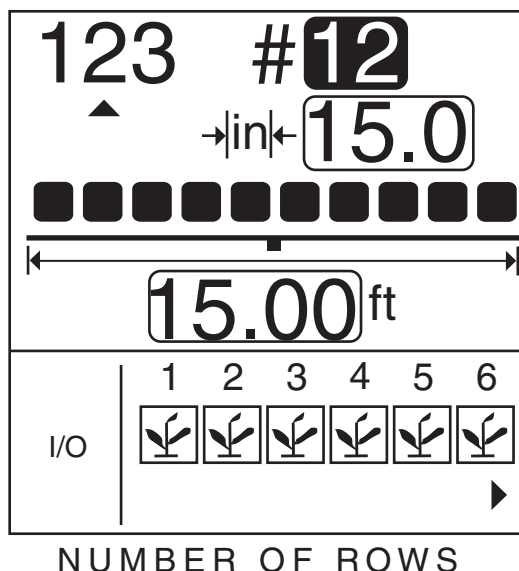


Left and Right Arrow keys

2. Press **Enter** to modify the number of rows as shown in Figure 4. Use the **Right and Left Arrow** keys to select the digit to change. Use the **Up and Down Arrow** keys to edit the selected digit. Use the Up Arrow key to increase the value; use the Down Arrow key to decrease the value.
3. Press the **Enter** key to confirm the selection. Enter the row spacing in the same manner.
4. Once the new values are entered, select either the **Escape** or **Operate** key to return to the **Operate** (main) screen.

Figure 4

Number of Rows Screen



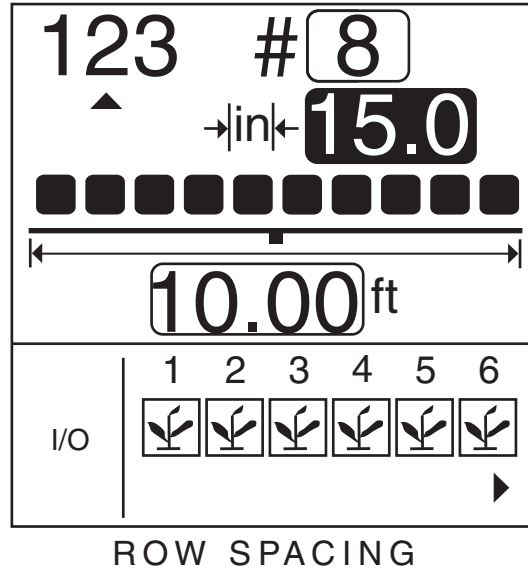
## ROW SPACING

### To change row spacing:

1. Press Planter Setup key.
2. Use the Down arrow to highlight the row spacing field (refer to Figure 5).
3. Press **Enter** to select the field.
4. Use the **Left and Right Arrow** keys to select a digit for editing.
5. When a digit is highlighted, use the **Up and Down Arrow** keys to edit the value displayed. Use the Up Arrow key to increase the value; use the Down Arrow key to decrease the value.
6. When the field shows the correct planter row spacing, press **Enter** to confirm the selection.
7. Once the new values are entered, select either the **Escape** or **Operate** key to return to the **Operate** (main) screen.



**Figure 5**  
**Row Spacing Screen**

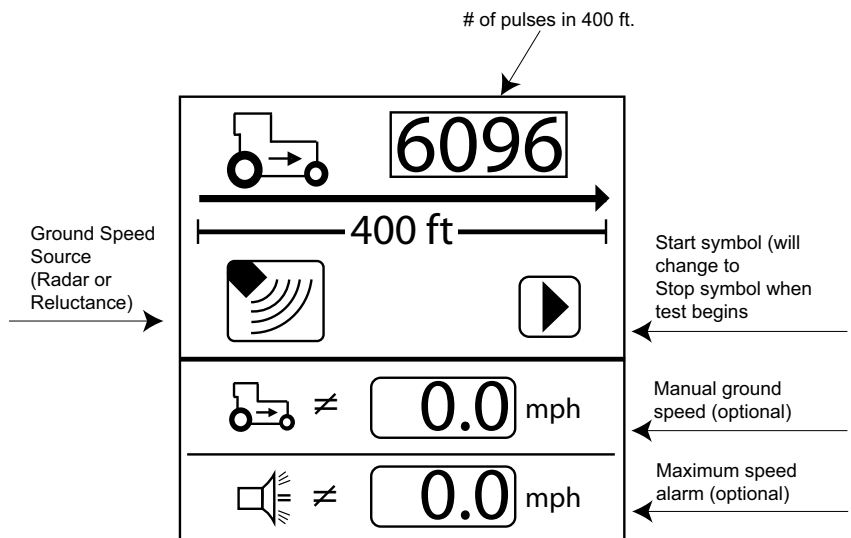


Ground Speed Setup key

**GROUND SPEED CONFIGURATION**

To perform Ground Speed Configuration, select the **Ground Speed Setup** key. The **Ground Speed Setup** screen will display (refer to Figure 6).

**Figure 6**  
**Ground Speed Setup Screen**







*Enter key*



*Operate key*



*Escape key*

## To perform a new calibration:

1. Measure a 400 foot (122 meter) course, clearly marking the beginning and end.
2. Using the Arrow keys, highlight the **Start** softkey on the screen ( ► ).
3. Begin moving the tractor forward at 2-5 mph.
4. When the tractor is even with the beginning marker, press the **Enter key** to start the 400-foot calibration.
5. After the calibration has begun, the softkey on the screen will change to a **Stop** ( ■ ) softkey. Drive 400 feet and stop the vehicle.
6. Select the **Enter** key to stop the calibration. The new calibration factor will be displayed on the window.
7. Once the **Stop** key is selected, the value will be saved upon screen exit. Selecting the **Escape** key while the calibration is running will not save the value.
8. Select either the **Escape** or **Operate** key to return to the **Operate** (main) screen.

## HELP CARD

The help card (Figure 7) may be cut out to provide a compact reference for definitions, set-up screens, and general operating information.

# OPERATOR'S MANUAL



Figure 7

## Help Card

<p>Planter Setup</p>				<p>Ground Speed</p>				<p>Limits Setup</p>				<p>User Preference</p>				<p>Display and Service Menus</p> <p>Service</p>											
<p>Operate (main)</p>				<p>Accessory Setup</p>				<p>Seed Count</p>				<p>Speed Area Distance</p>				<p>Functions (top half)</p>				<p>Rows output (bottom half)</p>							
<p>Use keys to select screen                  Use ▲◀▶▼ (arrow keys) to select item                  Use ENTER to modify highlighted item                  Use ▲◀▶▼ (arrow keys) to change items/digits or to select digits                  Use ENTER to accept data or OPERATE to accept data and return to the OPERATE screen</p>																											
<p>Average</p> <p>Population</p>				<p>Seed Spacing</p>				<p>Seeds per Distance</p>				<p>Field Area 1</p>				<p>Field Area 2</p>				<p>Total Area</p>							
<p>Row Scan</p> <p>Population</p>				<p>Seed Spacing</p>				<p>Seeds per Distance</p>				<p>Speed</p>				<p>Area/hour</p>				<p>Distance</p>							
<p>Minimum</p> <p>Maximum</p> <p>Average</p> <p>Population</p>				<p>Seed Spacing</p>				<p>Seeds per Distance</p>				<p>Shaft</p>				<p>Fan</p>				<p>Flow</p>							
<p>Warning</p>		<p>Hi/Lo</p>		<p>No flow</p>		<p>Hopper</p>		<p>All Rows Failed</p>		<p>Planter Lifted</p>		<p>No Speed Input</p>															
<p>Start</p>		<p>Stop</p>		<p>Reset</p>		<p>Security</p>		<p>Password</p>		<p>Save Password</p>		<p>Configuration</p>															
<p>Alarm</p>		<p>English/Metric</p>		<p>Back light</p>		<p>Graphic/Text Label</p>		<p>Population Adjust</p>		<p>Response Rate</p>																	

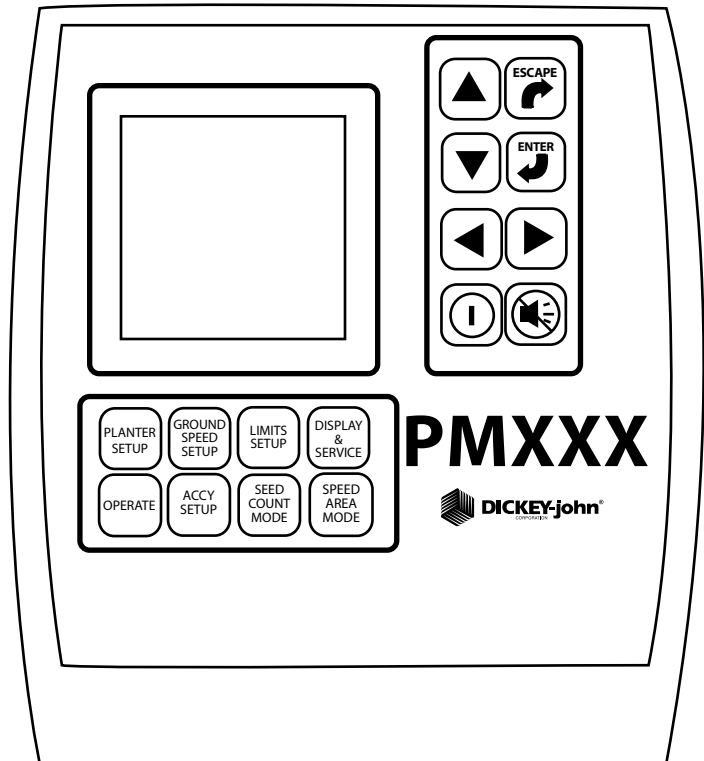




## KEY FUNCTIONS

Figure 8

Keys



### ON/OFF KEY

The **On/Off** key activates the unit. During power up, the monitor performs internal self-tests, illuminates the display, sounds the alarm, and determines which sensors are connected to the system. Pressing and holding the key for one second when the power is ON will turn the power OFF, independent of the screen being displayed.



On/Off key

### ALARM CANCEL KEY

During normal operation, selecting the **Alarm Cancel** key acknowledges the alarm condition displayed on the screen. Active row alarms are reset after an ALL ROWS FAILURE condition or a power down-up sequence occurs. If the error condition continues, the key must be selected again to cancel the alarm. When no alarms are active, the volume may be modified by selecting and holding the **Alarm Cancel** key.



Alarm Cancel key



*Enter key*



*Escape key*



*Up and Down Arrow keys*



*Left and Right Arrow keys*



*Operate key*



*Planter Setup key*

## ENTER KEY

The **Enter** key selects a highlighted item for data modification. After changing the parameter values, **Enter** accepts the modified data.

## ESCAPE KEY

On the **Operate** (main) screen, select and hold the **Escape** key for four seconds to clear an area accumulator if it is located on the top line of the display.

When navigating through sub-menus, the **Escape** key moves the user back one selection. After changing parameter values, selecting **Escape** accepts the modified data. The **Escape** key also serves as an alarm cancel key.

## UP AND DOWN ARROW KEYS

On the **Operate** (main) screen, the **Up** and **Down Arrow** keys are used to manually select the parameters viewed at the top of the display. They are inactive if all parameters are already displayed (number of parameters are equal to or less than number of lines).

On the **Operate** (main) screen, the arrows are used to navigate between options. On set-up screens, the arrows are used to navigate between options or to change a digit/option.

## LEFT AND RIGHT ARROW KEYS

On the **Operate** (main) screen, the **Left** and **Right Arrow** keys are used to manually select the rows viewed at the bottom of the display. They are inactive if all rows are already displayed. On other screens, the arrows are used to navigate between options.

## OPERATE KEY

The **Operate** (home) key is used to return the user to the **Operate** (main) screen.

If data is changed, it is saved when this key is selected.

## PLANTER SETUP KEY

The **Planter Setup** key is used to navigate to the **Planter Setup** screen for input of the number of rows, row spacing, implement width (optional), and row type (population — default, blockage, skipped, or disabled).

If data on another screen is changed, it is saved when this key is selected.



*Ground Speed Setup key*



*Limits Setup key*



*Display and Service key*



*Accessory Setup key*



*Seed Count Mode key*



*Speed Area Mode key*

## GROUND SPEED SETUP KEY

The **Ground Speed Setup** key is used to navigate to the **Ground Speed Setup** screen for input of the ground speed calibration (or manual entry of ground speed calibration number), manual ground speed (used if no ground speed is available), and ground speed maximum limit (optional).

If data on another screen is changed, it is saved when this key is selected.

## LIMITS SETUP KEY

The **Limits Setup** key is used to navigate to the **Limits Setup** screen for input of the upper limit (optional), target population value (optional), lower limit (optional), population adjustment factor (optional for sensors that count less than 100% of all seeds), and response rate (optional to increase or decrease the console response rate).

If data on another screen is changed, it is saved when this key is selected.

## DISPLAY AND SERVICE KEY

The **Display And Service** key is used to navigate to the **Display & Service Setup** screen for access to the function, row indicators, service, and security sub-menus; English/Metric units selection; display backlight intensity; and alarm volume.

If data on another screen is changed, it is saved when this key is selected.

## ACCESSORY SETUP KEY

The **Accessory Setup** key is used to navigate to the **Accessory Setup** screen for selection of a fan (RPM) / shaft (RPM) / or flow (G/MIN or L/min) labels, upper and lower alarm limits, and calibration (or manual calibration number entry).

If data on another screen is changed, it is saved when this key is selected.

## SEED COUNT MODE KEY

The **Seed Count Mode** key is used to navigate to the **Seed Count** screen. This mode allows users to test planters for proper operation prior to field use.

If data on another screen is changed, it is saved when this key is selected.

## SPEED AREA MODE KEY

The **Speed Area Mode** key is used to navigate to the **Speed Area Distance** screen. This mode allows use of the console for non-planting operations. This mode is also used to start, stop, or clear the three independent area accumulators (FIELD AREA 1, FIELD AREA 2, and TOTAL AREA).

If data on another screen is changed, it is saved when this key is selected.

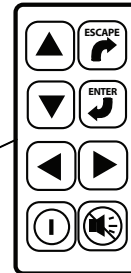
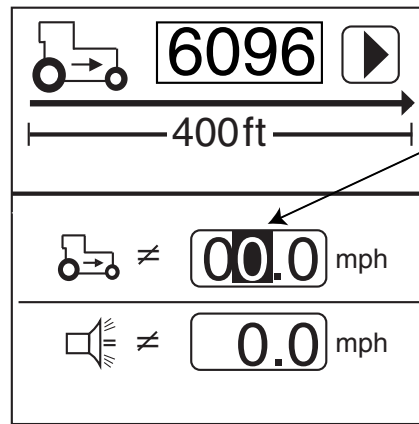


## EDITING SCREEN FIELDS USING KEYS

The term "highlight" used throughout the manual refers to pressing a key to activate and move the blinking cursor until the desired digit on the screen is highlighted. Pressing **Enter** accepts and confirms the selection.

### HIGHLIGHTED DIGIT FOR EDITING

A highlighted digit can be edited by using the Arrow keys on the Control Panel. Press Enter to accept and confirm the selection.



GNDSPD CONSTANT



## INSTALLATION

The monitor is tested and inspected before shipping to ensure the unit is fully operational and meets measurement specifications. Inspect for damage that may have occurred during transit. Save all packing materials until the inspection is complete. If damage is found, immediately file a claim with the carrier and notify your DICKEY-john Sales Representative.

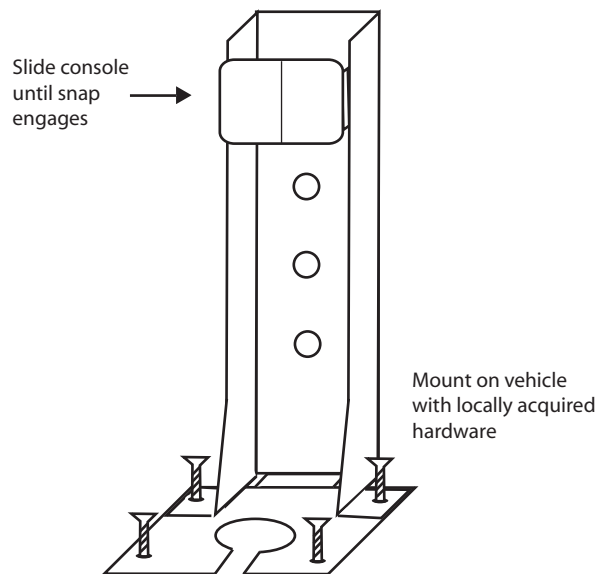
### STANDARD MOUNTING BRACKET

*NOTE: When mounted to a vertical surface, a tie-wrap may be used to secure the cables to the bottom of the bracket.*

Install the mounting bracket at the desired location using locally acquired hardware. Install the console to the bracket by aligning the console mating grooves with the bracket and sliding the console onto the bracket until the snap engages.

**Figure 9**

**Standard Mounting Bracket**



### **▲ WARNING**

The console must not obstruct the view of the operator or interfere with the operation of the tractor.

### **CAUTION**

To prevent damage to the console, be sure the snap fully engages during installation.





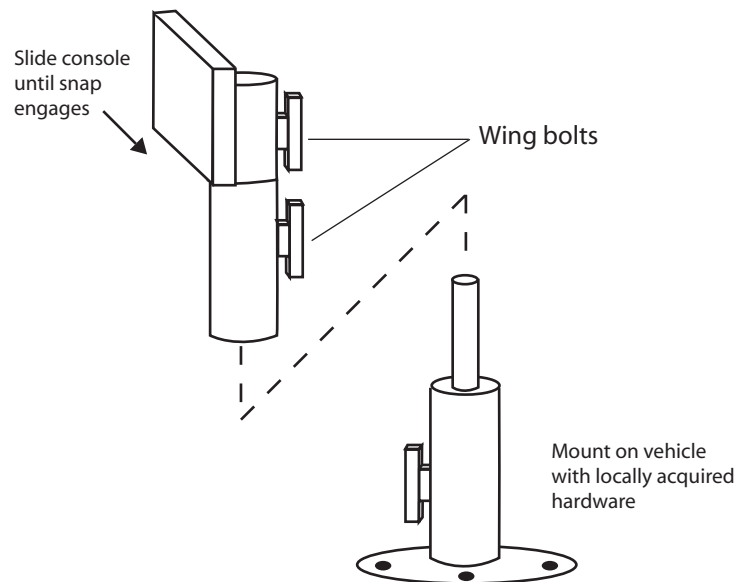
## OPTIONAL MOUNTING 3D ADJUSTABLE BRACKET

Separate the bracket halves from one another by loosening the wing bolt. Install the upper bracket half into the console by sliding the bracket's rectangular section into the console mating grooves until the snap engages. Install the bottom bracket half at the location of your choice using locally acquired hardware.

**Figure 10**

**Optional 3D Mounting Bracket**

---



---

### **⚠ WARNING**

The console must not obstruct the view of the operator or interfere with the operation of the tractor.

---

### **CAUTION**

To prevent damage to the console, be sure the snap fully engages during installation.

---

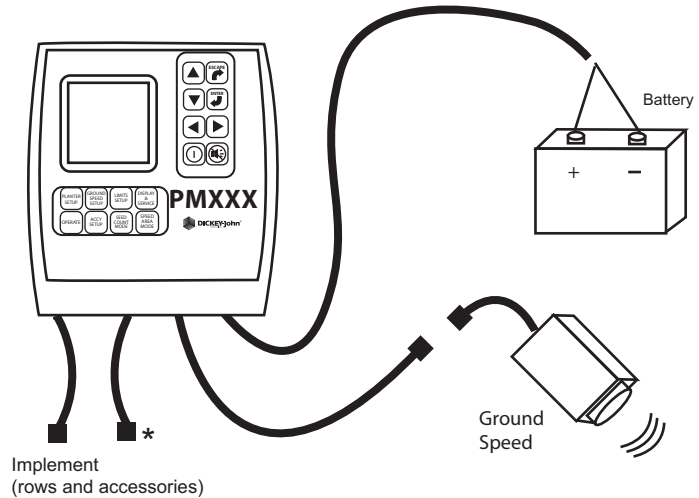


## INSTALLING CONSOLE HARNESSSES

Several harnesses are located at the bottom of the PM300, PM332, and PM400. These include power, ground speed sensor, and sensor inputs (rows, lift switch, two hopper levels, and one frequency function [shaft/fan/flow]).

**Figure 11**

### Console Harnesses



\*PM300 does not have a second cable  
PM332 has a 9 pin accessory cable  
PM400 has a 37-pin cable

1. Route the power harness to a +12 V source near the battery if possible.
2. Route the ground speed sensor harness connection to the RADAR, Hall Effect, or GPS ground speed sensor.
3. Route the implement harness to the location of choice, typically near the drawbar.

### **WARNING**

The harnesses must not obstruct movement of the operator or of the moving parts of the tractor or implement. Take care when routing harnesses to secure them at proper locations; provide slack as needed to allow for movement.

### **CAUTION**

Poor +12 V connections may cause intermittent console operation. Be sure to connect the power harness to a clean, well-conditioned source (direct battery connection is preferred).

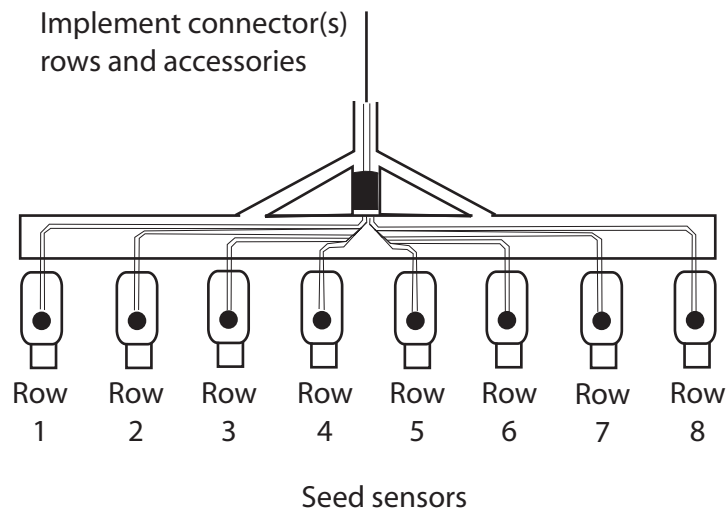


## INSTALLING IMPLEMENT HARNESS AND SENSORS

The implement harness provides custom fit and functions required by the implement. Each harness branch is labeled for location (row 1, row 2, etc.) or sensor (lift switch) for routed connection. Some sensors may require special adapters for connection.

**Figure 12**

**Implement Harness/Sensors**



1. Install sensors onto seed tubes using tie-wraps.
2. Route implement harness to the appropriate locations; provide slack near moving parts to allow for movement. Attach harness to the implement using tie-wraps.
3. Make sure the hitch connections will connect to the tractor connections with the proper amount of slack for implement movement.

### CAUTION

**The harnesses must not obstruct moving parts of the tractor or implement. Take care when routing harnesses to retain them at proper locations with adequate slack for movement.**



## ADVANCED SETUP

The monitor is designed for ease of basic monitoring by new users while supporting expanded features for advanced users. The user may decide which features to configure.

### PLANTER AND GROUND SPEED (REQUIRES DATA ENTRY)

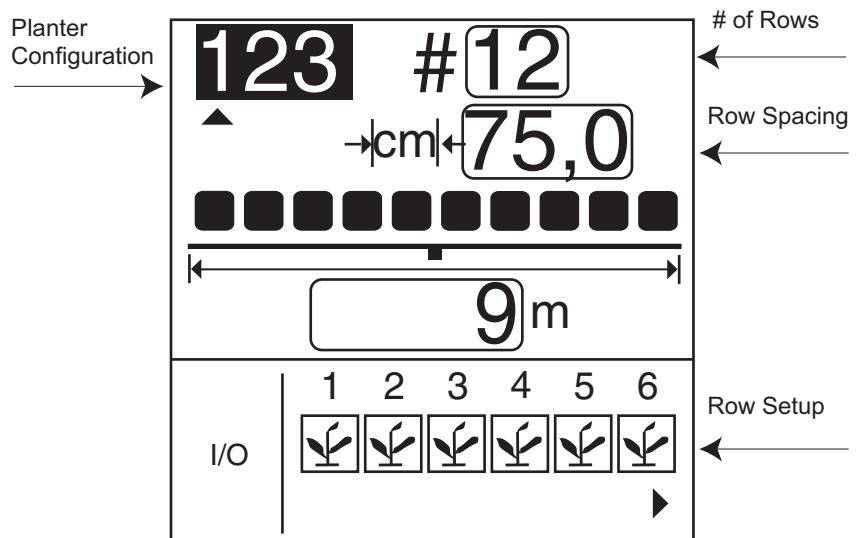
The two setup screens that require input for the system to function as a monitor are the **Planter Setup** screen (Figure 13) and the **Ground Speed Setup** screen (Figure 14).



Planter Setup key

Figure 13



Planter Setup Screen





### ROW SETUP (AUTO ASSIGNED)

The console will automatically assign the number of rows defined on the **Planter Setup** screen as ON (population rows).

Rows may be configured to ON (population), OFF (split row), FLOW (blockage), or DISABLED.

- When ON  is selected (plant), the row is active and the console will detect sensors and seed flow.
- When OFF  is selected (blank), the row is removed and remaining rows are re-numbered. This is used for split row systems where every other row or sets of internal rows are not planting. Their corresponding row number is ignored, allowing for true planting operations to be displayed on the monitor.



- When DISABLED  is selected (circle with slash), the row input is ignored. The row number will be displayed. This is used when a row or sensor is malfunctioning and the operator wants to disable monitoring on that row.
- When FLOW  is selected (funnel), the row will not be included for population calculations but will be monitored for flow. The flow rows will be used to detect flow (fertilizer or seeds) and alarm if the flow falls below two pulses per second.

The **Planter Setup** screen must include the number of rows and the row spacing or implement width for the console to properly display population. Up to three individual configurations can be programmed and supports split row planters (CONFIGURATION 1 for NORMAL and 2 for SPLIT ROW) and a separate seeder or drill (CONFIGURATION 3).

### To configure row setup:

1. Highlight the 123 (refer to Figure 13) at the upper left corner of the screen
2. Press the **Enter** key
3. Use the **Left and Right Arrow** keys to select the appropriate planter configuration.
4. Press **Enter** to accept selection.
5. Press the **Down Arrow** key to highlight the I/O icon for row setup.
6. Press the **Enter** key to select the icon and highlight the first row unit.
7. Use the **Up or Down Arrow** key to toggle through the four possible configurations: On, Off, Disabled or Flow.
8. Use the **Left or Right Arrow** key to highlight another row unit for reconfiguring.
9. Press the **Enter** key to save the selection.
10. Press **Enter** key again to select another row to change and the **Left or Right Arrow** key to move to other row units to reconfigure.
11. When finished, press **Operate** key to return to the **Operate** (main) screen.



Enter key



Left and Right Arrow keys



Up or Down Arrow keys



Ground Speed Setup key

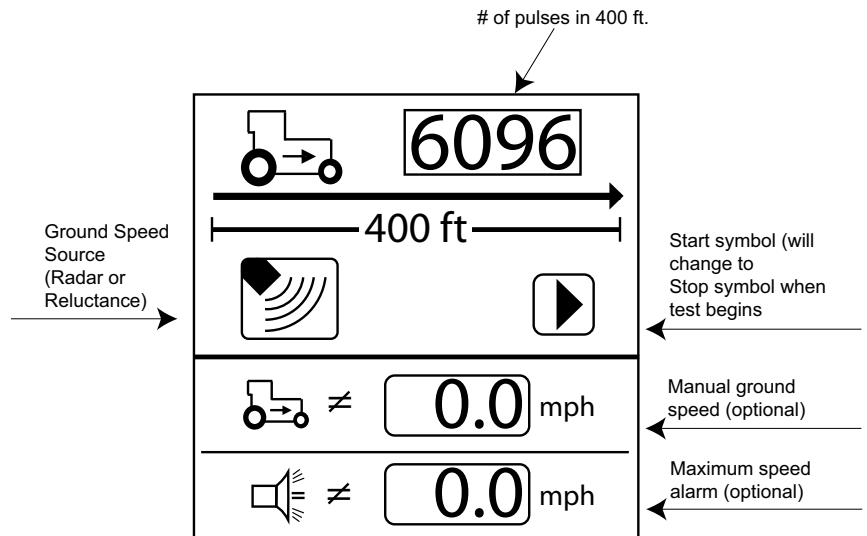
## GROUND SPEED SETUP

The **Ground Speed Setup** screen must include a calibration factor for proper calculation and display of ground speed. Also included on the **Ground Speed Setup** screen are a calibration aid, a manual ground speed value, and a maximum speed alarm. The calibration aid may be used to measure the calibration factor, which is the number of pulses in 400 ft (122 m). The manual ground speed (optional) may be used when a ground speed sensor is not installed or has failed in the field. The maximum speed alarm (optional) provides the user with an over-speed alarm.



**Figure 14**

**Ground Speed Setup Screen**



**NOTE:** To verify that the correct calibration number has been obtained, move to the **Speed Area Mode** screen. Verify that the speed matches the vehicle's speedometer or remeasure the 400-foot distance.



Up or Down Arrow keys



Enter key

## MANUAL GROUND SPEED CONSTANT ENTRY

A manual ground speed value should only be entered when the ground speed sensor or tractor radar has failed and no ground speed input is available.

**IMPORTANT:** Entering a manual ground speed value when the ground speed sensor or tractor radar is working properly and connected to the monitor will interfere with the proper operation of the planter monitor. Accumulated acreage will not be recorded.

To enter a manual ground speed value:

1. Press the Ground Speed Setup key to access the ground speed setup screen.
1. Use the **Down Arrow** key to highlight the manual ground speed value (refer to Figure 6).
2. Select the **Enter** key to modify the constant.
3. Use the **Arrow** keys to select digits, increment, and decrement values.
4. Select the **Enter** key to accept the new number.
5. Once the new values have been entered, select either the **Escape** or **Operate** key to return to the **Operate** (main) screen.

Any non-zero value will activate manual ground speed. Set manual ground speed to zero to disable.

To verify that the correct calibration number has been obtained, move to the Speed Area Mode screen.

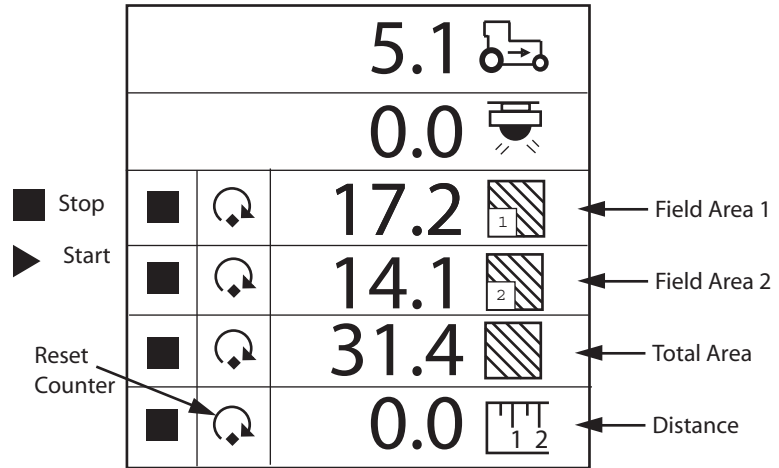
1. Press the **Speed Area Mode** key.



2. Verify that the speed matches the vehicle's speedometer or re-measure the 400-foot distance.

**Figure 15**

**Speed Area Mode Screen**



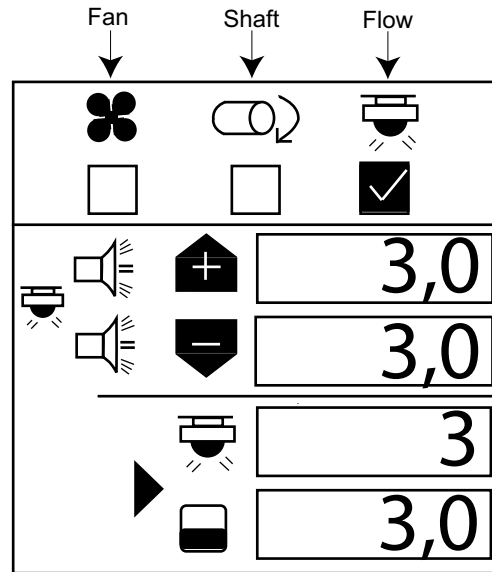
## ACCESSORY SETUP (OPTIONAL)

To add an auxiliary sensor and its performance characteristics (calibration values, limits, etc.) to the monitoring inputs, it must be activated by entering a calibration constant. If minimum or maximum alarms are desired, the limits may be added to the calibrated sensors. A fan, shaft, or flow sensor may be monitored with HI and/or LOW alarms or no alarm values. Refer to Figure 16.





**Figure 16**  
**Accessory Screen**



Left and Right Arrow keys



Enter key



Start symbol



Stop symbol

**To enter a calibration constant:**

1. Press **Accessory Setup** key.
2. Use the **Left and Right** key to select fan, shaft or flow symbol.
3. Use the **Down Arrow** key to change high and low alarm values.
4. Press **Enter** to Highlight digit to change. If the calibration factor is unknown, the monitor can determine the calibration factor by using the built-in calibration mode.

**⚠ WARNING**

**Assure equipment is configured to be operated safely. Shaft/fan calibration requires movement in associated equipment and revolution counting. Flow calibration requires liquid dispensing, catching, and measurement.**

To perform a sensor calibration, highlight the **Start** symbol. Assure the system is in a safe state. Start the monitor calibration by selecting the **Enter** key. The **Start** symbol (triangle) will change to a **Stop** symbol (square). Activate the shaft, fan, or flow. Count the revolutions (shaft/fan) or catch liquid (flow) while the monitor measures pulses. Deactivate the shaft, fan, or flow. Stop the monitor calibration by selecting the **Enter** key again. Highlight the revolutions or liquid level window. Select the **Enter** key. Enter the number of revolutions (shaft/fan) or gallons (flow).



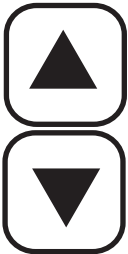
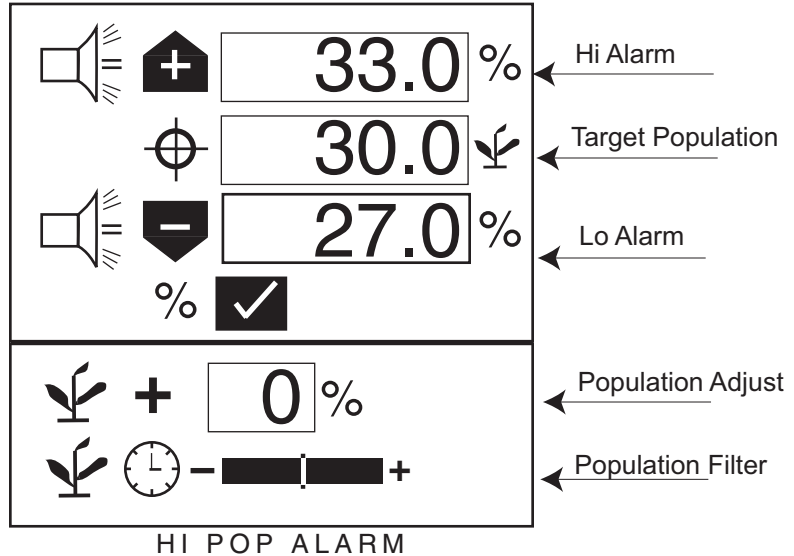


## LIMITS SETUP (POPULATION) (OPTIONAL)

The **Limits Setup** screen allows users to define several population features (refer to Figure 17). Users may define a target population, a minimum or under population alarm limit, a maximum or over population alarm limit, a population adjustment factor, and a population response rate.

Figure 17

Limits Setup Screen



Up or Down Arrow keys



Left and Right Arrow keys



Enter key

### TARGET POPULATION

Target population is defined in 1000s of seeds per acre or hectare, dependent on the unit of measurement selected. If no value is entered, the monitor uses average population to calculate alarms or row population indicators.

With the limits set up screen displayed as shown in Figure 17:

1. Use the **Down Arrow** key to highlight the target population field.
2. Press the **Enter** key to highlight field.
3. Use the **Left or Right Arrow** key to select a digit for editing.
4. When a digit is highlighted, use the **Up or Down Arrow** keys to edit the value displayed.
5. When the field shows the desired target population, press the **Enter** key to confirm the selection.
6. Select either the **Escape** or **Operate** key to return to the **Operate** (main) screen.

If no value is entered, the monitor uses average population to calculate alarms or row population indicators.



*Up or Down Arrow keys*



*Enter key*



*Left and Right Arrow keys*

## HI POPULATION/LOW POPULATION

The Hi population and Low population values determine when an alarm or row indicator displays to warn the operator about a population problem. If the percentage (%) box is checked, the values are percentage based. For example, 10% of 30,000 seeds/acre for the over population setting (33,000 seeds/acre) and for the under population setting (27,000 seeds/acre) (refer to Figure 17). If the percentage (%) box is not checked, the values are population based and expressed in 1000s of seeds per acre or hectare. The over population and under population values are independent of each other and do not have to be the same percentage value.

### To change the percentage (%) box setting,

1. Use the **Up or Down Arrow** key to highlight the percentage (%) box.
2. Press the **Enter** key to toggle the setting from checked to unchecked.

### To change the population value settings:

1. Use the **Up or Down Arrow** key to highlight the hi alarm or low alarm field.
2. Press the **Enter** key to highlight the field for editing.
3. Use the **Left or Right Arrow** key to select a digit for editing.
4. When a digit is highlighted, use the **Up or Down Arrow** keys to edit the value displayed.
5. Press **Enter** key to confirm the selection.
6. Press the **Operate** key to return to the **Operate** (main) screen.

## POPULATION ADJUSTMENT

A population adjustment provides a means to display populations nearer the actual versus the sensed seeding rates. This is useful when sensors do not detect doubles, triples, etc.

### To change the over population value setting:

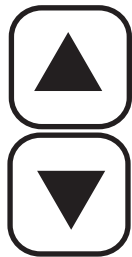
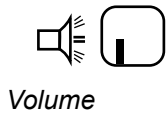
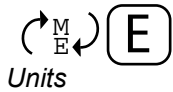
1. Use the **Up or Down Arrow** key to highlight the field.
2. Press the **Enter** key to highlight the field for editing.
3. Use the **Left or Right Arrow** key to select a digit for editing.
4. When a digit is highlighted, use the **Up or Down Arrow** keys to edit the value displayed.
5. Press **Enter** key to confirm the selection.
6. Press the **Operate** key to return to the Operate (main) screen.

## POPULATION RESPONSE RATE

The population response rate is used to provide population display stability for planters with few rows versus many or when the sensed application rate does not match the actual application rate. Use the Population Filter to stabilize population and alarm reporting.

### To change population response rate:

1. Move the slide to the right when planting high seed rates and to the left when planting low seed rates. (refer to Figure 17).
2. Press the **Operate** key to return to the **Operate** (main) screen.

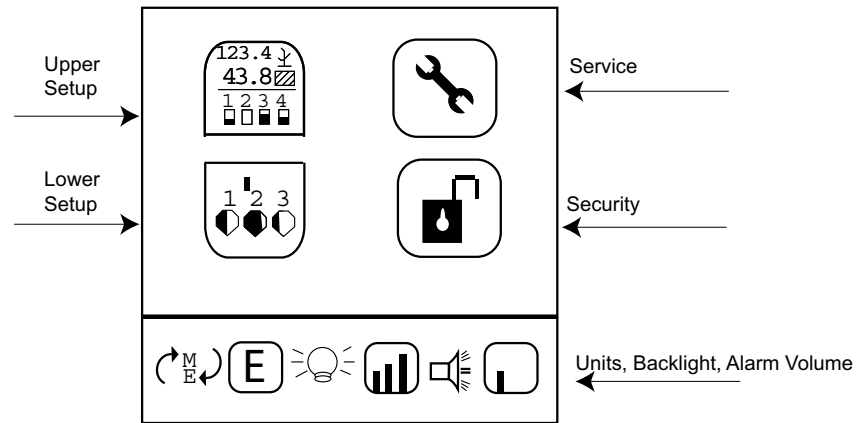


## UNITS OF MEASUREMENT, BACKLIGHTING AND ALARM VOLUME CONTROL

The display screen can be customized by changing the units of measurement to English or Metric, control backlight intensity and increase or decrease alarm volume.

**Figure 18**

**Display & Service Screen**



### To change Units, Backlight, and Alarm Volume:

1. Press **Display & Service** key.
2. Press the **Down Arrow** key to highlight **Units, Backlight or Alarm Volume** icon.
3. Press **Enter** to highlight the setting to change and the **Up and Down Arrow** key to cycle through selection.
4. Press **Enter** to confirm the desired selection.

## SERVICE SCREEN

The service screen provides information about the monitor's software and hardware versions, total hours of operation, total acres covered, battery voltage, hopper level 1 and 2 sensor status, and lift switch status. (refer to Figure 19).

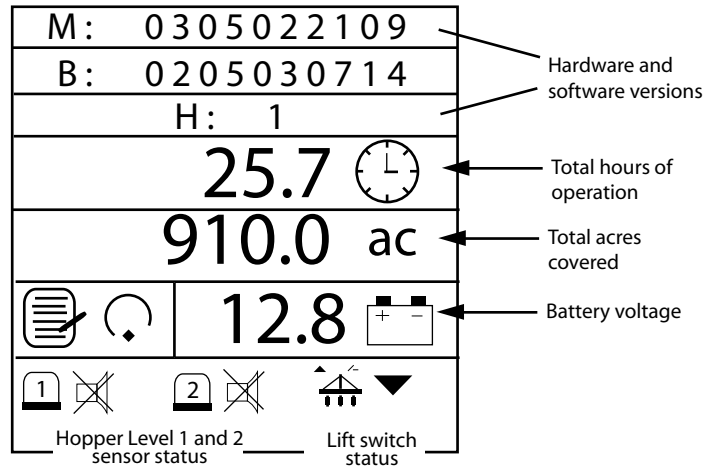
### To display the service screen:

1. Press the **Display & Service** key.
2. Highlight the Service icon and press **Enter**.



**Figure 19**

**Service Screen**



*Up or Down Arrow keys*



*Security icon*



*Enter key*



*Escape key*

## SECURITY SCREEN

Security features allow password protection security levels to be activated (refer to Figure 20). This prevents unauthorized personnel from modifying key parameters in the field.

The password screen allows the operator to individually lock screens to assure they are not modified.

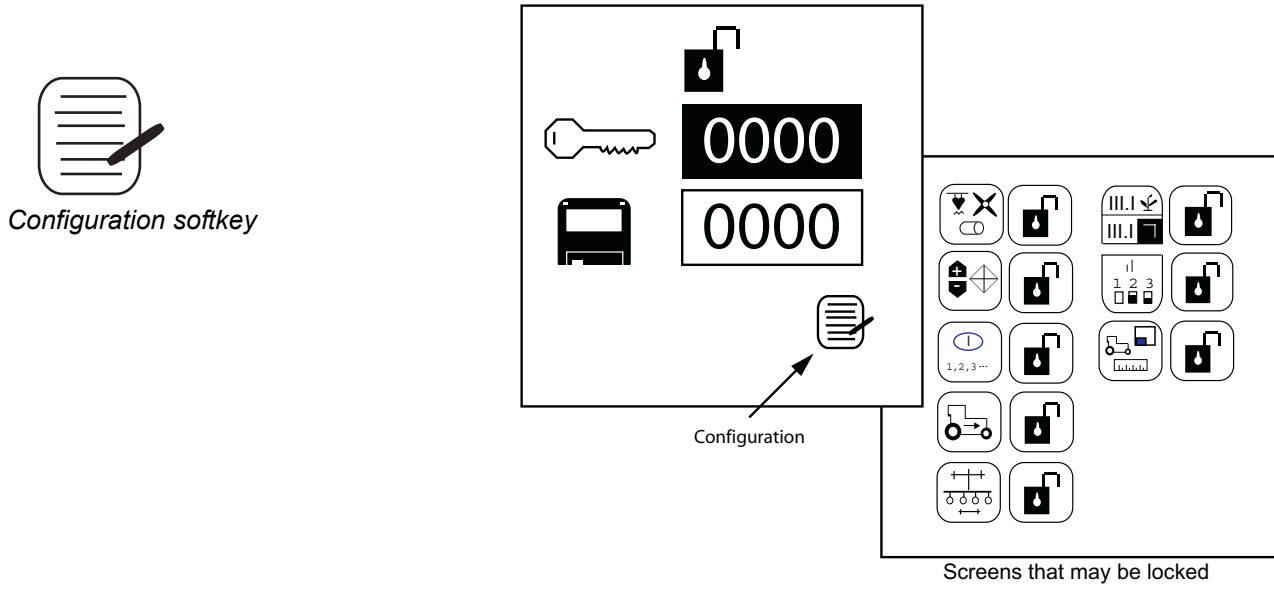
### To Lock and Unlock Screens:

1. Press the Display & Service key.
2. Using the **Arrow** keys, highlight the **Security** icon and press the **Enter** key to enter a password.
3. Modify the digits and select the **Enter** key again to accept the password.
4. Highlight the **Configuration** key and press **Enter** to navigate to the list of screens.
5. Use the Up or Down Arrow key to highlight icon for editing.
6. Press Enter to select the Lock/Unlock icon.
7. Lock or unlock screens by pressing the **Up or Down Arrow** keys.
8. Press **Enter** key to accept Lock or Unlock.
9. Select the **Escape** key to return to the **Password** screen.
10. Highlight the padlock and select the **Enter** key to toggle the unlocked state to locked. The selected screens will require input of the password prior to modification.



**Figure 20**

**Security Screen and Screens That May Be Locked**





## AUXILIARY MODES

*NOTE: Alarms are disabled in these modes.*

*NOTE: A lift switch may be used to more accurately monitor acre accumulators and is required for acreage monitoring in non-planting operations.*

*If a manual ground speed is selected, the area and distance will not accumulate in this mode.*



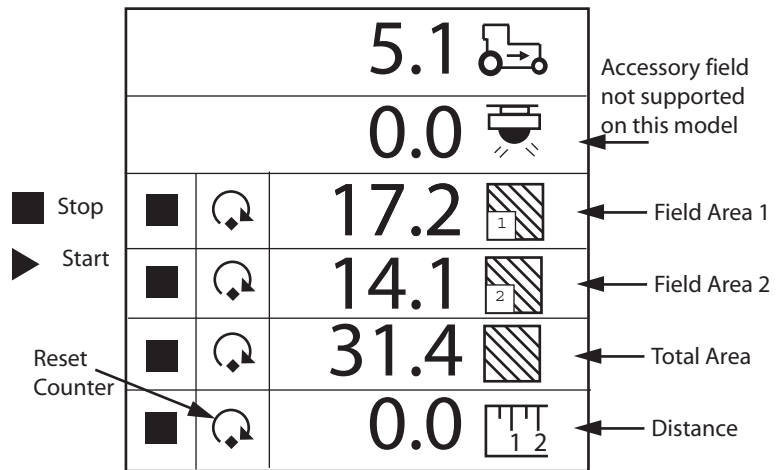
The monitors provide modes for alternate monitor use and row unit testing.

### SPEED AREA MODE

The SPEED AREA mode is used for cultivating (Figure 21). This mode includes start/stop/reset for Field Area 1, Field Area 2, Total Area (hc3/ac3), and distance.

**Figure 21**

**Speed Area Mode**



### SEED COUNT MODE


The SEED COUNT mode is used to determine row unit performance when operating in a stationary manner. A reset for all rows is included (refer to Figure 22).



**Figure 22**

**Seed Counting Mode**

---

		← Reset option	
1	<input type="text" value="9,521"/>	10	<input type="text" value="9,521"/>
2	<input type="text" value="9,521"/>	11	<input type="text" value="9,521"/>
3	<input type="text" value="9,521"/>	12	<input type="text" value="9,521"/>
4	<input type="text" value="9,521"/>	13	<input type="text" value="9,521"/>
5	<input type="text" value="9,521"/>	14	<input type="text" value="9,521"/>
6	<input type="text" value="9,521"/>	15	<input type="text" value="9,521"/>
7	<input type="text" value="9,521"/>	16	<input type="text" value="9,521"/>
8	<input type="text" value="9,521"/>	17	<input type="text" value="9,521"/>
9	<input type="text" value="9,521"/>	18	<input type="text" value="9,521"/>



## MONITORING PLANTING

### OPERATE SCREEN SETUP

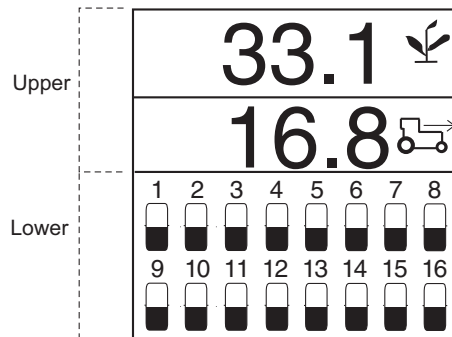
The Operate (main) screen provides many tools for monitoring planting. This screen can be immediately accessed from any other screen or sub-menu by pressing the **Operate** key.

The Operate screen is divided into the upper parameter window and the lower parameter window. The operator can customize the layout and content of both windows, but the size of the individual windows is fixed. (refer to Figure 23).



**Figure 23**

**Operate Screen**



### CUSTOMIZING THE UPPER PARAMETER WINDOW

The Operate (Main) screen may be customized by changing the number of parameter lines to display in the upper window, the icon selected as text or graphic, and the planting parameter reported for each line.

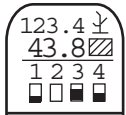
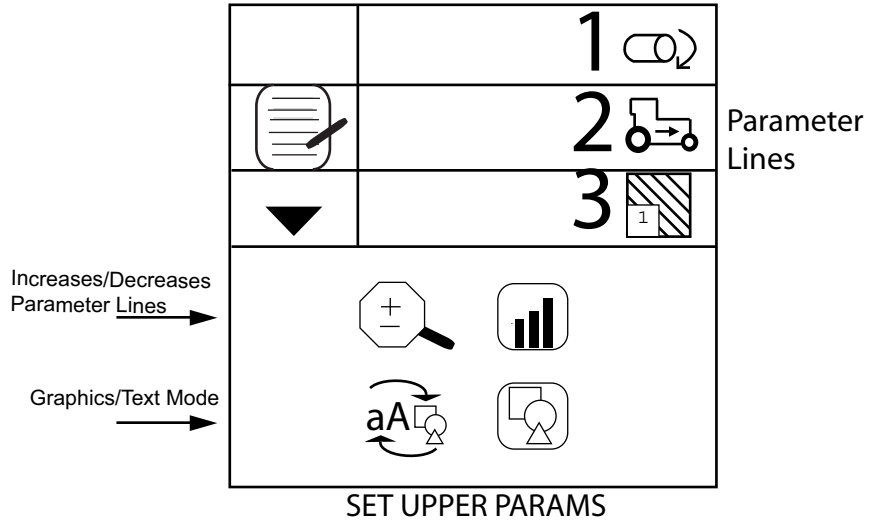
An example of five parameters selected:

- 1 = Average population
- 2 = Speed
- 3 = Field area
- 4 = Total area
- 5 = Shaft RPM





**Figure 24**  
**Upper Parameters Screen**



*Upper Parameter icon*



*Enter key*



*Up or Down Arrow key*

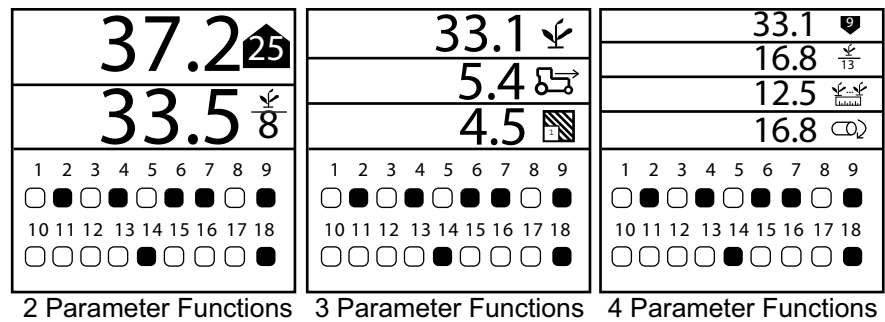
### Changing Number of Parameters

The parameter lines display can be configured to show 2, 3, or 4 parameters at one time by changing the size of the parameters. The **Up and Down Arrow** keys are used at the Operate screen to scroll down to see all parameters being monitored.

#### To Change the Number of Parameter Lines:

1. Press the **Display & Service** key with the **Upper Parameter** icon highlighted.
2. Press the **Enter** key.
3. Press the **Down Arrow** key to highlight the magnifying glass.
4. Press **Enter** key to select the icon. Use the **Up or Down Arrow** key to toggle through the options for 2, 3 or 4 display lines.
5. Press **Enter** to confirm the selection.

**Figure 25**  
**Parameter Line Options**



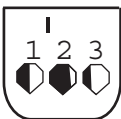


Parameters may be selected to display in numerical order from the following list. (refer to MONITORING FUNCTIONS p. 39 for additional information).

- Average Population
- Average Seed Spacing
- Average Seeds Per Distance
- Population Row Scan
- Seed Spacing Row Scan
- Seed Per Distance Row Scan
- Minimum, Maximum, Average Row Population
- Minimum, Maximum, Average Row Spacing
- Minimum, Maximum, Average Spacing Per Distance
- Field Area 1
- Field Area 2
- Total Area 3
- Ground Speed
- Fan, Shaft, or Flow Frequency



Enter key



Lower Parameter icon



Up and Down Arrow keys

## Changing Graphic or Text Icons

The planting parameters display can be configured for text or graphic icons in the upper window.

### To Change the Graphic/Text Settings:

1. Press the **Display & Service** key with the **Upper parameter** icon highlighted.
2. Press the **Enter** key.
3. Use the **Down Arrow** key to highlight the Graphic/Text icon.
4. Press **Enter** key to select the icon. Use the **Up or Down Arrow** key to toggle to desired setting.
5. Press **Enter** to confirm selection.

## CUSTOMIZING THE LOWER PARAMETER WINDOW

The lower setup screen parameters can be modified to change the row indicator type and size. Row indicator types include blinking box (blink rate proportional to seeding rate), solid box (indicating row failure), bar graph, or wiper gauge.

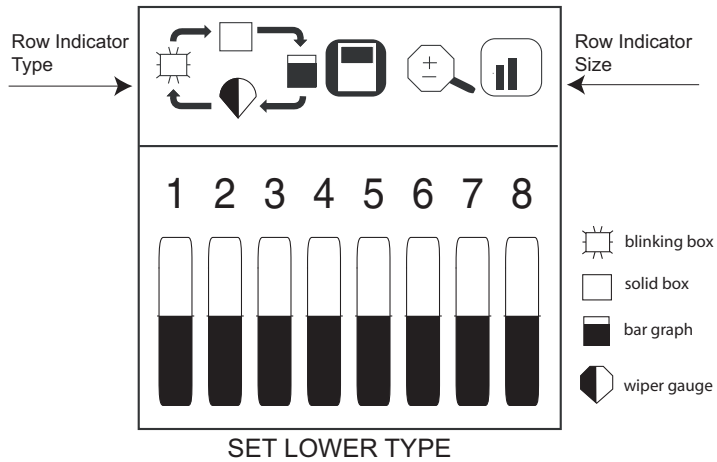
### To Change the Row Indicator Type and Row Indicator Size:

1. Press the Display & Service key with the **Lower Parameter** row indicator icon highlighted.
2. Press **Enter** to display the lower setup screen.
3. Highlight the Row Indicator Type or Row Indicator Size icon to change.
4. Press the **Up or Down Arrow** key to cycle through desired setting.
5. Press **Enter** to accept selection.



Figure 26

Lower Parameters Screen

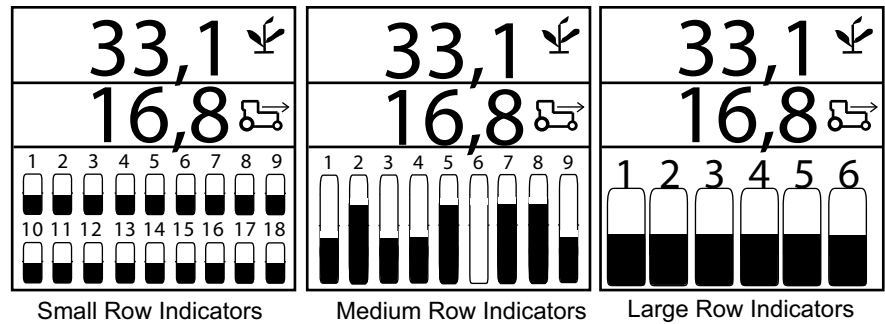


Row indicator size determines the number of rows displayed on the bottom half of the screen and may be displayed in a small, medium, or large size as shown in Figure 27. Default setting is non-blinking box, medium size.

When more rows are configured ON than are viewable, the monitor automatically scrolls through the rows at 5 second intervals (bar graph with 36-row machine). The operator may use the **Right** and **Left Arrow** keys to manually select the desired rows. Automatic scrolling will restart 10 seconds after a manual selection.

Figure 27

Row Indicator Size



AVAILABLE PLANTING PARAMETERS

AVERAGE POPULATION



Average Population

**Average Population** displays the average of the planter's rows that are configured for population in thousands of seeds per acre (s/ac) or thousands of seeds per hectare (s/ha). The population response rate and population adjustment may be modified on the target set-up screen. This function may be labeled with a symbol or text, depending on the text/graphic setting.



*Minimum/Average/Maximum Population*



*Population Row Scan*



*Average Spacing*



*Minimum/Average/Maximum Spacing*



*Spacing Row Scan*



*Seeds Per Distance*



*Minimum/Average/Maximum Seeds Per Distance*



*Seeds Per Distance Row Scan*

## MINIMUM/AVERAGE/MAXIMUM POPULATION

**Minimum/Average/Maximum Population** alternates the display of the minimum row, planter average, and maximum row every two seconds. When a minimum or maximum row is displayed, the corresponding symbol is shown with the row number.

## POPULATION ROW SCAN

**Population Row Scan** displays the population of each of the planter's rows. The displayed row is incremented every two seconds. After the last row is displayed, the scan will resequence beginning with the first active row.

## AVERAGE SPACING

**Average Spacing** displays the average seed spacing (inches or cm) of the planter's rows that are configured for population. This function may be labeled with a symbol or text, depending on the text/graphic setting.

## MINIMUM/AVERAGE/MAXIMUM SPACING

**Minimum/Average/Maximum Spacing** alternates the display of the minimum row, planter average, and maximum row every two seconds. When a minimum or maximum row is displayed, the corresponding symbol is shown with the row number.

## SPACING ROW SCAN

**Spacing Row Scan** displays the spacing of each of the planter's rows. The displayed row is incremented every two seconds. After the last row is displayed, the scan will resequence beginning with the first active row.

## SEEDS PER DISTANCE

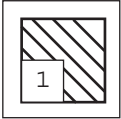
**Average Seeds Per Distance** displays the average seeds per foot (s/ft) or seeds per meter (s/m) of the planter's rows that are configured for population. This function may be labeled with a symbol or text, depending on the text/graphic setting.

## MINIMUM/AVERAGE/MAXIMUM SEEDS PER DISTANCE

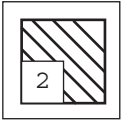
**Minimum/Average/Maximum Seeds Per Distance** alternates the display of the minimum row, planter average, and maximum row every two seconds. When a minimum or maximum row is being displayed, the corresponding symbol is shown with the row number.

## SEEDS PER DISTANCE ROW SCAN

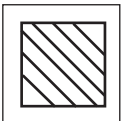
**Seeds Per Distance Row Scan** displays the seeds per distance of each of the planter's rows. The displayed row is incremented every two seconds. After the last row is displayed, the scan will resequence beginning with the first active row.



*Field Area 1*



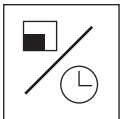
*Field Area 2*



*Total Area*



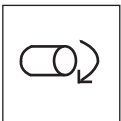
*Speed*



*Area Per Hour*



*Fan*



*Shaft*



*Flow*

## FIELD AREA 1

**Field Area 1** (ac1/ha1) displays the area of Field 1 in acres (ac) or hectares (ha) depending on the English/Metric setting. This function may be labeled with a symbol or text, depending on the text/graphic setting.

## FIELD AREA 2

**Field Area 2** (ac2/ha2) displays the area of Field 2 in acres (ac) or hectares (ha) depending on the English/Metric setting. This function may be labeled with a symbol or text, depending on the text/graphic setting.

## TOTAL AREA

**Total Area** (ac3/ha3) displays the total field area in acres (ac) or hectares (ha) depending on the English/Metric setting. This function may be labeled with a symbol or text, depending on the text/graphic setting.

## SPEED

**Speed** displays vehicle speed in miles per hour (MPH) or kilometers per hour (km/h) depending on the English/Metric setting. This function may be labeled with a symbol or text, depending on the text/graphic setting.

## AREA PER HOUR

**Area Per Hour** displays the current rate of area per hour in acres per hour (ac/hr) or hectares per hour (ha/hr) depending on the English/Metric setting.

## FAN

**Fan** displays the fan's speed in revolutions per minute (RPM).

## SHAFT

**Shaft** function displays the shaft's speed in revolutions per minute (RPM).

## FLOW

**Flow** displays the flow rate speed in gallons per acre (g/ac) or liters per hectare (l/ha) depending on the English/Metric setting.



## ALARMS

**NOTE:** An audible 2-chirp alarm is also output during navigation or data entry to indicate an illegal or nonfunctional key selection.

Primary operating alarms are displayed on the entire screen and are accompanied by an audible alarm.

All monitor alarms are set to a default of Zero (0) and will not activate unless programmed per the Advanced Setup section.

## HOPPER LEVEL

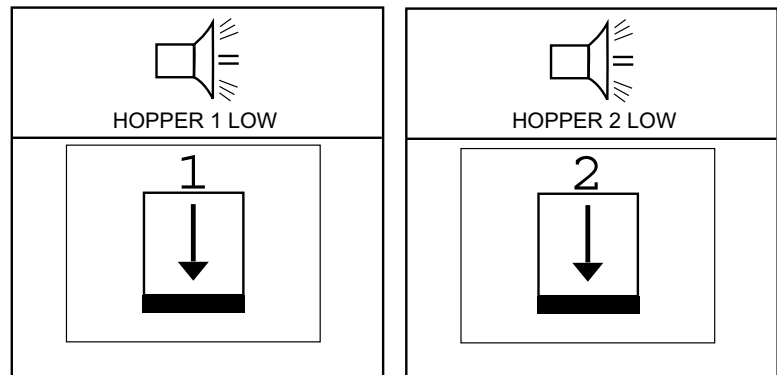
Hopper level alarms activate when the seed level drops below the sensor mounting level (refer to figure 28). Alarm can be silenced by pressing the **Alarm Cancel** key.



Alarm Cancel key

**Figure 28**

**Hopper 1 And 2 Alarms**



## ROW FAILURE

A row failure alarm occurs when the console detects less than 2 seeds per second through the seed tube. This may result from a poor or faulty connection to the seed sensor harness. This is a solid on alarm indicating a problem has been detected and is silenced by pressing the **Alarm Cancel** key as shown in Figure 29.

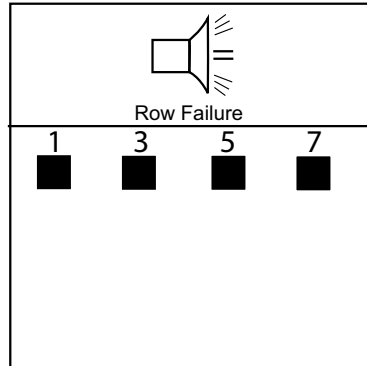
Once the **Alarm Cancel** key is pressed, the alarm will not sound again unless:

1. Planting condition returns to a normal state and falls again below 2 seeds per second.
2. Power on/off sequence occurs before problem is corrected.
3. An All Rows Failure alarm occurs then the console again detects less than 2 seeds per second through the seed tube.



**Figure 29**

**Row Failure Display**



## ALL ROWS FAILURE

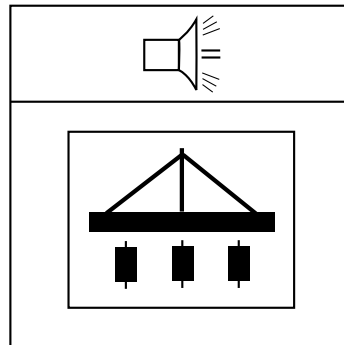
An All Row Failure alarm is a unique alarm identifier (8 chirps) that differentiates from all other alarms and triggers when no seed flow is detected from any row unit when ground speed is detected.

Typical scenarios to activate an All Row Failure alarm:

1. Tractor is stopped while planter is in the ground.
2. Tractor is operating with planter lifted.
3. Normal "end of run" turn around.

**Figure 30**

**All Rows Failure Display**



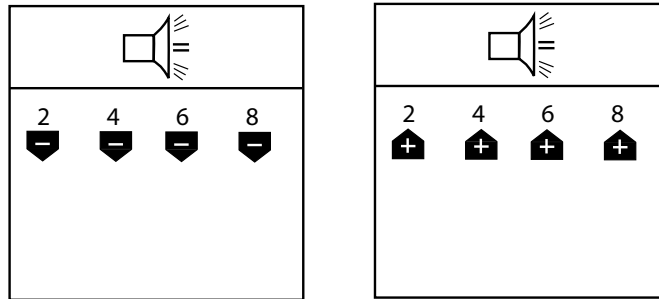


## HI/LOW POPULATION WARNING

The Hi and Low population alarm triggers when seed flow drops below the population alarm limit set on the Limits Setup screen. The alarm display will beep and flash on the screen briefly indicating row units are over or under the desired population (refer to Figure 31). The Operate (Main) screen will display the row unit over or under population symbol until recorrected, All Rows Failure occurs, or sensor mechanical problems are fixed.

**Figure 31**

*Population Limit Warning Display*

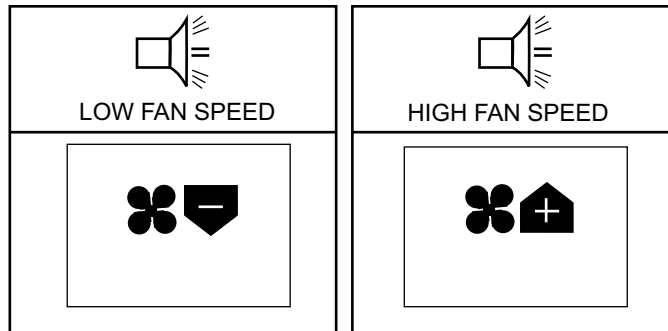


## FAN SPEED LO/HI LIMIT WARNING

Fan speed alarms are triggered with a solid-on alarm when any fan speed exceeds or falls below the value entered for Fan Speed Lo/Hi Limits in the Setup mode (Refer to Figure 32). Alarm can be silenced by pressing **Alarm Cancel** key, but will re-activate if problem is not resolved.

**Figure 32**

*Fan Speed Limit Warning Display (Optional)*





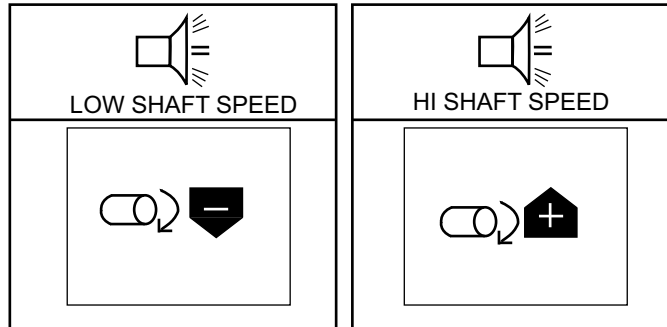


## SHAFT SPEED LOW/HI LIMIT WARNING

Alarm sounds when any shaft speed exceeds or falls below the value entered for Shaft Speed Lo or Hi Limits in the Setup mode (Refer to Figure 33). Alarm can be silenced by pressing **Alarm Cancel** key, but will re-activate if problem is not resolved.

**Figure 33**

**Shaft Speed Limit Warning Display (Optional)**

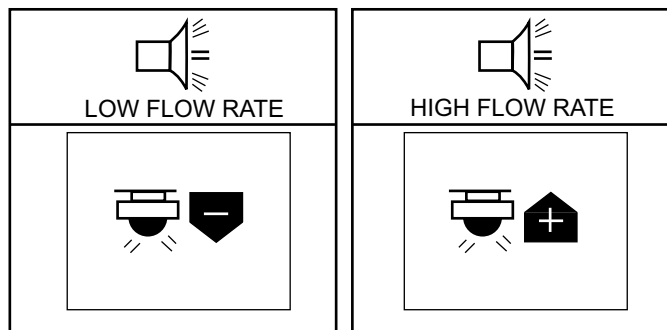


## FLOW LOW/HI LIMIT WARNING

An alarm will sound when flow inputs exceed or fall below the value entered for the Flow Lo or Hi Limits in the Setup mode. (Refer to Figure 34). Alarm can be silenced by pressing **Alarm Cancel** key, but will re-activate if problem is not resolved.

**Figure 34**

**Flow Low/ Hi Limit Warning Display (Optional)**



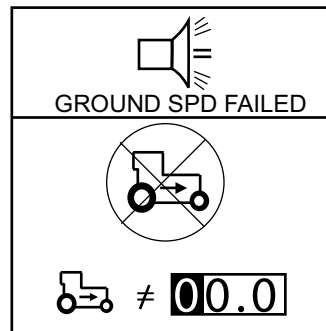


## FAILED GROUND SPEED SENSOR (PLANTING DETECTED WITHOUT GROUND SPEED)

The failed ground speed sensor alarm triggers when planting is detected with no ground speed being reported. This may result from a poor or faulty connection to the speed sensor or from a defective sensor. This is a 4-chirp alarm which is acknowledged by pressing the **Alarm Cancel** key, but will re-activate until the problem is corrected.

**Figure 35**

**Ground Speed Sensor Failure Display**

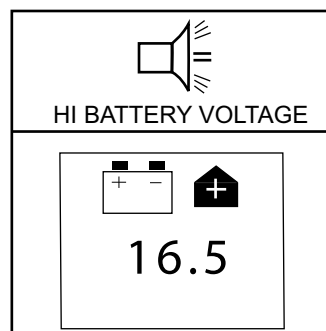


## BATTERY HI/LOW

The battery hi/low alarm triggers when battery voltage is out of range - over voltage and under voltage. The correct power operating range is 10-16 VDC. Alarm indicates an electrical problem exists that must be corrected. The alarm cannot be shut off and will continue to sound until corrective action is taken.

**Figure 36**

**Battery Failure Display**



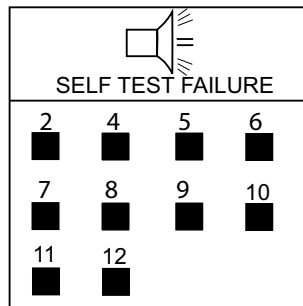


## SELF-TEST FAILURE

The Self Test Failure alarm activates at every power cycle comparing configured number of rows to number of rows detected. Any sensor not found during self-test or inaccurate configuration will sound alarm and display on the Operate (main) screen. The alarm can be acknowledged by pressing the **Alarm Cancel** key, but will re-activate until problem is resolved.

**Figure 37**

### *Self Test Failure*

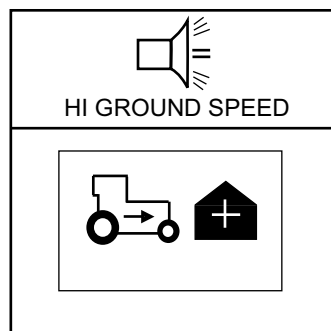


## HI GROUND SPEED EXCEEDED (OPTIONAL)

The Hi Ground Speed Exceeded alarm is triggered anytime the speed has exceeded the mph input in the Ground Speed Setup screen. Alarm can be silenced by pressing the **Alarm Cancel** key.

**Figure 38**

### *Maximum Speed Exceeded Warning Display (Optional)*





## TROUBLESHOOTING

### MONITOR WILL NOT POWER ON

#### Probable Cause

1. Blown console fuse
2. Poor battery connection
3. Low battery voltage
4. Defective console

#### Corrective Action

1. Check fuse (located near battery connection). If needed, replace with 5.0 A fuse maximum. If fuse blows again, check all harnesses for pinches or breaks that may cause power short to ground.
2. Be sure connections are clean and tight. Inspect harness for damage.
3. Console voltage must be at least 10 V. If low, recharge or replace battery.
4. Console is damaged. Contact your dealer, DICKEY-john USA (1-800-637-3302) or DICKEY-john Europe (011-33-141-192189).

### ROW FAILURE OR HI/LOW ALARM WHEN ROW IS PLANTING PROPERLY

#### Probable Cause

1. Seed sensor coated with dirt
2. Faulty sensor or harness
3. Defective console

#### Corrective Action

1. Clean sensor using a dry bottle brush.
2. Drop seed down the seed tube or place a dry bottle brush down the seed tube to trigger sensor. Observe if troubleshooting sensor LED mounted to the tube blinks. If sensor does not blink, replace the sensor. If the sensor LED blinks, check harness for damage or pinched wires. If the sensor does not have an LED, swap harness connection with adjacent sensor to determine if sensor is damaged.
3. Console is damaged. Contact your dealer, DICKEY-john USA (1-800-637-3302) or DICKEY-john Europe (011-33-141-192189).



## HOPPER ALARM DOES NOT SOUND WHEN HOPPER IS EMPTY

### **Probable Cause**

1. Hopper sensor coated with dirt
2. Faulty sensor or harness shorted to ground
3. Defective console

### **Corrective Action**

1. Clean sensor using a dry bottle brush.
2. Swap harness connection with another sensor to determine if sensor or harness is damaged. Use service screen if another sensor is not available. Replace sensor or repair harness.
3. Console is damaged. Contact your dealer, DICKEY-john USA (1-800-637-3302) or DICKEY-john Europe (011-33-141-192189).

## HOPPER ALARM SOUNDS WHEN HOPPER IS FULL

### **Probable Cause**

1. Faulty sensor or harness open
2. Defective console

### **Corrective Action**

1. Swap harness connection with another sensor to determine if sensor or harness is damaged. Use service screen if another sensor is not available. Replace sensor or repair harness.
2. Console is damaged. Contact your dealer, DICKEY-john USA (1-800-637-3302) or DICKEY-john Europe (011-33-141-192189).

## SYSTEM VOLTAGE ALARM

### **Probable Cause**

1. Low battery voltage
2. Poor battery connection
3. Damaged harness

### **Corrective Action**

1. Console voltage must be at least 10 V. If low, recharge or replace battery.
2. Be sure connections are clean and tight. Inspect harness for damage.
3. Check all harnesses for pinches or breaks that may cause power or 8 V-sensor power short to ground.



## ACCESSORY ALARM SOUNDS WHEN SHAFT, FAN, OR FLOW IS WORKING

### Probable Cause

1. Sensor failure
2. Wrong calibration number
3. Incorrect limits
4. Defective console

### Corrective Action

1. Shaft, fan, or flow sensor not operating. Replace defective sensors.
2. Sensor calibration number is incorrect. Check calibration number in accessory setup screen.
3. Sensor limits are incorrect. Check limits in accessory setup screen.
4. Console is damaged. Contact your dealer, DICKEY-john USA (1-800-637-3302) or DICKEY-john Europe (011-33-141-192189).

## GROUND SPEED ALARM SOUNDS WITH FORWARD MOVEMENT

### Probable Cause

1. Ground speed sensor failure
2. Console failure

### Corrective Action

1. No ground speed sensor is detected, or planting is detected on at least one row with no ground speed. Replace faulty ground speed sensor.
2. Console is damaged. Contact your dealer, DICKEY-john USA (1-800-637-3302) or DICKEY-john Europe (011-33-141-192189).

## GROUND SPEED HIGH ALARM SOUNDS

### Probable Cause

1. Ground speed alarm set too low
2. Incorrect ground speed constant

### Corrective Action

1. Set ground speed alarm limit higher or to zero to disable.
2. Ground speed sensor has not been calibrated, RADAR sensor angle has changed, or incorrect sensor constant is entered. Use SPEED, AREA, DISTANCE mode to determine if speed is correct. If incorrect, recalibrate speed constant (**Speed Setup** screen).



## SELF-TEST ALARM

### **Probable Cause**

1. Faulty sensor or harness
2. Console failure

### **Corrective Action**

1. Trigger sensor and observe troubleshooting LED. If sensor does not have LED, swap harness connection with adjacent sensor to determine if sensor or harness is damaged. Replace sensor or harness.
2. Console is damaged. Contact your dealer, DICKEY-john USA (1-800-637-3302) or DICKEY-john Europe (011-33-141-192189).

# OPERATOR'S MANUAL



## CONNECTOR PIN-OUTS

Battery	
Pin Label	Description
Red Wire	Battery +12V
Black Wire	Battery Ground

PM300 Implement	
Pin #	Description
1	Row 1 (green)
2	Row 2 (brown)
3	Row 3 (blue)
4	Row 4 (orange)
5	Row 5 (yellow)
6	Row 6 (violet)
7	Row 7 (gray)
8	Row 8 (pink)
9	Row 9 (tan)
10	Row 10 (white/black)
11	Row 11 (red/black)
12	Row 12 (green/black)
13	Row 13 (orange/black)
14	Row 14 (blue/black)
15	Row 15 (black/white)
16	Row 16 (red/white)
17-23	No connection
24	8 V sensor power (red)
25	8 V sensor power (red/black/white)
26	Sensor return (black)
27	Sensor return (white/black/red)
28	No connection
29	Hopper 1 (green/white)
30	Hopper 2 (blue/white)
31	Shaft/Fan/Flow (black/red)
32	8 V power (red)
33	12 V switched power (white/red)
34	12 V return (black)
35	RS-232 Rx (blue/red)
36	RS-232 Tx (red/green)
37	Lift switch (orange/red)

Ground Speed	
Pin #	Description
1	Ground (black)
2	Signal (green)
3	Power (red)
4	Sense (white)

PM332 Implement	
Pin #	Description
1	Row 1 (green)
2	Row 2 (brown)
3	Row 3 (blue)
4	Row 4 (orange)
5	Row 5 (yellow)
6	Row 6 (violet)
7	Row 7 (gray)
8	Row 8 (pink)
9	Row 9 (tan)
10	Row 10 (white/black)
11	Row 11 (red/black)
12	Row 12 (green/black)
13	Row 13 (orange/black)
14	Row 14 (blue/black)
15	Row 15 (black/white)
16	Row 16 (red/white)
17	Row 17 (green/white)
18	Row 18 (blue/white)
19	Row 19 (black/red)
20	Row 20 (white/red)
21	Row 21 (orange/red)
22	Row 22 (blue/red)
23	Row 23 (red/green)
24	+8 V Snsr Pwr Left (red)
25	+8 V Snsr Pwr Right (red/blk/white)
26	Ground Left (black)
27	Ground Right (white/black/red)
28	Row 24 (orange)
29	Row 25 (black/white/red)
30	Row 26 (green/black/white)
31	Row 27 (orange/black/white)
32	Row 28 (blue/black/white)
33	Row 29 (black/red/green)
34	Row 30 (white/red/green)
35	Row 31 (red/black/green)
36	Row 32 (green/black/orange)
37	Lift Switch (white)



# OPERATOR'S MANUAL



## CONNECTOR PIN-OUTS

PM332 Implement Accessory Harness	
Pin #	Description
1	Lift Switch (light green)
2	Hopper # 1 (brown)
3	Hopper # 2 (light blue)
4	Frequency (orange)
5	+8 V Acc Power (yellow)
6	+ 12 V Acc Power (purple)
7	Acc Return (gray)
8	RS-232 Rx (pink)
9	RS-232 Tx (neutral)

PM400 Implement 1 (continued)	
Pin #	Description
26	Sensor return left (black)
27	Sensor return right (black)
28	Row 24 (orange/green)
29	Hopper 1 (black/white/red)
30	Hopper 2 (green/black/white)
31	Shaft/Fan/Flow (orange/black/white)
32	8V power (red)
33	12V switched power (black/red/green)
34	Sensor return (black)
35	RS-232 RX (red/black/green)
36	RS-232 TX (green/black/orange)
37	Lift switch (white)

PM400 Implement 1	
Pin #	Description
1	Row 1 (green)
2	Row 2 (brown)
3	Row 3 (blue)
4	Row 4 (orange)
5	Row 5 (yellow)
6	Row 6 (violet)
7	Row 7 (gray)
8	Row 8 (pink)
9	Row 9 (tan)
10	Row 10 (white/black)
11	Row 11 (red/black)
12	Row 12 (green/black)
13	Row 13 (orange/black)
14	Row 14 (blue/black)
15	Row 15 (black/white)
16	Row 16 (red/white)
17	Row 17 (green/white)
18	Row 18 (blue/white)
19	Row 19 (black/red)
20	Row 20 (white/red)
21	Row 21 (orange/red)
22	Row 22 (blue/red)
23	Row 23 (red/green)
24	+8 V Snsr Pwr Left (red)
25	+8 V Snsr Pwr Right (red)

PM400 Implement 2	
Pin #	Description
1	Row 25 (green)
2	Row 26 (brown)
3	Row 27 (blue)
4	Row 28 (orange)
5	Row 29 (yellow)
6	Row 30 (violet)
7	Row 31 (gray)
8	Row 32 (pink)
9	Row 33 (tan)
10	Row 34 (white/black)
11	Row 35 (red/black)
12	Row 36 (green/black)
13-23	No connection
24	8 V sensor power (red/black/white)
25	8 V sensor power (red)
26	Sensor return (white/black/red)
27	Sensor return (black)
28	No connection
29	No connection
30	No connection
31	No connection
32	No connection
33	No connection
34	No connection
35	No connection
36	No connection
37	No connection

*Dealers have the responsibility of calling to the attention of their customers the following warranty prior to acceptance of an order from their customer for any DICKEY-john product.*

## **DICKEY-john® WARRANTY**

DICKEY-john warrants to the original purchaser for use that, if any part of the product proves to be defective in material or workmanship within one year from date of original installation, and is returned to DICKEY-john within 30 days after such defect is discovered, DICKEY-john will (at our option) either replace or repair said part. This warranty does not apply to damage resulting from misuse, neglect, accident, or improper installation or maintenance; any expenses or liability for repairs made by outside parties without DICKEY-john's written consent; damage to any associated equipment; or lost profits or special damages. Said part will not be considered defective if it substantially fulfills the performance expectations. THE FOREGOING WARRANTY IS EXCLUSIVE AND IN LIEU OF ALL OTHER WARRANTIES OF MERCHANTABILITY, FITNESS FOR PURPOSE, AND OF ANY OTHER TYPE, WHETHER EXPRESS OR IMPLIED. DICKEY-john neither assumes nor authorizes anyone to assume for it any other obligation or liability in connection with said part and will not be liable for consequential damages. Purchaser accepts these terms and warranty limitations unless the product is returned within fifteen days for full refund of purchase price.

**For DICKEY-john Service Department, call  
1-800-637-3302 in either the U.S.A. or Canada**



**Headquarters:**

5200 Dickey-john Road, Auburn, IL USA 62615  
TEL: 217 438 3371, FAX: 217 438 6012, WEB: [www.dickey-john.com](http://www.dickey-john.com)

**Europe:**

DICKEY-john Europe S.A.S, 165, boulevard de Valmy, 92706 – Colombes – France  
TEL: 33 (0) 1 41 19 21 80, FAX: 33 (0) 1 47 86 00 07 WEB: [www.dickey-john.com](http://www.dickey-john.com)

# PM300 - 332 - 400 PLANTER MONITORS



## DICKEY-john Sales

800-637-2952

agsales@dickey-john.com

## DICKEY-john Technical Support

800-637-3302

service@dickey-john.com

## Europe Sales and Technical Support

+33 1 41 19 21 80

europe@dickey-john.com