

VESTA-2813

NS PLUS

MANUAL

STARTING

MAINTENANCE

AND DOSAGE

Please read and follow this operating manual before putting the machine into operation.



SOLÁ seed drills and fertilizer spreaders are manufactured in a highly specialized environment and our factory has a vast customer-endorsed experience.

SOLÁ machines use highly advanced technology and are guaranteed to work without malfunctions in a great variety of conditions. They are provided with easy-to-use and efficient devices.

SOLÁ machines perform excellently with only minimum operator maintenance.

*This manual will help you use your **SOLÁ** product with the upmost efficiency.*



Certified quality system

Beta Edition – May 2015
Ref.: CN-811095/GB
Created by: INTEGRUM

It is forbidden to copy any part of this manual.
Specifications are subject to change or modification without notice.
The pictures included do not necessary show the standard version.

TABLE OF CONTENTS

1. INTRODUCTION	5
2. SAFETY INSTRUCTIONS	6
2.1 SAFETY SYMBOLS	6
2.2 GENERAL SAFETY REGULATIONS	7
2.3 LOADING AND UNLOADING INSTRUCTIONS	7
3. OVERVIEW	8
3.1 SEED DRILL OVERVIEW	8
3.2 TECHNICAL CHARACTERISTICS	9
3.3 MACHINE IDENTIFICATION	9
3.4 USE ACCORDING TO DESIGN	9
3.5 STANDARD EQUIPMENT	10
3.6 OPTIONAL EQUIPMENT	10
4. ESSENTIAL SOWING CONCEPTS	10
4.1 TERRAIN	10
4.2 SEEDS	10
4.3 SEED PLANTING DEPTH	10
5. STARTING	12
5.1 COUPLING THE SEED DRILL	12
5.2 CONNECTING AND ADAPTING THE PTO SHAFT	13
5.3 HYDRAULIC SYSTEM	13
5.4 TRANSPORT POSITION	14
5.5 FILLING AND EMPTYING THE HOPPER	15
5.6 SUPPORTING LEGS	16
5.6.1 FRONT SUPPORTING LEG	16
5.6.2 REAR SUPPORTING LEGS	16
5.7 PARKING	16
5.8 FINISHING WORK WITH THE SEED DRILL	16
6. ADJUSTMENTS	17
6.1 LEVELLING THE SOWING EQUIPMENT	17
6.2 ADJUSTING SEED PLANTING DEPTH	17
6.2.1 ADJUSTING THE PLANTING DEPTH SPINDLES	17
6.2.2 DEPTH ADJUSTMENT WHEELS	17
6.2.3 TINE COULTERS	18
6.3 DOSAGE	18
6.3.1 REGULAR SEEDS (POSITION N)	19
6.3.2 FINE SEEDS (POSITION F)	19
6.4 SEED DOSING ADJUSTMENTS	20
6.5 PREVIOUS FLOW TEST	20
6.6 DOSING FIELD TEST	21
6.7 HARROW	22
6.8 LEVELLER	22
6.9 TRACK ERASER	22
6.10 HYDRAULIC TRACK MARKERS	22
6.10.1 ADJUSTING TRACK MARKER'S LENGTH	23
6.10.2 ADJUSTING TRACK MARKER'S INCLINATION	23
6.11 INCLINATION OF THE FOLDING PARTS	23
7. TYPES OF DISTRIBUTION	24
7.1 SEED DISTRIBUTION BY MECHANICAL FAN	24
7.2 SEED DISTRIBUTION BY HYDRAULIC FAN	24
8. ELECTRONICAL CONTROLLER	25
8.1 FRONT PANEL DESCRIPTION	25
8.2 FORWARD SPEED - C1	25
8.3 TOTAL AREA / SEED DRILL WIDTH - C2	26
8.4 FRONT PANEL WITH PATH MARKER	26
8.5 TRAMLINING - C3	27
8.6 FAN RPM / FAN ALARMS - C4	30
8.7 SEED SHAFT RPM - C5	30
8.8 HOPPER LOW LEVEL ALARM - C6	30
8.9 TOTAL SOWING SHUT-OFF (OPTIONAL)	31
8.10 SHUT-OFF SOWING FROM FOLDING PARTS (OPTIONAL)	31

TABLE OF CONTENTS

9. MAINTENANCE	32
9.1 CHECKING FREQUENCY	32
9.2 SCREWS	33
9.3 CLEANING THE SEED DRILL	33
9.4 GREASING AND LUBRICATION	33
9.5 TYRES PRESSURE	34
10. DOSAGE TABLE	34
10.1 SEEDS TABLE (FOR 1 METERING UNIT)	34
10.2 SEEDS TABLE (FOR 2 METERING UNITS).....	36
10.3 MICRO-FERTILISER TABLE (OPTIONAL).....	38
11. WARRANTY	39
12. NOTES	41

1- INTRODUCTION

It is essential to read and follow the instructions and recommendations in this manual before operating the seed drill **A-6000 NS PLUS**. Careful reading enables maximum operator efficiency, prevents accidents and damage, and increases the seed drill's capacity and life expectancy.

Please ensure that this manual has been read by any person involved in performing **operational tasks**, (including preparation, dealing with mechanical problems and supervising the machine), **maintenance** (inspection and technical assistance) and **transport**.

For your safety, please follow these technical safety instructions as **SOLÀ** will not be responsible for damages caused by not observing the information provided.

In the first chapters you will find the Technical Characteristics and Safety Instructions, as well as some essential sowing concepts. Basic concepts that are required to operate the machine are explained in the Starting and Maintenance sections.

The last part of this manual consists of Dosage Tables, detailed by seed type.



SOLÀ RETAINS THE RIGHT TO MODIFY ILLUSTRATIONS, TECHNICAL DATA AND WEIGHTS INDICATED IN THIS OPERATING MANUAL, IF THESE CHANGES HELP TO IMPROVE THE QUALITY OF THE SEED DRILLS.

2. SAFETY INSTRUCTIONS

2.1 SAFETY SYMBOLS

In this operating manual you will find three different symbols relating to safety:



TO WORK MORE EASILY WITH THE SEED DRILL.



TO PREVENT DAMAGE TO THE SEED DRILL AND OPTIONAL EQUIPMENT.



TO PREVENT PHYSICAL INJURY.

On the machine you will find the following warning pictograms:



Read the instructions carefully and observe the safety advice given in the operating manual.



During the coupling manoeuvre, stay away from the rear part of the tractor. **Risk of serious physical injury.**



During maintaining or repairing the seed drill, you must stop the tractor's engine completely and remove the ignition key.



Never stand under the sowing equipment, or swivel area of the machine's extension tine coulters. **Risk of serious physical injury.**



Risk of being crushed when working under the machine, please secure the machine to prevent this risk. **Risk of serious physical injuries.**



Never use the ladder to access the platform when the machine is running. It is forbidden to ride on the machine during operation. **Risk of serious physical injuries.**



Danger of infection from escaping hydraulic fluid at high pressure! This can inflict serious injuries with potentially fatal consequences if it passes through the skin and into the body. Keep the hose lines in good condition. **Risk of serious physical injuries.**



Never stand under track markers or in their operational area. **Risk of serious physical injuries.**



Do not put your hand into the hopper while the wheels are turning. **Risk of serious physical injuries.**



Do not exceed maximum load.



Coupling point for transport by crane. See section 2.3 LOADING AND UNLOADING INSTRUCTIONS).

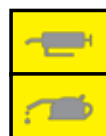

Keep greased and in good condition the parts of the machine showing this greasing and lubrication symbol. See section 9.4 GREASING AND LUBRICATION.



PTO shaft's speed and turning direction (only in machines with mechanical fans).

2.2 GENERAL SAFETY REGULATIONS



- Before starting the machine, please check the machine is in good condition for work and is safe for road use.



- Check that visibility is clear around the machine and there is no person in the working area.



- In thoroughfare, please observe traffic signs and regulations.



- It is forbidden to ride on the machine or climb into the machine when it is running.



- Before using the machine, the user must be familiar with all operating elements.



- Please be extremely careful when coupling and uncoupling the machine to the tractor.



- Please check that the PTO shaft is in good condition and well protected. Prevent the protective tube from turning by holding both the tube and chain provided for this purpose.



- Mount the PTO shaft's transmission only when the tractor's engine is off.



- Before connecting the PTO shaft, be sure that the danger zone surrounding the machine is clear.



- Never leave the tractor's driver's seat while the machine is in operation.



- Do not deposit external elements inside the hopper.



- When maintaining the hydraulic system of the seed drill, make sure that it is depressurised and the tractor's engine is off.



- Please regularly check the condition of the tubes and hosepipes in the hydraulic system. These parts age naturally and their life should not surpass 6 YEARS. Please replace when necessary.



- During transit with the raised seed drill, block the lowering switch. Before leaving the tractor, lower the seed drill onto the ground and remove the tractor's starting key.



- Always use enough supporting elements when maintaining the machine in a raised position to prevent the machine from lowering or falling.



- Before sowing, evaluate potential risks arising from the terrain, such as steep slopes and a possible contact between high tension overhead cables and the seed drill. The latter could be caused by uneven ground and/or the configuration of the seed drill's mobile components.

2.3 LOADING AND UNLOADING INSTRUCTIONS



THESE OPERATIONS SHOULD BE PERFORMED ONLY BY QUALIFIED AND EXPERIENCED PERSONNEL



-WHEN THE SEED DRILL IS DELIVERED, IT SHOULD BE IMMEDIATELY CHECKED TO DETECT POSSIBLE DAMAGES DURING TRANSPORTATION OR MISSING PIECES. ONLY THE IMMEDIATE REPORTING OF THIS TO THE DELIVERER WILL RESULT IN COMPENSATION.



LOADING AND UNLOADING THE MACHINE MUST BE PERFORMED, IF POSSIBLE, USING A BRIDGE CRANE.

OVERVIEW



WARNING: IN ORDER TO KNOW THE LOAD TO BE SUPPORTED BY THE BRIDGE CRANE, SEE SECTION 3.2 TECHNICAL CHARACTERISTICS

The following pictures show how to place the tow ropes in order to perform the operation:

- **FRONT PART:** one tow rope must be fastened to the coupling point placed in the inner front side of the hopper (Fig. 2).

- **REAR PART:** two tow ropes must be fastened to the fastening points situated in the sowing equipment's frame (Fig. 3).



3. OVERVIEW

3.1 SEED DRILL OVERVIEW

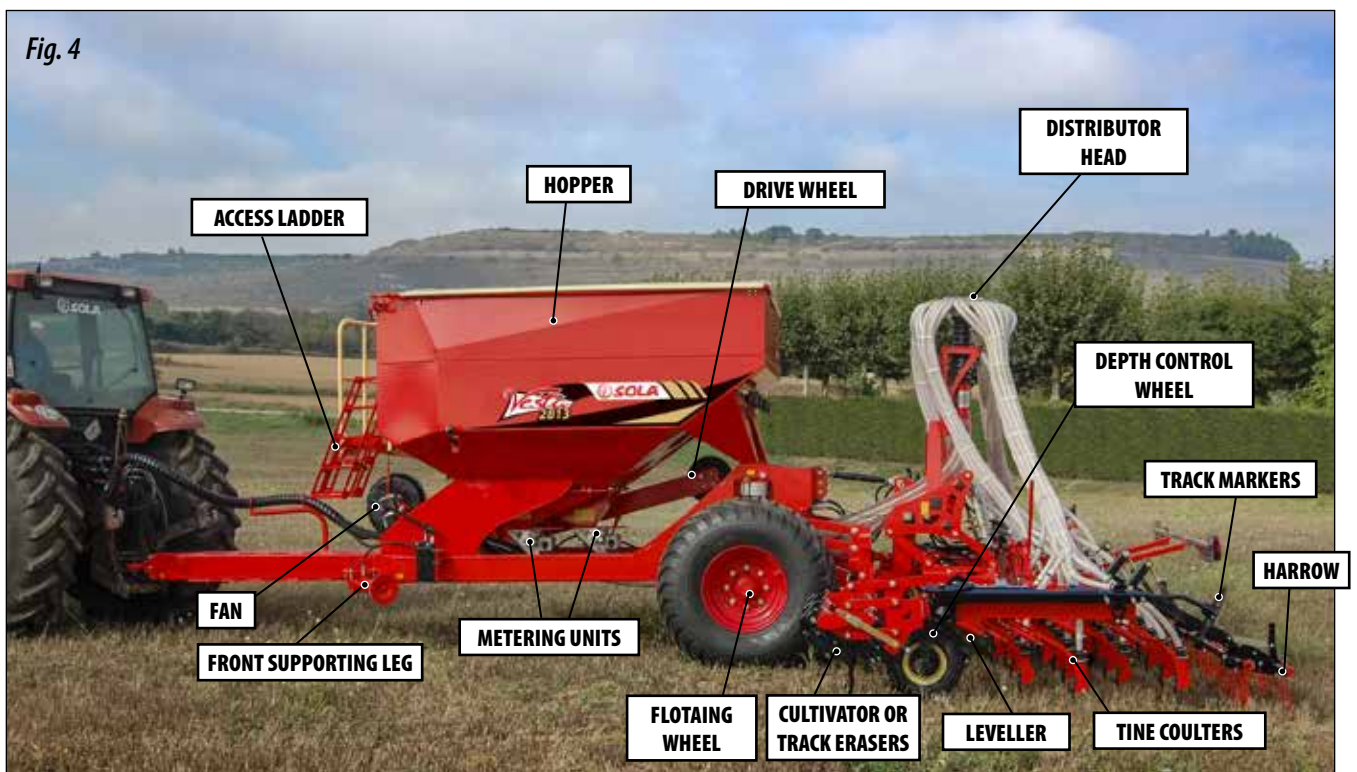

3.2 CARACTERÍSTICAS TÉCNICAS

MACHINE TYPE / ROWS NR.	ROWS SPACING (cm)	HOPPER CAPACITY (Litros)	EMPTY SEED DRILL WEIGHT (Kgr.)	TYRES TYPE
600/43	14	6000	5.900	550/60-22.5
600/48	12,5	6000	5.950	550/60-22.5
700/48	14,6	6000	6.100	550/60-22.5

MACHINE TYPE / ROWS NR.	WORKING WIDTH (m)	TRANSPORT WIDTH (m)	HEIGHT without track markers (m)	LENGTH (m)
600/43	6	3	3,4	10
600/48	6	3	3,4	10
700/48	7	3	3,9	10

3.3 MACHINE IDENTIFICATION

Every machine has an IDENTIFICATION PLATE in the three-point linkage that specifies:

- 1- Name and address of the manufacturer.
- 2- Brand SOLÀ.
- 3- Machine model.
- 4- Machine type.
- 5- Serial number.
- 6- Official approval number.
- 7- Maximum authorised weight (Kg.).
- 8- CE certificate.

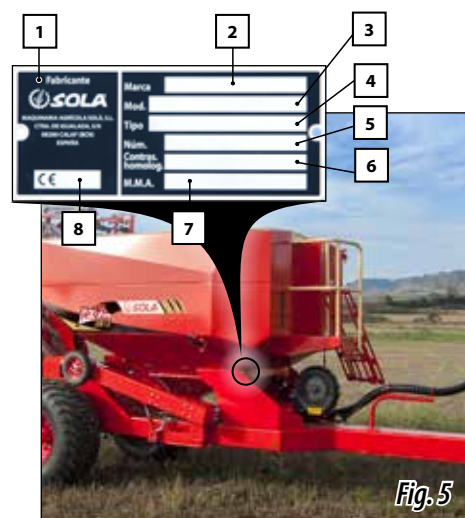

3.4 USE ACCORDING TO DESIGN

The seed drill **VESTA-2813 NS PLUS** has been designed specifically for the sowing of cereal and other grain seeds.

The machine has been designed to be trailed using an agricultural tractor .

If the machine is used in circumstances other than those specified above, the manufacturer will not be held responsible for any damage caused to persons or to the machine (see section 11. WARRANTY).

The user must observe all regulations concerning safety, traffic and hygiene.

If the machine is modified by the user, the manufacturer's warranty is cancelled. SOLÀ will not be held responsible for any damage caused to persons or to the machine (see section 11. WARRANTY).

The use of seeds with a high moisture content should be avoided since they can cause blockages.

3.5 STANDARD EQUIPMENT

- 6000 L Seed Hopper (in model VESTA-2813 NS PLUS).
- Sieve
- Kit for dosing test.
- Ladder and platform to gain access to the hopper
- Central ratchet with slide to adjust planting depth.
- Adjustable side wheels for planting depth controlling.
- Front height-adjustable supporting leg.
- Sowing equipment supporting legs.
- Hopper's folding cover
- Signalling light equipment
- Hydraulic service brake.
- Brake shoes
- Monitor displaying: fan r.p.m., seed distributor shaft r.p.m., hopper's seed level sensor and hectare counter.
- Mechanical total sowing shut-off
- Authorisation for road use
- Rear harrow with three independent sections.
- Sowing equipment consisting of 4 rows of tine coulters.
- Hydraulic or mechanical fan.
- Working Lamps
- Track eraser.
- Hydraulic track markers.

3.6 OPTIONAL EQUIPMENT

- Combined hopper: 3600 L for seeds and 2400 L for fertiliser (in models VESTA-2813 NS PLUS-COMBI).
- Combined hopper: 4200 L for seeds and 1800 L for micro-fertiliser (in models VESTA-2813 NS PLUS-MICRO).
- Shut-off sowing from folding parts
- Tramlines
- Hydraulic kit: hydraulic pump fitted on the tractor's universal joint shaft, refrigerated oil tank
- Seed distributor's transmission with electric engine and control panel for variable dosing or total sowing shut-off.
- Kit containing 2 pilot-valves for the tractor's hydraulic connections.
- Artemis radar.
- Leveler with three sections.

4- ESSENTIAL SOWING CONCEPTS

4.1 TERRAIN

The better the soil condition, the better the sowing quality. Work is more difficult on big clods or uneven furrows.

Although **SOLA** machines resist harsh conditions, if the seedbed does not satisfy appropriate conditions then the sowing quality will suffer.

4.2 THE SEED

It is essential that seeds are well maintained and clean. Barley seeds should be trimmed.

4.3 SEED PLANTING DEPTH

The seed planting depth has consequences for tillering, as well as for the plant's strength and its ability to resist frostbite or drought. The parent shoot grows from 1 to 2 cm under the ground, whatever the depth of the seed.

Planting deeper does not necessarily mean getting deeper roots. Only a few roots grow from the lower part of the seed. Most of them grow from a parent shoot close to ground level.

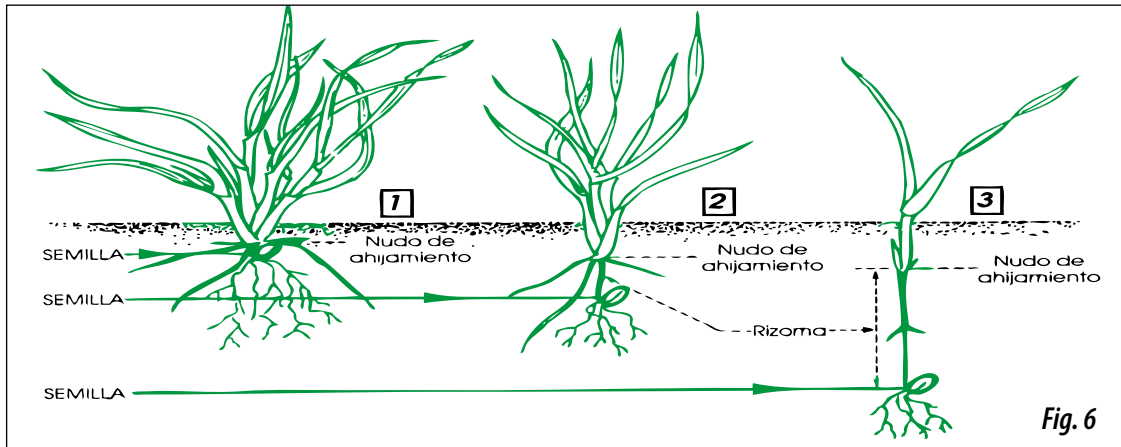

THE RECOMMENDED SEED PLANTING DEPTHS ARE FROM 3 TO 5 CENTIMETRES. PLANTING TOO DEEP CAUSES PROBLEMS AS RHIZOME CANNOT REACH THE SURFACE AND THE PLANT WILL DIE. IT DOES NOT MATTER THAT SOME GRAINS ARE VISIBLE BECAUSE THE HARROW'S. TINES WILL COVER THEM EVENTUALLY.

Normal Planting Depth: from 2 to 4 cm

Thick stem, short rhizome and resistant to frostbite.

Multiple tillering providing from 3 to 6 shoots and a lot of blades, from 6 to 10.

Deep and thick roots, approximately 5 cm in width and 10-12 cm in depth.

With less grains per sowing square metre, more ears are obtained.

Deeper Planting: from 5 to 6 cm

Fine stem, rhizome exposed to frostbite.

Late and weak tillering, 1 or zero shoots and only a few blades, 3-4 aprox.

Medium quality roots of approximately 3 cm in width and 5 cm in depth.

More grains per sowing square metre are required to obtain the same number of ears as in the previous case.

Very deep planting: from 8 to 10 cm

Very fine stem. No tillering and only one blade.

Seed runs out of supplies by growing a long rhizome which frostbite can easily cut.

The plant takes weak roots, approximately 1 cm in width and 3 cm in depth.

Twice the number of grains per sowing metre are required to obtain the same number of ears as in the first case.



IN VERY COLD PLACES, REPEATED FROSTBITE CAN HAVE A HONEYCOMB EFFECT ON THE GROUND'S MOST SUPERFICIAL LAYER. IN THIS CASE THE PLANT'S VERY FIRST ROOTS CAN LOOSEN AND THE PLANT WILL DIE. SLIGHTLY DEEPER PLANTING IS RECOMMENDED AND IF POSSIBLE, THE USE OF ROLLERS TO COMPACT THE EARTH TO BETTER PROTECT THE SEEDS.



WHEN STARTING THE MACHINE, FURROWS WILL NOT CONTAIN ANY SEEDS FOR A METRE. WHEN STOPPING THE MACHINE, SEEDS WHICH WERE PREVIOUSLY INSIDE THE SEED HOSES, SLIDE FROM THE MACHINE AND END UP PILED ON THE GROUND. TAKE THIS INTO ACCOUNT WHEN STOPPING AND STARTING THE MACHINE IN ORDER TO ACHIEVE MORE ACCURACY.



ALWAYS WORK AT A UNIFORM SPEED AS SUDDEN ACCELERATING AND SLOWING DOWN WILL CAUSE AN IRREGULAR SEED DISTRIBUTION.

5. STARTING

Before starting the seed drill, give special attention to the following points:

- Check that all mechanical components of the machine are well lubricated. Grease periodically the mechanical parts (see section 9.4 GREASING AND LUBRICATION).
- Check the tyre pressure (see section 9.5 TYRE PRESSURE).
- Check that the ducts from both the hydraulic and the pneumatic systems (seed carrying) are in good condition.

After coupling the seed drill to the tractor:

- Make sure the machine is well secured to the tractor.
- Before using the machine, the user must be familiar with all operating elements.
- Operate the seed drill while it is empty in order to free the ducts from condensed water or residues.
- Adapt the machine and all its configuring elements to the type of terrain and seed to be sown.

5.1 COUPLING THE SEED DRILL

Seed drill **VESTA-2813 NS PLUS** is equipped with a coupling of type axle-swivelling ring.



DURING THE COUPLING AND UNCOUPLING MANOEUVRE CHECK THAT NO PERSON OR OBJECT IS PLACED BETWEEN THE TRACTOR AND THE SEED DRILL.



BE ESPECIALLY CAREFUL DURING COUPLING AND UNCOUPLING THE MACHINE. GIVE MAXIMUM ATTENTION TO THESE OPERATIONS TO PREVENT PHYSICAL DAMAGES TO THE WORKER.

To perform the coupling manoeuvre, follow these steps:

1- Connect the following plugs from the seed drill's hydraulic system to the tractor control unit:

- 1.1-** FOLDING PARTS OF THE SOWING EQUIPMENT
- 1.2-** TRACK MARKERS
- 1.3-** SOWING EQUIPMENT AND TRACK ERASER
- 1.4-** HYDRAULIC FAN
- 1.5-** HYDRAULIC SERVICE BRAKE



THE REQUIRED HYDRAULIC CONNECTIONS FOR THIS ELEMENTS ARE SPECIFIED IN SECTION 5.3 HYDRAULIC SYSTEM.



ONCE THE SEED DRILL IS COUPLED TO THE TRACTOR, THE PTO SHAFT SHOULD BE ADAPTED IF THE MACHINE IS EQUIPPED WITH MECHANICAL FAN (SEE SECTION 5.2 CONNECTING AND ADAPTING THE PTO SHAFT).

2- Connect the electric plug for the lights equipment.

3- Couple the seed drill's swivelling ring to the tractor using the trailer coupling point (Fig. 7).



IN CASE THE COUPLING POINT IS TOO LOW, LOWER THE FRONT SUPPORTING LEG. SEE SECTION 5.6.1 FRONT SUPPORTING LEG.

4- Raise the seed drill's supporting leg.



BEFORE MOVING THE SEED DRILL, MAKE SURE IT IS WELL SECURED TO THE TRACTOR.



TO UNCOUPLE THE MACHINE FROM THE TRACTOR, PERFORM THE PREVIOUS STEPS IN REVERSE ORDER.

5.2 CONNECTING AND ADAPTING THE PTO SHAFT

Once the seed drill is coupled with the tractor, the PTO shaft should be adapted if the machine is equipped with mechanical fan. To perform this operation, follow these steps:

- 1- The PTO shaft needs to be dismantled and one of its ends needs to be inserted into the tractor's universal joint shaft. The other end needs to be inserted into the seed drill. To perform this, insert the PTO shaft into the axles of both machines while keeping the safety pin pressed. Then, release the safety pin and pull the PTO shaft back until you hear "click". That means that the pin is in place.



MOUNT THE PTO SHAFT BY CONNECTING THE HOMOKINETIC JOINT TO THE TRACTOR'S UNIVERSAL JOINT SHAFT.



WHEN OPERATING THE PTO SHAFT CHECK THAT THE ENGINE IS OFF. ALWAYS WORK WITH THE PTO SHAFT PROTECTED AND IN GOOD CONDITION. PREVENT THE PTO SHAFT'S TUBE FROM TURNING BY SECURING IT WITH THE CHAIN PROVIDED.

- 2- Look for the minimal movement length "L" (fig. 8) by raising and lowering the hydraulic lift.

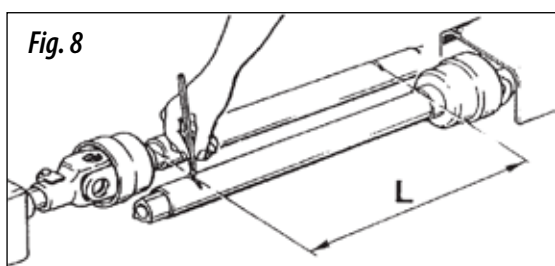

- 3- Cut the spare plastic and metal into parts of the same length and remount the PTO shaft (Fig. 9).

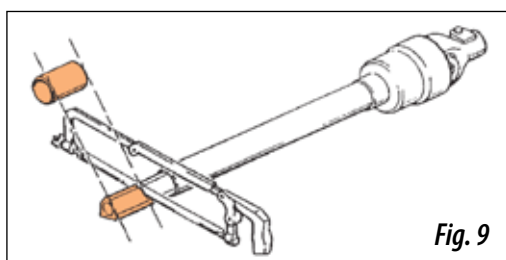

- 4- Operate the hydraulic lift and check that the PTO shaft's movement is correct.

- 5- Secure the PTO shaft using the chain (Fig. 10).

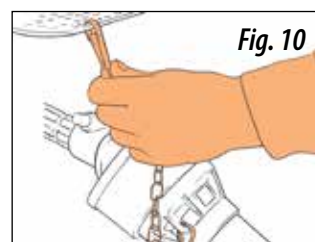

WHEN LOWERING THE SEED DRILL TO THE GROUND, UNPLUG THE TRACTOR'S UNIVERSAL JOINT SHAFT SO THAT THE PTO SHAFT DOES NOT HAVE AN EXCESSIVE INCLINATION (MAX. 35°).



WHEN HOLDING THE TRACTOR UNIVERSAL JOINT SHAFT'S CLUTCH IN, PERFORM IT GENTLY. STARTING SUDDENLY COULD SERIOUSLY DAMAGE THE SEED DRILL.

5.3 HYDRAULIC SYSTEM

To use the machine's hydraulic connections you will need:

- To FOLD AND UNFOLD THE MACHINE: a double-acting connection.
- To FOLD AND UNFOLD THE TRACK MARKERS: a double-acting connection.
- To LOWER AND RAISE THE SOWING EQUIPMENT AND THE TRACK ERASER (optional): a double-acting connection with a shut-off valve to exclude the track eraser.
- HYDRAULIC FAN: one single-acting connection.
- HYDRAULIC SERVICE BRAKE: a single-acting connection.

The different hydraulic circuits are distinguished by their cap's colour, as shown in this table:

COLOUR OF THE CAP	DESCRIPTION
BLUE	Track marker's hydraulic system.
GREEN	Hydraulic system to fold and unfold the sowing equipment
RED	Service brake's hydraulic system.
YELLOW	Hydraulic system to lower and raise the sowing equipment and the track eraser.

STARTING

To smoothly hydraulically fold and unfold the seed drill, there are two flow regulators (Fig. 11) that perform both actions respectively.

They should be adjusted depending on the hydraulic flow supplied by the tractor. Starting with an almost completely closed flow regulator is recommended to prevent folding too fast, which could damage the seed drill.

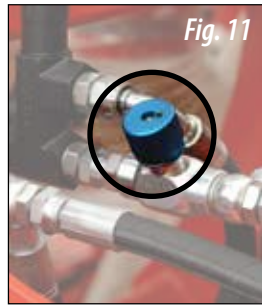

The machine is also provided with hydraulic safety triggers (1, Fig. 12) to secure the folding parts during transit. The figure shows the trigger in the safety position.

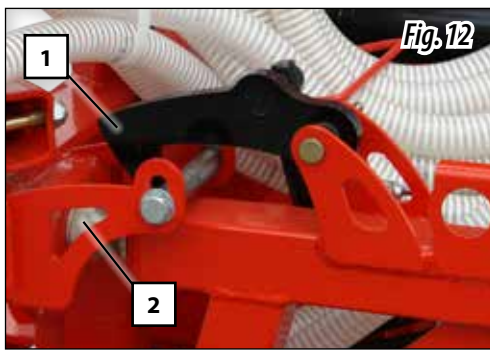

IF, AFTER PRESSURISING THE HYDRAULIC SYSTEM OF THE FOLDING PARTS, THEY DO NOT LOWER, MAKE SURE THE SAFETY TRIGGERS HAVE BEEN UNFASTENED (1, FIG. 12). OTHERWISE FOLD THE EQUIPMENT AND ADJUST THE FOLDING STOPS (2, FIG. 12).



BEFORE FOLDING OR UNFOLDING THE FOLDING PARTS AND THE TRACK MARKERS, MAKE SURE THERE ARE NO OBJECTS IN THEIR OPERATIONAL AREA AND NO PERSON IS STANDING CLOSE TO THE MACHINE.



WHILE MAINTAINING OR REPAIRING THE SEED DRILL, ALL HYDRAULIC CONNECTIONS MUST BE UNPLUGGED.



KEEP THE DUCTS FROM THE HYDRAULIC SYSTEM IN GOOD CONDITION. OIL AT HIGH PRESSURE CAN INFLICT SERIOUS INJURIES WITH POTENTIALLY FATAL CONSEQUENCES IF IT PASSES THROUGH THE SKIN AND INTO THE BODY.



USE ONLY HYDRAULIC PLUGS PROVIDED BY THE MANUFACTURER.

5.4 TRANSPORT POSITION

Once the machine is coupled to the tractor and the hydraulic circuits are connected to the tractor's hydraulic connections, follow these steps in order to set the machine for transport position:



- 1- Fold the track markers.
- 2- Fix the ROLLERS by placing the bolts (A, fig. 14.1).
- 3- Raise folding parts and check that the hydraulic safety triggers (Fig. 14.2) are correctly fastened.

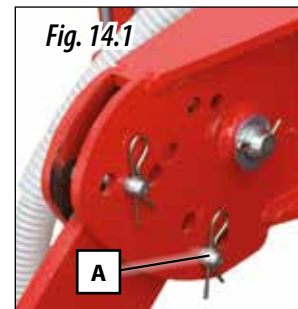

- 4- In case the track eraser is lowered, check that its shut-off valve is open.

- 5- Raise both the sowing equipment and the track eraser until reaching their maximum height.



AFTER FOLDING THE MACHINE AND BEFORE TRANSPORTING IT, CHECK THAT THE TRACK ERASER HAS BEEN RAISED. IF NOT, CHECK THAT THE SHUT-OFF VALVE IS OPEN AND REPEAT THE STEPS EXPLAINED ABOVE IN THIS SECTION.



PREVENT THE MOBILE ELEMENTS FROM MOVING.

5.5 FILLING AND EMPTYING THE HOPPER

In order to safely and quickly fill the hoppers, the best way is using a worm drive. A hydraulic crane can also be used to raise the BIG BAG above the hopper in order to fill it. Check that the whole bag volume fits into the hopper. To secure the BIG BAG to the crane, follow the instructions provided by the its manufacturer.



IMPORTANT: BEFORE FILLING THE HOPPER, MAKE SURE IT DOES NOT CONTAIN ANY SEED RESIDUES OR OBJECTS. IF STHEY EXIST, THE HOPPER NEEDS TO BE EMPTIED AND CLEANED.



BEFORE FILLING THE HOPPER, MAKE SURE THE EMPTYING TRAPDOORS ARE CLOSED.

To **FILL** the hopper, follow these steps:

- 1- Pull the safety trigger (Fig. 15) to free the hopper's ladder. Next, pull the ladder until it is horizontal (Fig. 16).
- 2- Free the piece that secures the hopper's folding cover (Fig. 17).

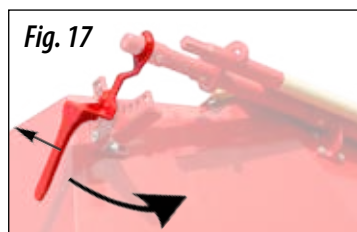

- 3- Take the handle and insert it at the folding point placed at the end of the hopper's cover (Fig. 18). Turn it to fold the cover over (Fig. 19).

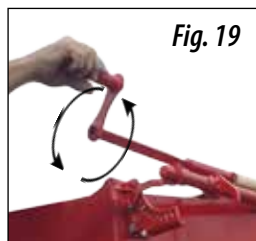
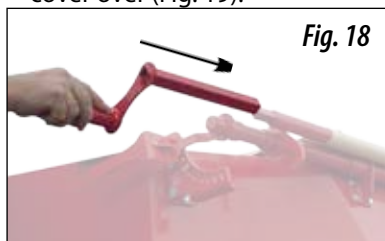

- 4- Fill the hopper with seeds.
- 5- Once the hopper has been filled, fold the hopper's cover, put the handle away and fold the hopper's ladder back to its place.



FOLD THE LADDER AFTER FILLING OR EXAMINATING THE HOPPER.

To **EMPTY** the hopper, follow these steps:

- 1- Place a container or a sack in front of the metering unit's emptying trapdoor (Fig. 20).
- 2- Pull and turn the handle to open the trapdoor and empty the hopper (1, Fig. 20).
- 3- When the hopper is empty, close the trapdoor by turning the handle (1, Fig. 20).

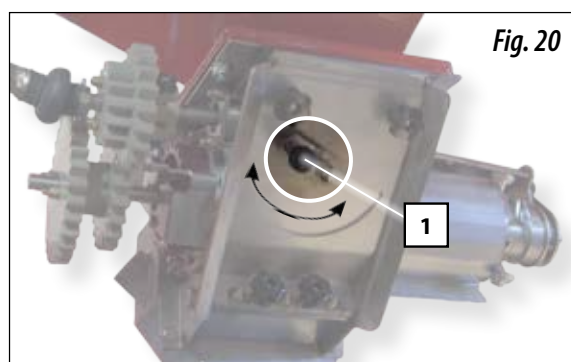

For a **QUICK EMPTY** of the hopper, follow these steps:

- 1- Loosen the knobs (2, Fig. 21) and remove the lid.

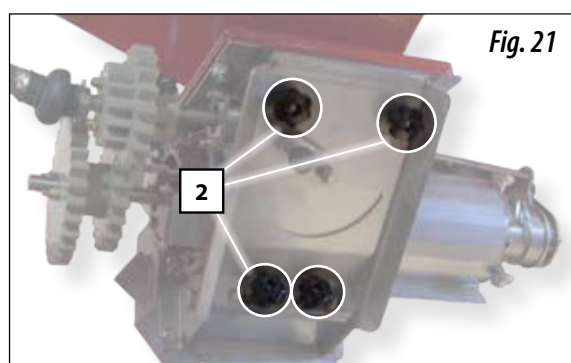

- 2- Once the seeds stop falling, place the lid and the knobs back (Fig. 21).



IN CASE NO SEEDS ARE FALLING, CHECK THAT THE LID WHICH ALLOWS THE SEEDS TO ENTER TO THE METERING UNIT IS OPEN (FIG. 22).

STARTING

5.6 SUPPORTING LEGS

The seed drill is equipped with a supporting leg for the hopper (see section 5.6.1 FRONT SUPPORTING LEG) and two supporting legs for the sowing equipment (see section 5.6.2 REAR SUPPORTING LEGS).



RAISE THE SUPPORTING LEGS BEFORE PUTTING THE SEED DRILL TO WORK, SINCE IF THEY STAY LOWERED DURING WORK, THE MACHINE MAY BE DAMAGED.



ALWAYS OPERATE THE SUPPORTING LEGS WITH THE SEED DRILL COUPLED TO THE TRACTOR.

5.6.1 FRONT SUPPORTING LEG

The front supporting leg is placed in the hopper's drawbar. To **PLACE** the supporting leg, follow these steps:

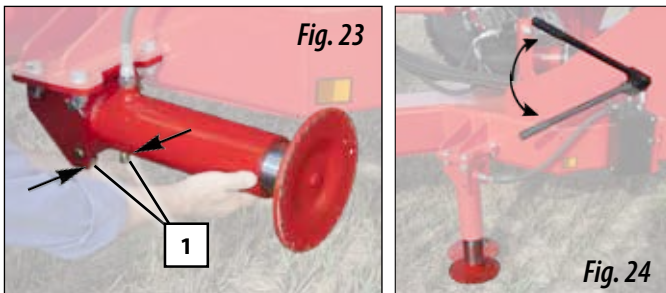

- 1- Handle the supporting leg using one hand and use the other hand to operate the safety locks to unlock it (1, Fig. 23).
- 2- Lower the supporting leg until the safety locks are fixed (2, Fig. 24).
- 3- Use the crank to adjust the height of the supporting leg (Fig. 24).

To **RAISE** the supporting leg, follow these steps:

- 1- Loosen the valve (2, Fig. 25) to raise the supporting leg's telescopic system.
- 2- Unlock the safety locks (1, Fig. 23) and raise the supporting leg until the safety locks are fixed.
- 3- Tight the valve (2, Fig. 25).

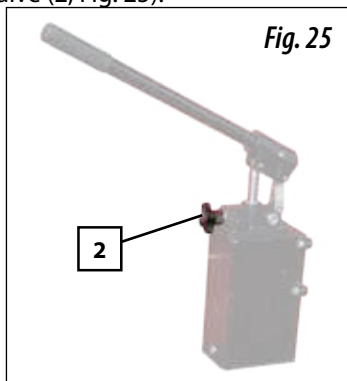

5.6.2 REAR SUPPORTING LEGS

The rear supporting legs are placed in the sowing equipment. To **RAISE** or **LOWER** the supporting leg, follow these steps:

- 1- Remove the safety pin (A, Fig. 28) and the bolt (B, Fig. 28) to free the supporting leg.
- 2- Move the supporting leg to the desired position.
- 3- Place both the safety pin (A, Fig. 28) and the bolt (B, Fig. 28) back to fix the leg's new position.

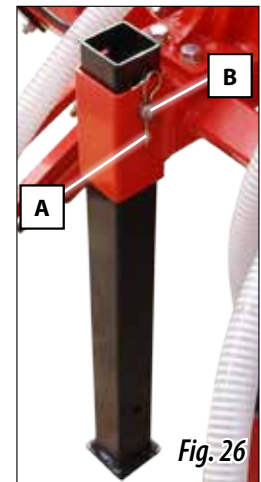

5.7 PARKING

When parking the seed drill, brake shoes must be placed in the floating wheels. The brake shoes are stored in the front part of the seed drill.



DO NOT FORGET TO PLACE THE BRAKE SHOES AFTER FINISHING WORK WITH THE SEED DRILL (FIG. 27).

5.8 FINISHING WORK WITH THE SEED DRILL

- Completely empty the hopper from seeds and fertiliser.
- Wash the machine well with a lot of water, making sure that no seeds, fertilizer or other products remain inside the hoppers, metering units or ducts. Wash especially the parts of the seed drill which are in contact with chemical products (see section 9.3 CLEANING THE SEED DRILL).
- Thoroughly check all components of the seed drill and replace the ones which are damaged or worn.
- Delete any particle that can cause corrosion. If necessary, use anti-corrosion paint.
- Grease and lubricate the indicated parts, chains, cogs and pinions (see section 9.4 GREASING AND LUBRICATION).

6. ADJUSTMENTS

This chapter shows the adjustments to be performed to the seed drill VESTA-2813 NS PLUS in order to adjust it to the type of seed and terrain properties. Values shown in this manual could be different depending on the terrain conditions, weather factors or the condition of the machine.

6.1 LEVELLING THE SOWING EQUIPMENT

To level the sowing equipment, operate the tensioner placed in the rear part of the hopper (1, fig. 29).

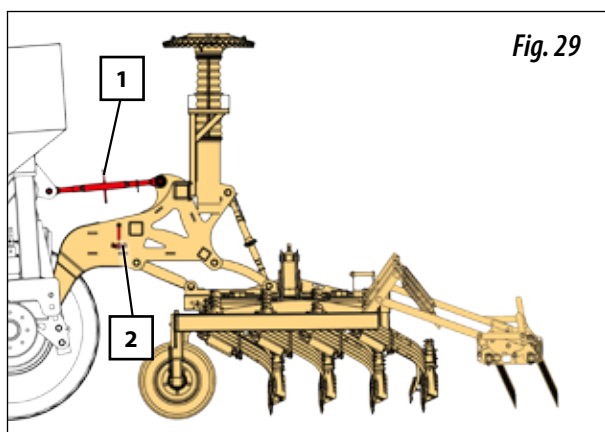

ON THE SIDE OF THE FRAME THERE IS AN INDICATING ARROW ALONG WITH LEVELLING MARKS (2, FIG. 29).



VERY IMPORTANT: PERFORM THIS ADJUSTMENT WITH THE SEED DRILL COUPLED TO THE TRACTOR.

6.2 ADJUSTING SEED PLANTING DEPTH

Seed planting depth is adjusted by means of:

- Two **PLANTING DEPTH SPINDLES**, see section 6.2.1
- **DEPTH ADJUSTMENT WHEELS** at the sides of the sowing equipment. See section 6.2.2
- The **TINE COULTERS**, see section 6.2.3

6.2.1 ADJUSTING THE PLANTING DEPTH SPINDLES

Seed planting depth will be determined by the two spindles (3, Fig. 30), both should be adjusted to the same planting depth. These spindles are placed in the rear part of the seed drill.

The spindles are adjusted using a ratchet. Once the spindles have been adjusted, the ratchets should be folded so that they do not interfere with the folding and unfolding of the folding parts of the seed drill.

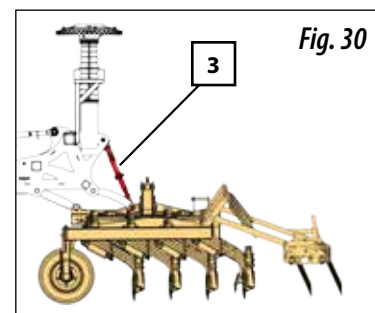

FOR A QUICK ADJUSTMENT OF THE SEED PLANTING DEPTH, FIRST ADJUST THE SPINDLES (3, FIG. 31) TO POSITION (0). THEN OPERATE THE STOPS OF THE TRAILED TANK (FIG. 31).



VERY IMPORTANT: REMOVE THE SAME AMOUNT OF STOPS ON EACH SIDE AND DO IT IN THE INDICATED ORDER (FIG. 31).



VERY IMPORTANT: THE FIXING BOLTS MUST BE ALWAYS IN PLACE. REMOVE THEM ONLY TO ADJUST THE SEED DRILL.



6.2.2 DEPTH ADJUSTMENT WHEELS

The side wheels of the sowing equipment (4, Fig. 32) control the planting depth of the folding parts. To adjust these wheels, use the wrench (A, Fig. 33) provided with the seed drill and follow these steps:

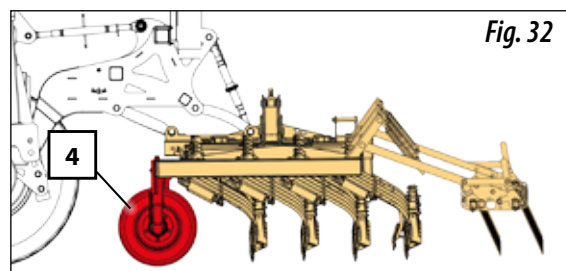

ADJUSTMENTS

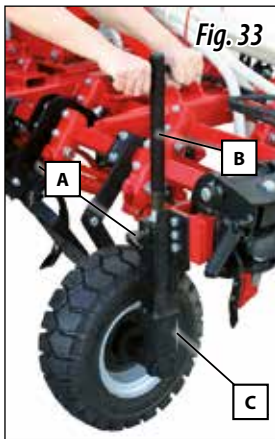

- 1- Unlock the wheel using the fixing handle.
- 2- Place the wrench (A, Fig. 35) and turn it towards the right or the left in order to lower or raise the sowing equipment.
- 3- Use the graduated scale (B, Fig. 35) to adjust the desired height to work.
- 4- Remove the wrench and lock the wheel using the fixing handle.



WHEN SOWING A WORKED OR DETACHED GROUND, TAKE THE PRECAUTION OF SET THE SIDE WHEELS ONE OR TWO POINTS LESS TO COMPENSATE THE SINKING OF THE WHEEL INTO THE GROUND. ADJUST THE WHEELS TO POSITION 2 ON THE GRADUATED SCALE.



FOR A UNIFORM SOWING, ADJUST BOTH WHEELS TO THE SAME HEIGHT.

6.2.3 TINE COULTERS

The seed drill is equipped with two different types of tine coulters:

FIXED TINE COULTERS

These tine coulters cannot be adjusted in height. For this reason, the planting depth is going to depend only on the main adjusting spindles of the subframe (see section 6.2.1 ADJUSTING THE PLANTING DEPTH SPINDLES). The pressure of these coulters can be adjusted by operating the nut which is in the spring's lower part (1, Fig. 34). The coulters are fixed to their support by means of a special screw SOLÀ (2, Fig. 34) with a self-locking nut. Operating this nut, the side looseness of the tine coulters is adjusted.

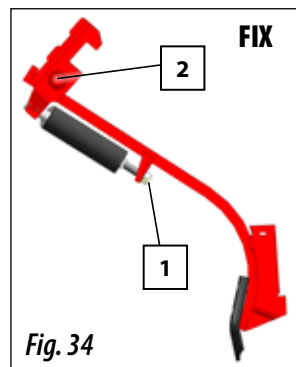

HEIGHT-ADJUSTABLE TINE COULTERS

These tine coulters coincide with the tractor's wheels and the seed drill's wheels.



IMPORTANT: IN CASE OF VERY DEEP TRACK MARKERS, IT IS NECESSARY TO OPERATE THESE TINE COULTERS.

Pressure performed by the tine coulters can be adjusted by using the nut of the spring (1, fig. 35). These tine coulters are fixed to their support by a special SOLÀ screw (2, Fig. 35) with a self-locking nut. Operating this nut, the side looseness of the tine coulter is adjusted. These tine coulters are adjustable in depth, following these steps:

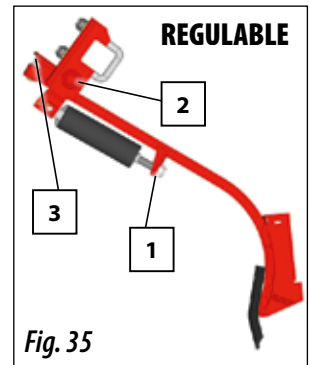

- 1- Adjust the screws and nuts (3, Fig. 35)
- 2- Place the tine coulter at the desired position.

6.3 DOSAGE

The metering unit (Fig. 36) allows 2 ways of dosing:

- For **REGULAR** seeds (Position N).
- For **FINE** seeds with minimum flow rate (Position F).

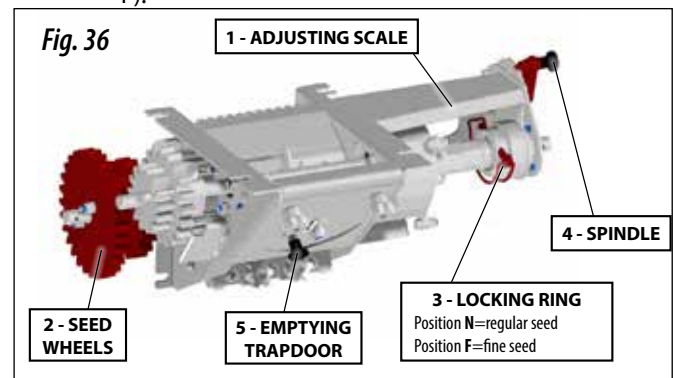

WHEN CHANGING THE POSITION BOLT AND THE CLIP PIN OF THE AIR OUTLET TO THE FAN, IT IS ESSENTIAL THAT THE SEED DOSING ROLLER CAN TURN FREELY AND THE HOPPER IS EMPTY.



IMPORTANT: SET THE FAN ADJUSTING SWITCH (FIG. 37) DEPENDING ON THE SEED TO BE USED (REGULAR-POSITION N; FINE-POSITION F).

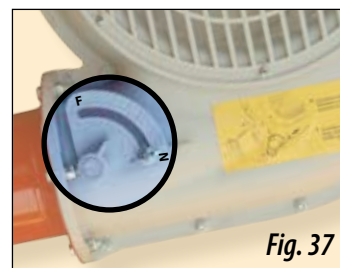

6.3.1 REGULAR SEEDS (position N)

To adjust the sowing to **REGULAR SEEDS**, proceed as following:

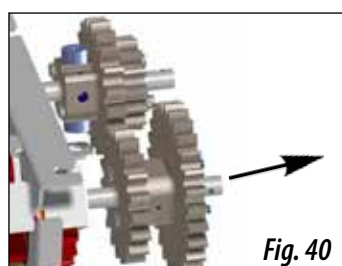
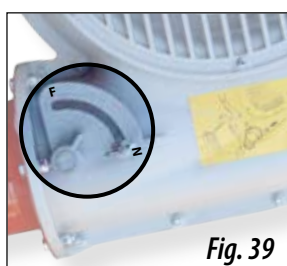
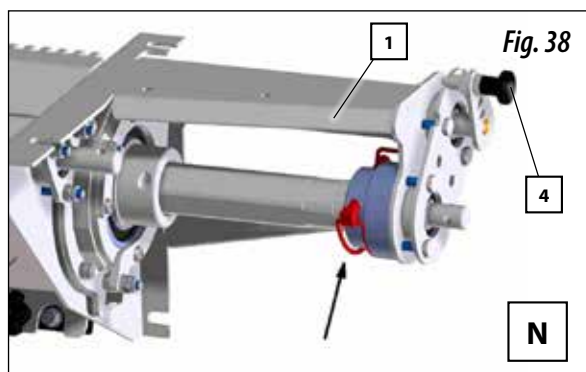

THE LOCKING RING MUST BE IN NORMAL POSITION (IN RED, FIG. 38).

- 1- Slightly pull and turn the spindle (4, Fig. 38) to adjust the dosing.
- 2- Set the pinion gears in **position N** (Fig. 40).
- 3- Set the fan adjusting switch to **position N** (Fig. 39).



THE AIM OF MICRODOSING IS TO BETTER DISTRIBUTE BOTH FINE AND REGULAR SEEDS IN SMALL NUMBERS.



THE CORRECT VALUE TO USE F-MICRODOSING MODE FOR FINE SEEDS CAN BE FOUND IN THE DOSING TABLES (SEE SECTION 10- DOSAGE TABLES).



CHECK THE CONDITION OF THE CLEANING BRUSH BEFORE STARTING TO SOW FINE SEEDS.

6.3.2 FINE SEEDS (position F)

To adjust the sowing to **FINE SEEDS**, proceed as following:

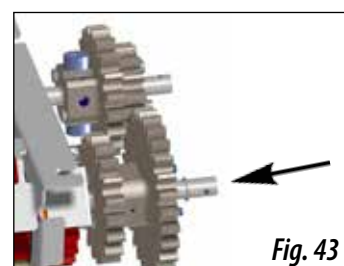
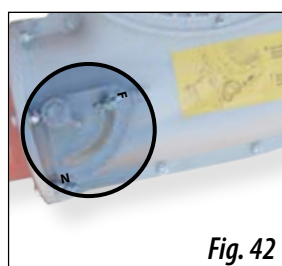
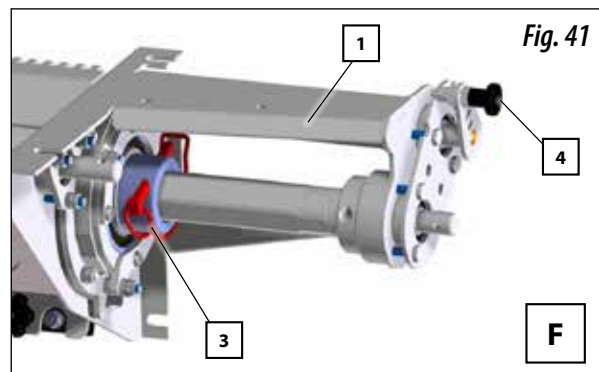

IN ORDER TO BE ABLE TO CHANGE THE POSITION OF THE LOCKING RING TO MICRODOSING, IT IS ESSENTIAL THAT THE SPINDLE (4) OF THE METERING UNIT CAN TURN FREELY AND THE HOPPER IS EMPTY.

- 1- Place the locking ring in **position F** (3, Fig. 41).
- 2- Turn the spindle (4, Fig. 41) to adjust the dosing.
- 3- Set the fan adjusting switch to **position F** (Fig. 42).
- 4- Fit the pinion gears as shown in the picture (Fig. 43).
- 5- Set the electrical controller to MICRO mode (see section 8. ELECTRICAL CONTROLLER).



WHEN MICRODOSING FINE SEEDS, DO NOT EXCEED NUMBER 25 IN ADJUSTING SCALE (1, FIG. 41)



OPEN THE SEED INLET TO THE METERING UNIT (FIG. 44).



ADJUSTMENTS

6.4 SEED DOSING ADJUSTMENTS

When using high quality certified seeds it is not enough to know the weight in kilograms distributed by the machine, as the final result of the harvest will depend on the number of plants which eventually ripen.

Every plant requires a certain amount of land from which nutrients will be absorbed. Therefore, both a low or an excessive plant density can be detrimental. To determine how many kilograms per hectare are to be sown, you should know the number of plants per square metre that are going to be planted. As a guidance, the recommended number of plants per square metre when sowing wheat or barley in un-irrigated land can be found in following table

AUTUMN	SPRING
Premature sowing, 200 plants per m ²	Premature sowing, 310 plants per m ²
Late sowing: 265 plants per m ²	Late sowing: 445 plants per m ²

Seed dosing should be adjusted to each terrain, depending on the: texture, fertilizing level, pluviometer results and sowing season, grain quality, germinating and tillering power, etc.

It should be taken into account that a seed's germinating power is variable and dependant on multiple factors. It can be experimentally calculated to be between 70% and 80%, which is practically equivalent to multiplying the number of grains to be sown by 1,43 or 1,25 respectively.



PLEASE NOTE THAT IN SPRING THERE IS LESS TILLERING SO MORE SEEDS SHOULD BE SOWN.



MAQUINARIA AGRÍCOLA SOLA, S.L., RECOMMENDS THAT THE FARMER SEEKS PROFESSIONAL ADVICE ABOUT THIS SUBJECT FROM A TECHNICAL SOWING CENTRE.

Next, we describe a practical method to determine the number of kilos per hectare to be distributed once we know how many plants per square metre we want to obtain.



- 1- Insert the "seed counter" into the seed sack to fill it (Fig. 45).
- 2- Wipe the seed counter with your hand to make sure that there is only one grain per slot (100 grains in total).

- 3- Do the same 10 more times to obtain 1000 grains.
- 4- Weigh 1000 grains with the precision scales.

We call the result in **GRAMS** the **OPERATIVE WEIGHT**. Once we know how many seeds per square metre we are going to sow, we should adjust the following kilograms per hectare in the dosing control:

$$\text{KILOGRAMS PER HECTARE} = \frac{(\text{grains per m}^2 \times \text{OPERATIVE WEIGHT})}{100}$$

6.5 PREVIOUS FLOW TEST

Once the seed dose has been adjusted (see section 6.3 DOSAGE and 6.4 SEED DOSING ADJUSTMENTS), a flow test should be performed to check that the dose to be distributed is the same than the dose indicated in the dosage tables..



TO PERFORM THIS TEST, IT IS ESSENTIAL TO SWITCH OFF THE TRACTOR'S ENGINE AND REMOVE THE STARTING KEY.

To perform the previous flow test in it is necessary to perform some previous operations:

- 1- FILL THE HOPPER with seeds or fertiliser.
- 2- COUPLE the machine to the tractor in a SLIGHTLY RAISED position (the sowing equipment must be not in contact with the ground).
- 3- UNLOCK the 2 LOCKS (1, Fig. 46) that secure the lid of the venturi injector sluice so that the lid can be opened.

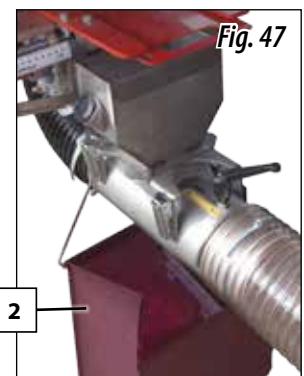
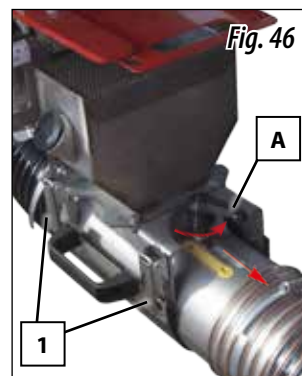

- 4- Set the handle (A, Fig. 46) of the venturi injector sluice in position "NO" (test position).
- 5- Place the provided sack (2, Fig. 47) or a container under the exit of the venturi injector sluice.

6- Next, place the crank (Fig. 48) in the drive wheel of the seed drill. Turn the wheel clockwise as many turns as indicated in the next table, which depends on the machine model.



MACHINE MODEL	NUMBER OF WHEEL TURNS
600	36,5
700	31,3

7- Accurately weigh the collected seeds

8- At a selected opening, you can obtain the kilograms per hectare distributed by the machine, by **MULTIPLYING THE WEIGHT BY 40**.

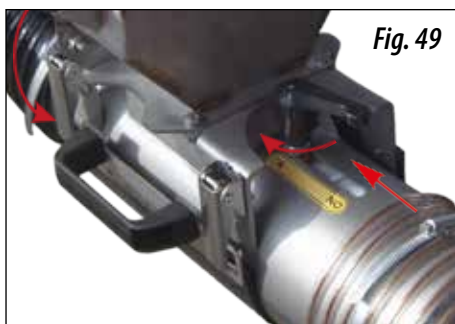

AFTER PERFORMING THE PREVIOUS FLOW TEST, CLOSE THE LID OF THE INJECTOR INJECTOR SLUICE, SET THE HANDLE IN POSITION "OK" AND LOCK IT (FIG. 49).



YOU MUST TURN THE WHEEL UNIFORMLY USING THE CRANK AT APPROXIMATELY ONE REVOLUTION PER SECOND, DEPENDING ON THE LAND'S CHARACTERISTICS, TYRE'S MANUFACTURER OR TYRE PRESSURE. IT IS HIGHLY RECOMMENDED TO PERFORM A FIELD TEST (SEE SECTION 6.6 DOSING FIELD TEST).



IF SEEDS SHOW EXCESS TREATMENT POWDER, FLOW CAN BE REDUCED, CONSEQUENTLY A SECOND CONTROL IS RECOMMENDED AFTER SOWING APPROXIMATELY THREE HOPPERS.

6.6 DOSING FIELD TEST

If differences exist between the test and the actual dose distribution (due to a very uneven or light soil, low pressurised tyres, etc.), an experimental test can be performed to determine the **REAL NUMBER OF TURNS** to be performed to the **DRIVE WHEEL**.



1- Using a tape measure, mark the distance (in metres) on the field's ground as shown in the table below:

MACHINE MODEL	METRES TO COVER
600	41,7
700	35,7

2- Make a mark on the tyre to count more easily the number of turns performed in the covered distance (Fig. 51).



3- Next, the seed drill in working position should cover that distance. In this way we obtain the actual number of turns to be performed in the previous flow test. By performing the test using this number of turns, we will know the actual kilograms per hectare distributed by the machine.



IF THERE IS A BIG DIFFERENCE BETWEEN THE NUMBER OF TURNS OBTAINED IN THE FIELD TEST AND THE NUMBER OF TURNS INDICATED BY THE MANUFACTURER (SECTION 6.5 PREVIOUS FLOW TEST), MAKE SURE THAT THE DRIVE WHEEL IS ALWAYS IN CONTACT WITH THE FLOATING WHEEL. IN CASE BOTH WHEELS ARE NOT IN CONTACT, OPERATE THE TENSIONER'S NUT (FIG. 51).

ADJUSTMENTS

6.7 HARROW

Some adjustments can be performed on the harrow so that it can adapt to all types of ground:

HEIGHT ADJUSTMENT

by operating the lower nut (1, fig. 52).

PRESSURE ADJUSTMENT

operating the tensioner's upper nut (2, fig. 52)

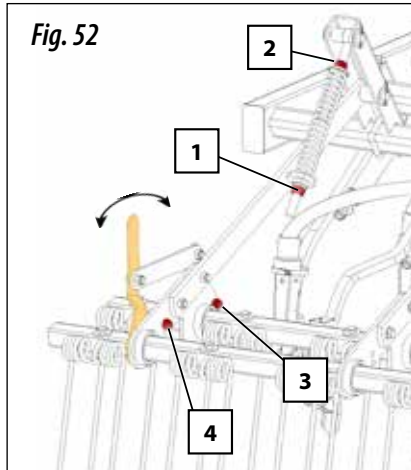

INCLINATION OF THE TINES

- 1- Loosen the nut (3, fig. 52).
- 2- Take out both the screw and the nut (4, fig. 52).
- 3- Pull the bar (yellow, fig. 52) and place both the screw and the nut in the hole (4, fig. 52).

6.8 LEVELLER

The work of the leveller is essential to obtain a uniform seed planting depth.

The leveller can be adjusted by operating the spindles (1, fig. 53), which modify height and pressure of leveller's three sections.



EARTH DRAGGED BY THE LEVELLER SHOULD NOT PROTRUDE OVER THE PLATE.

6.9 TRACK ERASER

To erase the tractor's tracks, the seed drill is equipped with track erasers with adjustable height.

To adjust the working depth, loosen the fixing screws, move the track erasers vertically and fix them to the new height by tightening the fixing screws.

6.10 HYDRAULIC TRACK MARKERS

Track markers can be adjusted in:

- **LENGTH** (horizontal spacing between disk and external element)
- **ORIENTATION** (penetration angle)



HIGH PRESSURE OIL MAY ESCAPE, PASS THROUGH THE SKIN AND INGRESS INTO THE BODY, CAUSING SERIOUS INJURIES. KEEP HYDRAULIC HOSE LINES IN GOOD CONDITION.



NEVER STAND UNDER THE TRACK DISCS OR WITHIN THEIR OPERATIONAL AREA.



IT IS ESSENTIAL TO FOLD THE TRACK MARKERS BEFORE FOLDING THE MACHINE FOR TRANSIT

6.10.1 ADJUSTING TRACK MARKER'S LENGTH

Track marker's arms are extensible. To calculate the horizontal spacing BETWEEN TRACK DISCS AND THE LAST METEERING UNIT (B, Fig. 55), use following formula:

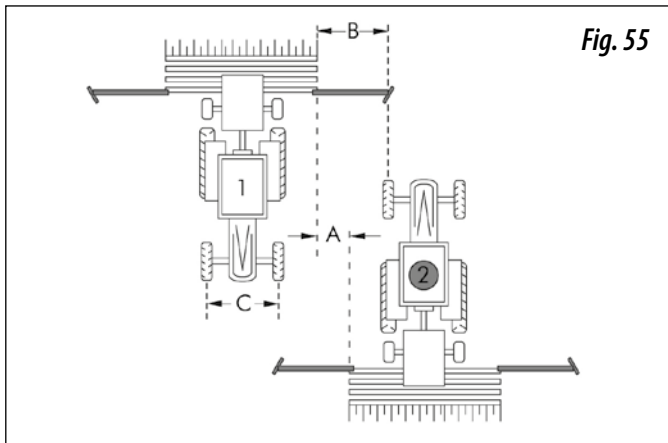

$$B = [A \times (\text{NUMBER OF ROWS} + 1) - C] / 2$$

WHERE:

- A** = row spacing
- B** = horizontal distance between track disc and the last metering unit.
- C** = track width of the tractor.



DISTANCE B CALCULATED USING THIS FORMULA IS THE ADJUSTING LENGTH UNTIL THE CENTER OF THE TRACTOR'S LEFT WHEEL (FIG. 55).



PERFORM THE CALCULATION WITH ALL MEASUREMENTS IN CENTIMETRES.

The distance of the track marker's disk can be adjusted following these steps:

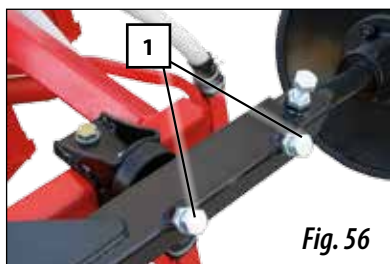

- 1- Loosen the two securing screws (1, Fig. 56).
- 2- Place the track disc at the distance B previously calculated (B= distance between the track disc and the last metering unit which is closer to the track marker).
- 3- Retighten the 2 securing screws (1, Fig. 56).

6.10.2 ADJUSTING TRACK DISC'S ORIENTATION

To adjust the track disc's orientation, follow these steps:

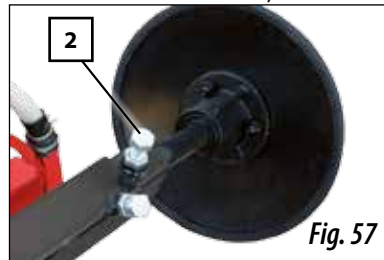

- 1- Loosen the securing screw (2, Fig. 57).
- 2- Adjust track disc's orientation so that it has the desirable impact on the ground.
- 3- Retighten the screw (2, Fig. 57).



IT IS NOT RECOMMENDED TO INCLINE THE TRACK DISCS TOO MUCH, THUS PREVENTING SERIOUS DAMAGE TO THE MACHINE.

6.11 INCLINATION OF THE FOLDING PARTS

At the connection point between the folding parts and the central chassis, there are adjustable stops which allow the folding parts' inclination angle to change.

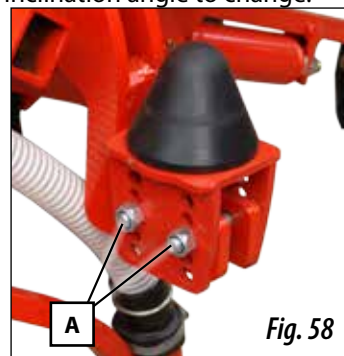

- 1- Loosen the two securing nuts (A, Fig. 58).
- 2- Remove the screws and nuts.
- 3- Adjust the folding stops.
- 4- Insert the screws and nuts in the new housing (3, Fig. 35).



DURING NORMAL SOWING CONDITIONS, THE FOLDING PARTS SHOULD BE SLIGHTLY LOWER THAN USUAL TO ADAPT TO TERRAIN IRREGULARITIES. FOR A BETTER ADAPTATION TO THE TERRAIN, SET THE HYDRAULIC CIRCUIT OF THE SOWING EQUIPMENT IN NEUTRAL POSITION.



IN VERY TILLED OR LOOSE LAND, AS WELL AS IN SOILS WITH HIGH HUMIDITY, THE FOLDING PARTS SHOULD BE LEVELLED TO STAY HORIZONTAL.

7- TYPES OF DISTRIBUTION



IMPORTANT: BEFORE THE WHEEL CONTROLLING THE DISTRIBUTOR'S TRANSMISSION STARTS TURNING, PLEASE ENSURE THAT THE FAN'S TURNING SPEED IS BETWEEN 4200 AND 4500. WHEN RAISING THE MACHINE, NEVER DECREASE THE FAN'S TURNING SPEED UNTIL THE WHEEL IS DETACHED FROM THE GROUND.

7.1 SEED DISTRIBUTION BY MECHANICAL FAN

To ensure that seeds are supplied to the tine coulters' sowing shoes, it is essential that the fan speed is between 4200 and 4500 rpm. For this purpose, the PTO shaft must be plugged into the 1000 rpm vent. If the turning speed is lower then some seeds are likely to remain in the seed hoses.



PLEASE NOTE THAT IF YOU WORK WITH THE MACHINE WHILE THE FAN IS OFF, SEEDS WILL BLOCK THE COLLECTING PIPE OF THE VENTURI INJECTOR SLUICE. IN CASE THIS HAPPENS, THE COLLECTOR SHOULD BE TAKEN OUT AND EMPTIED BEFORE USING THE SEED DRILL AGAIN.



IF THE FAN'S TURNING SPEED IS ABOVE OR BELOW 4200 AND 4500 RPM, THEN TURNING THE WHEEL THAT CONTROLS THE DISTRIBUTOR'S TRANSMISSION CAN CAUSE A BLOCKAGE INSIDE THE SEED HOSES.

7.2 SEED DISTRIBUTION BY HYDRAULIC FAN.

MACHINE TYPE	HYDRAULIC MOTOR	
	Absorbing capacity (cm ³)	Speed (rpm)
600	8	4500
700	8	4500

MACHINE TYPE	OIL SUPPLY		
	Minimum output pressure (bars)	Maximum return pressure (bars)	Oil flow (L/min)
600	160	1,5	40
700	160	1,5	40

CONNECTIONS

Connect the fan's small hydraulic hose line to a pressurised tractor control unit. The fan's 1/2" hydraulic hose line should be connected to a depressurised return tractor control unit.



IN THE RETURN LINE THE PRESSURE MUST BE A MAXIMUM OF 1,5 BAR. A HIGHER PRESSURE CAN CAUSE DAMAGE TO THE TRACTOR'S MOTOR.



Fig. 59

ADJUSTMENT

The fan's rpm is adjusted by regulating the tractor control unit.

The fan's turning speed must be adjusted to 4200 rpm or to 4500 rpm as shown in table above. If the turning speed is lower then some seeds are likely to remain in the seed hoses and block them.



IF OIL IS OVERHEATED DUE TO AN EXCESSIVE FLOW OR DUE TO LOW OIL SUPPLY, THEN AN ADDITIONAL OIL TANK WILL BE REQUIRED.



IF THE FLOW OF THE TRACTOR'S HYDRAULIC PUMP IS NOT HIGH ENOUGH IT WILL NOT BE ABLE TO POWER THE FAN'S MOTOR OR ACTIVATE THE OTHER ELEMENTS REQUIRED. IN THIS CASE AUXILIARY EQUIPMENT CONSISTING OF A HYDRAULIC PUMP FITTED ON THE TRACTOR'S UNIVERSAL JOINT SHAFT THAT DRIVES THE FAN'S HYDRAULIC MOTOR AS WELL AS A REFRIGERATED OIL TANK WILL BE REQUIRED. ASK THE MANUFACTURER.

8. ELECTRICAL CONTROLLER

8.1 FRONT PANEL DESCRIPTION

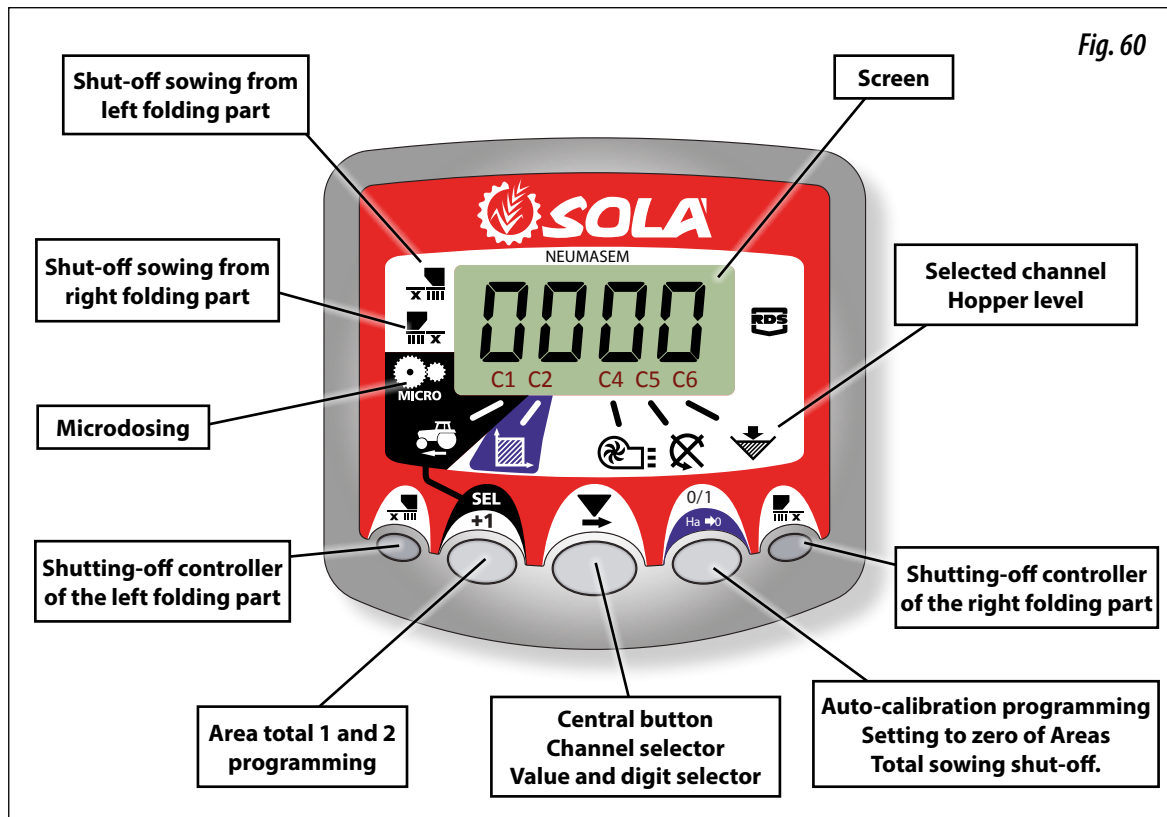

Fig. 60

The monitor provided comes programmed especially for your model of seed drill. The user will only need to observe the displayed values and no extra programming is required.

The monitor shows 6 different channels or readings, as well as 3 different arrows showing the states.

- C1** shows forward speed in m/sec.
- C2** shows two different hectares (for example on partial and one total hectare).
- C3** not in use.
- C4** shows the fan's rpm.
- C5** shows the turning speed of the distributor's axle's in rpm.
- C6** shows if the hopper's seed level is too low.

By default the forward movement speed is displayed on the monitor. When some abnormal readings are shown, the screen will display «Alarm» intermittently, the alarm will sound and the corresponding malfunction channel will be activated. The alarm will not stop until the malfunction is fixed.

To display a desired reading, press the central button and scroll to the required channel. After 10 seconds, the reading will change back to C1 again.

8.2 FORWARD SPEED – C1



Select a channel by using the central button. The alarm is activated when the speed is under 2.6 km/h and can be turned off using programming mode 2.

Calibrating the speed sensor

Theoretical calibration is achieved by entering a calibration factor in programming mode 2, as indicated in the following table.

MACHINE MODEL	6 metres	7 metres
CALIBRATION FACTOR	1,924	1,924

Selecting speed channel (C1)

- 1- Press  to switch to mode 1. While holding the button, press the central button  to modify the digit.
- 2- Hold the central button for some seconds to modify the flickering digit.
- 3- When the buttons are released, the monitor will return to its normal state.



PLEASE NOTE: THE IMPULSE NUMBER AUTO-CALIBRATION MODE IS MORE ACCURATE AND A FIELD TEST PERFORMANCE IS REQUIRED.

Auto-calibrating the speed sensor

- 1- Mark 100 metres.
- 2- Select channel 1 (speed).
- 3- Press and hold it while pressing . The screen will display "Auto". Release it.
- 4- Cover the 100 marked metres. The monitor will count the sensor's impulses.
- 5- After finishing, press again. By doing this, the monitor retains the impulse number in the memory.

8.3 TOTAL AREA / SEED DRILL WIDTH – C2

Two independent total areas can be marked.

Displaying the total area

- 1- Select channel 2.
- 2- Press to display total areas 1 and 2 on the screen. First, "tot. 1" will be displayed and immediately afterwards the value in Ha will be shown.

Setting to zero the total areas

- 1- Select channel 2.
- 2- Press to display.
- 3- Press and hold for more than 5 seconds.

Programming the working width

- 1- Select channel 2 of the area.
- 2- Press and hold for more than 5 seconds until the width value is displayed and, without releasing it, press the central button to modify the flickering digit.
- 3- Press and hold the flickering digit for more than 3 seconds to modify its value.
- 4- Release all buttons to return to the normal state.

Working in micro mode

When working with the distributor in the micro-dosing mode (for small hoppers and minimal doses), press and hold button for more than 3 seconds until the arrow indicating the micro mode is displayed. In this situation, the monitor will keep the speed and actual real working area.

Press and hold for more than 5 seconds until the indicating arrow disappears to resume normal position.

8.4 FRONT PANEL WITH TRAMLINING (OPTIONAL)

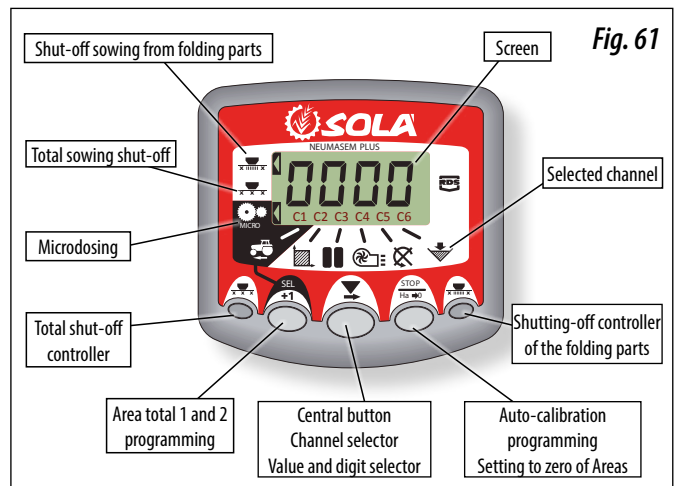

Fig. 61

The monitor provided comes programmed especially for your model of seed drill. The user will only need to observe the displayed values and no extra programming is required.

The monitor shows 6 different channels or readings, as well as 3 different arrows showing the states.

- C1** shows forward speed in m/sec.
- C2** shows two different hectares (for example on partial and one total hectare).
- C3** tramlining.
- C4** shows the fan's rpm.
- C5** shows the turning speed of the distributor's axle's in rpm.
- C6** shows if the hopper's seed level is too low.

8.5 TRAMLINING – C3

The displays defaults to the  channels after 10 seconds (unless the Area Total was selected).

There are 5 systems of tramlining – symmetric, asymmetric left, asymmetric right, 10 bout and 18 bout. The tramline bout is programmable from 1 to 15 in symmetric, asymmetric left and asymmetric right sequences.

Selection of asymmetric tramlining is denoted by a decimal point of the display between the current bout number on the left and the tramline bout number on the right. Left or right asymmetric tramlining is selected in the programming mode.

Manually advance the bout number

Press  to advance the current bout number by 1.

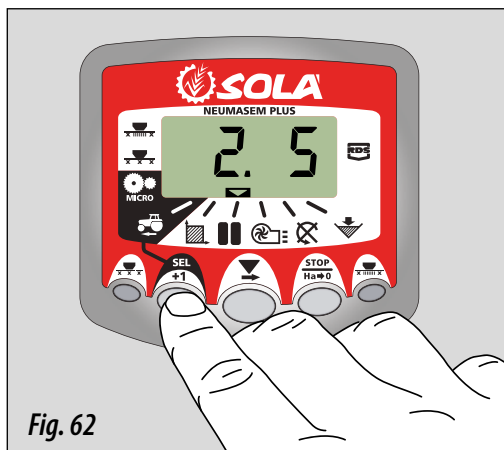



Fig. 62

Stopping the bout number

Press  to hold the current bout when the drill goes out of work. the display will flash 'STOP'.

Press  again to resume the normal bout sequence.

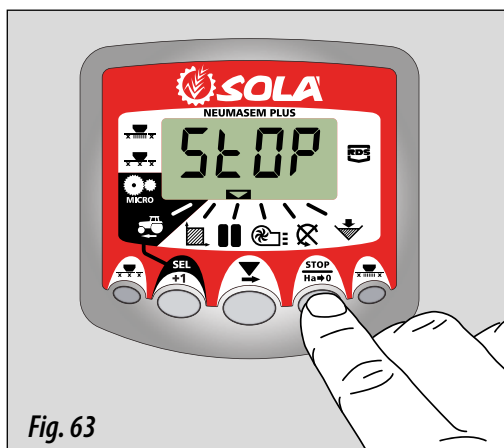

Fig. 63

Symmetric Tramlining Sequence

2+2 seed spouts are closed during the tramline bout only.

The instrument will beep once the beginning of the tramline bout, and the display will continue flashing for the duration of the bout.

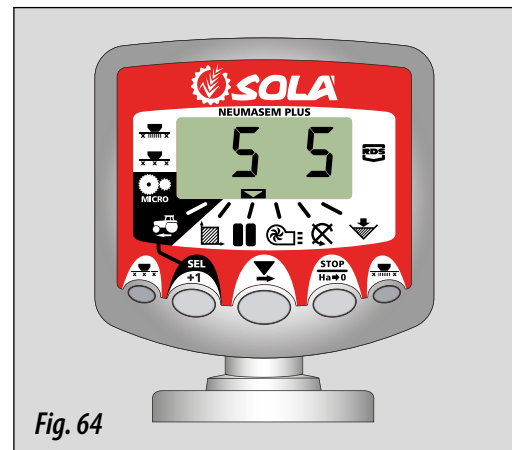

Fig. 64

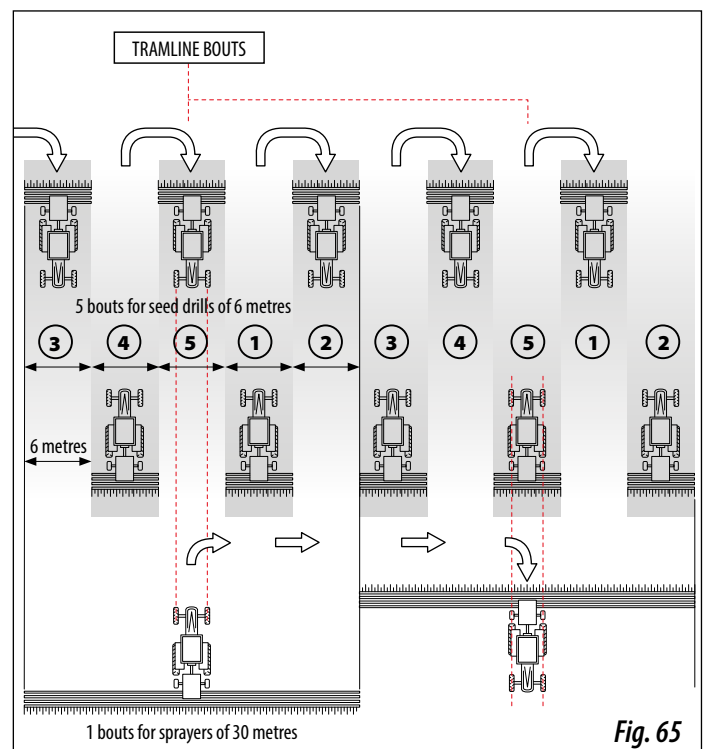

Fig. 65

Asymmetric Left Tramlining Sequence

Two seed spouts are closed on the left hand side of the drill on the tramline bouts.

The instrument will beep once the beginning of each tramline bout, and the display will continue flashing for the duration of the bout.

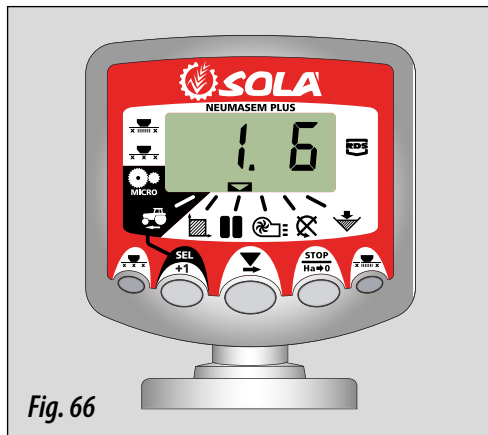

Fig. 66

Asymmetric Right Tramlining Sequence

Two seed spouts are closed on the right hand side of the drill on the tramline bouts.

The instrument will beep once the beginning of each tramline bout, and the display will continue flashing for the duration of the bout.

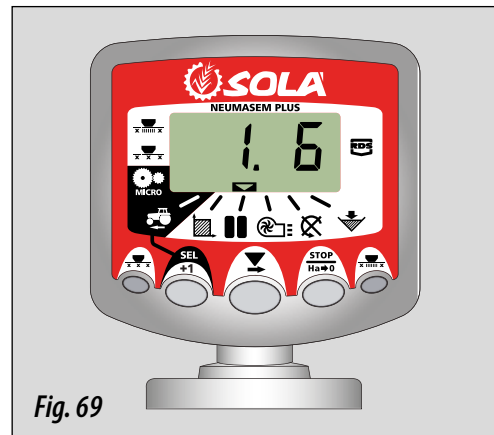

Fig. 69

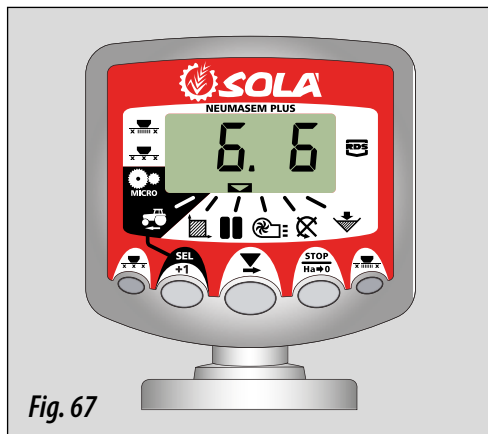

Fig. 67

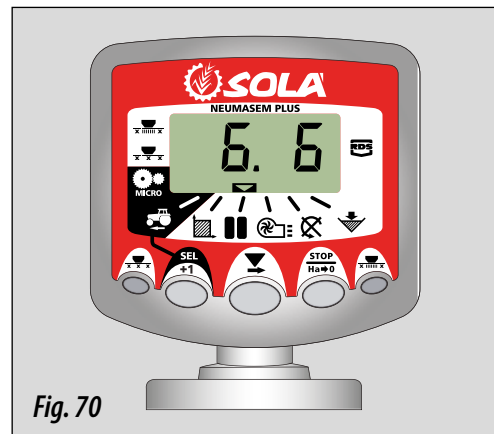

Fig. 70

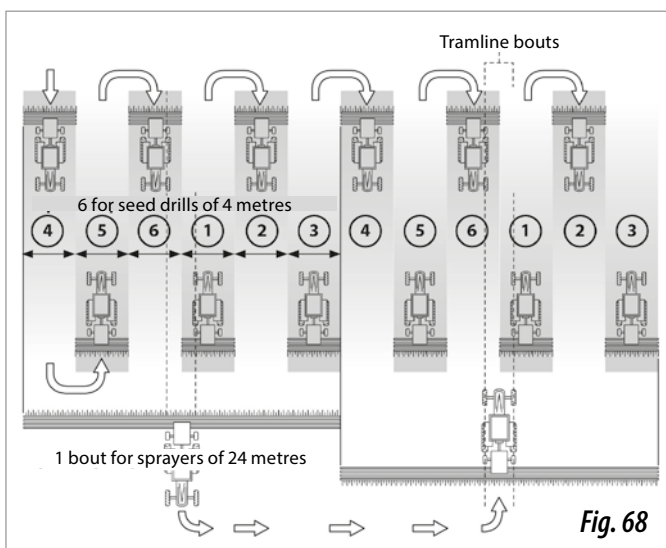

Fig. 68

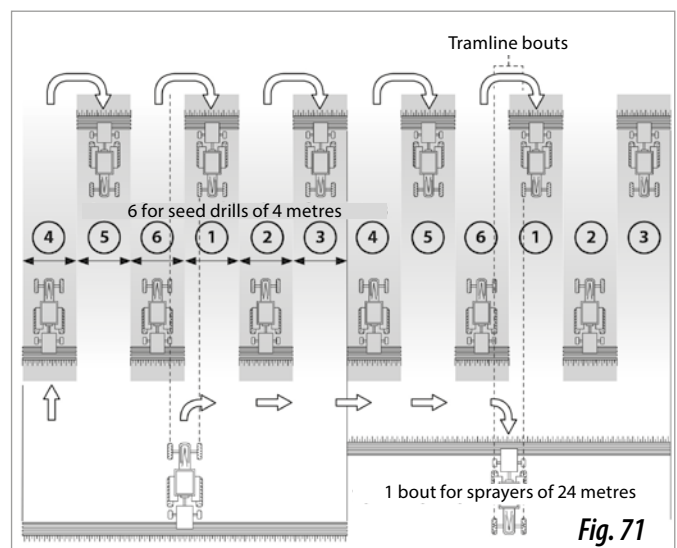

Fig. 71

10 Bout Tramlining Sequence

To be used in a combination of a 4 metre seed drill and a 10 metre sprayer, or a 8 metre seed drill and a 20 metre sprayer (2 + 2 left hand seed spouts are closed on bouts 4 and 7, and 2 + 2 right hand seed spouts are closed on bouts 2 and 9). Starting on bout 1 requires turning RIGHT at the end of the first bout.



NOTE TO TURN LEFT AT THE END OF THE FIRST BOUT, ADVANCE THE BOUT NUMBER TO 6 BEFORE STARTING TO SOW.

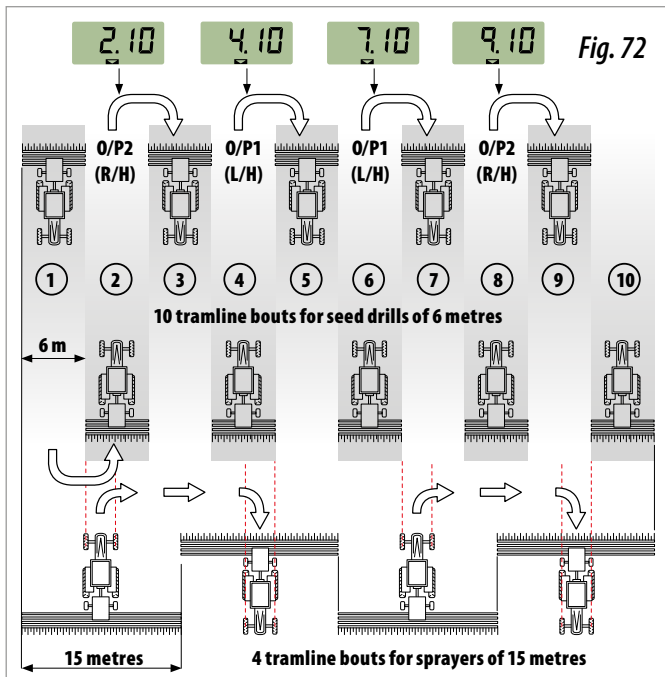

18 Bout Tramlining Sequence

To be used in a combination of a 4 metre drill and a 18 metre sprayer (2 + 2 left hand seed spouts are closed on bouts 3 and 16, and 2 + 2 right hand seed spouts are closed on bouts 7 and 12). Starting on bout 1 requires turning RIGHT at the end of the first bout.



NOTE: TO TURN LEFT AT THE END OF THE FIRST BOUT, ADVANCE THE BOUT NUMBER TO 10 BEFORE STARTING TO SOW.

The electronic controller will beep in each tramline bout.

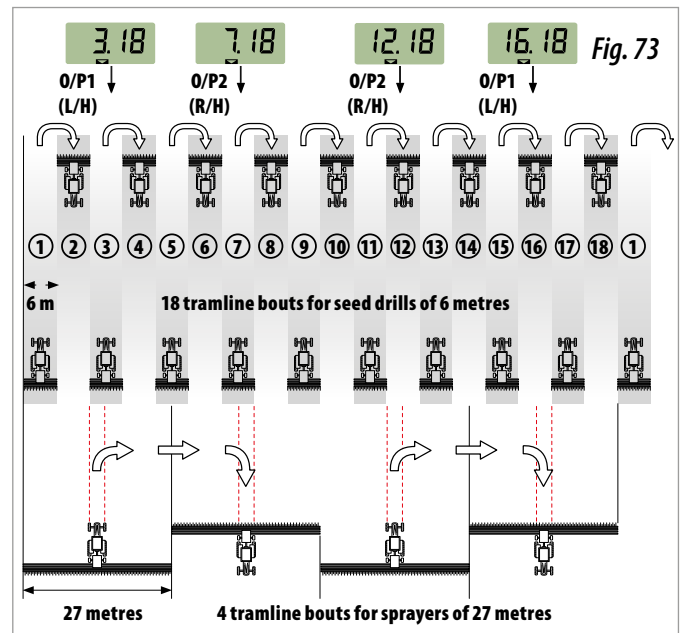

Selecting the Tramline Sequence

- 1- Select the channel.
- 2- Hold to enter programme mode 1.

After 5 seconds the first two digits flash, indicating the tramline sequence currently set:

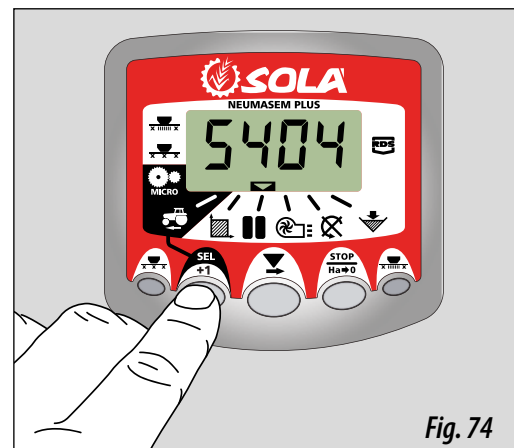

- 'SY' = Symmetric
- 'AL' = Asymmetric Left
- 'AR' = Asymmetric Right
- 'AS' = Special Asymmetric sequence with 10 bout and 18 bout.

- 3- Press and hold and at the same time to select the sequence.



ELECTRONICAL CONTROLLER

Setting the Tramline Bout

- 1- PRESS and RELEASE the  button to toggle between the tramline sequence and tramline bout number display. The 3rd and 4th digits flash indicating the tramline bout number currently set.
- 2- PRESS and RELEASE the  button to cycle the tramline bout from 1 to 15.

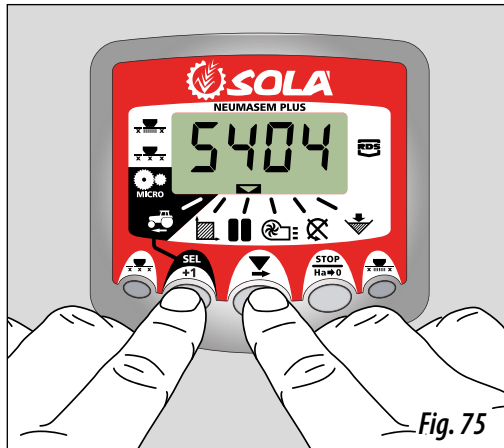

8.6 FAN RPM / FAN ALARMS – C4



To display the fan's speed in rpm

Select channel 4 using the central button .

Fan alarms



The fan's minimum turning speed can be programmed. Under 2 Km/h these alarms will deactivate.



Fan's minimum speed

- 1- Select channel 4.
- 2- Press and hold  button for more than 5 seconds.
- 3- Hold it and press  to change value and digits as explained in former cases. Default speed is 3800 rpm.
- 4- Release all buttons to resume the normal position

Selecting the fan's number of impulses per revolution (default value is set to 2).

PLEASE NOTE: FAN'S NUMBER OF IMPULSES PER REVOLUTION SHOULD ALWAYS BE 2. ONLY USE THIS PROGRAMMING MODE IN CASE OF MALFUNCTION.

- 1- TO SELECT PROGRAMMING MODE 2, DO THE FOLLOWING: WHILE SWITCHING ON THE ELECTRONICAL CONTROLLER USING REAR SWITCH, PRESS  IN MACHINE MODELS NEUMASEM OR  PIN MODEL NEUMASEM PLUS.

- 2- PRESS  IN MODEL NEUMASEM OR  IN NEUMASEM PLUS TO CHANGE THE CHANNEL AND SELECT CHANNEL 4 (FAN).

- 3- PRESS AND HOLD  TO MODIFY THE FLICKERING DIGIT (IT SHOULD ALWAYS BE 2).

- 4- RELEASE THE BUTTON TO CHANGE BACK TO NORMAL POSITION.

8.7 SEED SHAFT RPM – C5

Select channel 5 using the central button .

40 seconds after the seed shaft stops turning, an alarm beeps 5 times consecutively. If it remains still, this alarm will repeat every 30 seconds.

To turn off the beeping, switch off the screen and switch it on again. This alarm will deactivate under 2 Km/h.



The seed shaft's alarm can be deactivated by pressing the

button  for more than 5 seconds on the selected channel. The screen will display "Off". In this situation the alarm will not be activated even if the screen is switched off and on again.

8.8 HOPPER LOW LEVEL ALARM – C6

When the seed level is below the sensor, an alarm is activated and beeps 5 times consecutively. In this case the screen will display «ALA».

Activate and deactivate hopper level alarm

- 1- Select channel 6 using .
- 2- Press and hold  button and...
- 3- Press the central button to select «0» (alarm is off) or «1» (alarm is on).
- 4- Release the buttons to change back to the normal position.

8.9 TOTAL SOWING SHUT-OFF (OPTIONAL)

NEUMASEM control panel

Press the  button to lock the seed's exit. The screen will display the flickering text «CORT» (Fig. 76).

Press  button again to return to a normal working position and open the exits. The screen will display the flickering text «OPEN» (Fig. 77)

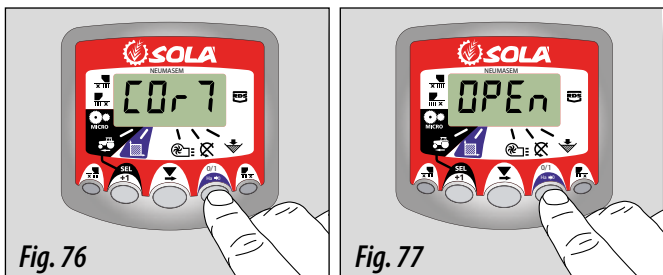

NEUMASEM PLUS control panel

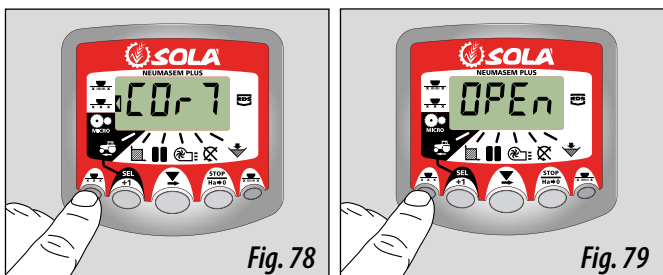

Press the  button to lock the seed's exit. The screen will display the indicating arrow, and the text «CORT» (Fig.78) will be displayed every two seconds.

Press the  button again to return to a normal working position and open the exits. The screen will display the flickering text «OPEN» (Fig. 79).





8.10 SHUT-OFF SOWING FROM FOLDING PARTS (OPTIONAL)

NEUMASEM control panel

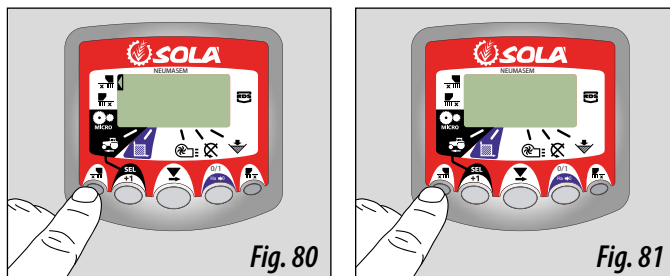

Press the  button to lock the exit part of the arms on the folding parts (left and right exits on the folding parts will be closed). The screen will display the indicating arrow (Fig. 80) and a flickering text. Press the  button again (Fig. 81) to change back to normal position and open the exits.



NEUMASEM control panel for INDEPENDENT FOLDING PARTS

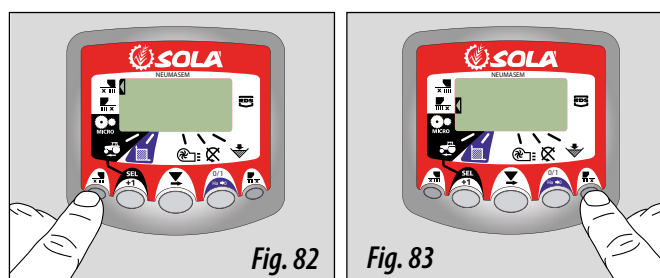

To lock the exit parts of the arms on the folding parts, press the  (button (to lock the left exit in the forward direction, Fig. 82) or press  (to lock the right exit in the forward direction, Fig. 83). The screen will display the indicating arrow.

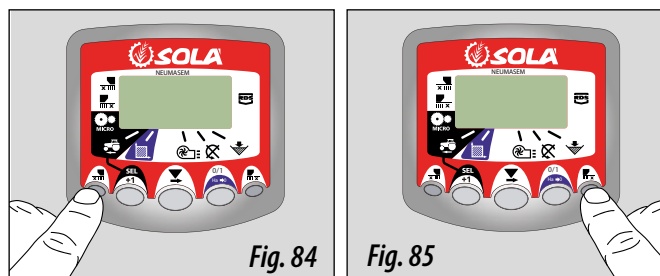

In order to change back to normal position and open the exits, press the button  or  again (fig. 84 or 85).



NEUMASEM PLUS control panel

Press the  button to lock the exit part of the arms on the folding parts . The screen will display the arrow indicating the selected mode (Fig. 86). Press the  (button again to change back to normal position and open the exits (Fig. 87).

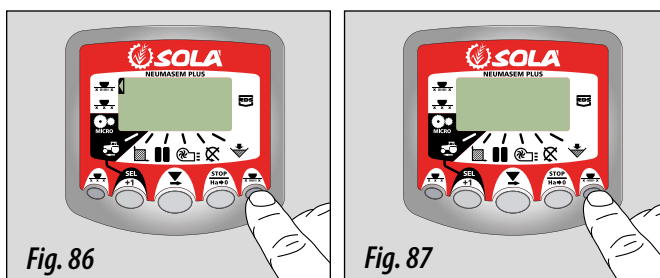

9- MAINTENANCE



IN CASE OF MALFUNCTION, STOP THE SEED DRILL IMMEDIATELY AND REMOVE THE IGNITION KEY. LEAVE THE TRACTOR AND VISUALLY INSPECT AND EVALUATE THE EXTENT OF THE PROBLEM. PERFORM THE REQUIRED OPERATIONS ON THE SEED DRILL BEFORE RESTARTING IT.



MAINTENANCE OPERATIONS MUST BE PERFORMED IN PROPERLY EQUIPPED GARAGES BY QUALIFIED PERSONNEL.



NO REPAIRS SHOULD BE PERFORMED WITHOUT THE NECESSARY SKILLS AND KNOWLEDGE. IT IS ESSENTIAL THAT THE INSTRUCTIONS DETAILED IN THIS MANUAL ARE STRICTLY FOLLOWED. IF THESE INSTRUCTIONS ARE MISSING, PLEASE CONTACT THE SEED DRILL'S PROVIDER OR QUALIFIED PERSONNEL.



IN ORDER TO PERFORM MAINTENANCE OR REPAIR OPERATIONS TO THE SEED DRILL, IT IS ESSENTIAL TO USE PROPER PERSONAL PROTECTIVE EQUIPMENT (PPE): SAFETY BOOTS AND GLOVES, HEARING PROTECTION, DUST MASK AND PROTECTIVE GLASSES).



IT IS RECOMMENDED TO AVOID WEARING LOOSE CLOTHING SINCE IT MAY BECOME TANGLED WITH THE SEED DRILL'S MOVING PARTS.

Before performing any task on the machine, it is essential to take into account the following factors:

- Maintaining or repairing the seed drill should be performed on a flat and compact ground. Before starting any of these tasks, the tractor's engine must be turned off and the ignition key removed.
- The chosen device to raise the seed drill needs to be appropriate for the operations to be performed. Please ensure that all safety regulations are observed.
- Always use appropriate protective equipment for any task to be performed.
- In case compressed air is used to clean the seed drill, or an airbrush is used to paint any seed drill's part, you are required to wear protective glasses and mask.
- If any operation needs to be performed on a part of the machine which is at more than 1,5 metres height from the ground, check if it is possible to reach this part using the seed drill's access points (seed drill's access ladder). If not possible, use either a ladder or a platform which is in accordance with the current safety regulations.

- Prolonged and/or repetitive skin contact with fuel and lubricants is harmful. In case these products come accidentally into contact with the eyes or other sensitive parts, wash well the affected parts with clean water. In case of ingestion, contact the medical services immediately.

9.1 CHECKING FREQUENCY

The frequency of the checks indicated below is provided as a guideline. It may vary depending on machine application and use, environment, temperature, weather conditions, etc.

- BEFORE STARTING THE SOWING SEASON

- Check the general operation of the seed drill. Perform this check without any seeds inside the hopper.
- Check that the plastic components of the seed drill are in good condition. The wear of this material due to natural ageing or to the presence of rodents causes damages to these components.
- Check that the mechanical components are in good condition and not rusty.
- Clean the parts of the seed drill which are permanently in contact with seeds, such as hoppers and metering units.
- Check that the signal lamps work properly.
- Check that the unions and the ducts of the hydraulic system do not show oil leaks.

- PERIODICALLY

- Before washing the seed drill with water, check that no seeds or fertilizer are inside the hoppers or the metering units. After washing the machine, turn on the fan for some minutes in order to remove the moisture from the metering units and the suction system.
- Check that all the screws are in good condition, especially the ones which are in contact with the ground. Tighten every single screw and bolt.
- Check that the metering units and the suction system do not contain any residue (such as seed or fertilizer residue, dust, etc). Residue accumulation may damage the suction system.

- END OF SOWING SEASON

- Wash the seed drill well with a lot of water, making sure that no seeds, fertilizer or other products remain inside the hoppers, metering units or ducts. Wash especially the parts of the seed drill which are in contact with chemical products.
- Properly lubricate the moving parts of the seed drill (see section 9.4 GREASING AND LUBRICATION).
- Repaint any metallic component which has lost its paint due to wear.
- To store the seed drill properly, cover it with tarpaulin and keep it in a dry place.
- Thoroughly check all components of the seed drill and replace the ones which are damaged or worn.



KEEP THE SOWING EQUIPMENT CLEAN. THE ACCUMULATION OF EARTH, STONES, GRASS, ETC. MAY BLOCK THE SOWING DUCTS.

A careful maintenance of the seed drill ensures proper functioning and long service life of the machine.



BEFORE PERFORMING THESE OPERATIONS, THE SEED DRILL'S ENGINE MUST BE TURNED OFF AND THE IGNITION KEY REMOVED.

The next table shows the maintenance operations to be performed on the machine along with their **guidance frequency**.

SEED DRILL'S PART	TASK TO BE PERFORMED	NUMBER OF HOURS			
		20	50	100	500
Machine's components	Greasing of all the components	X	X		
Wheels	Check of the tyre pressure			X	
	Check the condition of the joint of the floating wheels.				X
Chain transmissions	Lubrication of the transmission chains		X		
	Adjusting the transmission chains' tension				X
Distribuidor	Lubrication of the transmission chains			X	

9.2 SCREWS

All unions of the seed drill must be checked and, if necessary, retightened.



AFTER THE FIRST 10 HOURS OF WORK, TIGHTEN THE SCREWS THAT SECURE THE METERING UNITS, THE THREE POINT LINKAGE, THE WHEELS AND THE TRACK MARKERS' SUPPORTS.

9.3 CLEANING THE SEED DRILL

The seed drill should be washed using a water jet or preferably using a high-pressure cleaner. Let the seed drill dry before greasing or lubricating to prevent the metallic parts from rusting. After washing the machine, turn on the fan for some minutes in order to remove the moisture from the metering units and the suction system. It may be possible that, while working, some foreign bodies are stuck in some parts of the machine. Remove any foreign body and check if any damage has been caused to the seed drill.



WHEN CLEANING WITH COMPRESSED AIR, USE PROPER PERSONAL PROTECTIVE EQUIPMENT (PPE) (SEE SECTION 9. MAINTENANCE).

9.4 GREASING AND LUBRICATION

Every non-painted metallic component of the seed drill is exposed to atmospheric and weather conditions, which may oxidize them. For this reason, it is important to grease and lubricate these components.

Attached to specific parts of the seed drill, you will find adhesives with symbols to indicate the parts to be GREASED (Fig. 88) or the points to be LUBRICATED (Fig. 89).

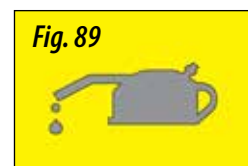
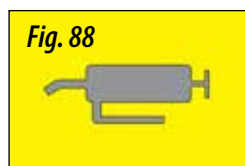

BEFORE LUBRICATING OR GREASING, WASH THE SEED DRILL TO REMOVE EARTH RESIDUES ATTACHED TO THE MACHINE (see section 9.1 CHECKING FREQUENCY).



DO NOT GREASE OR LUBRICATE THE SEED METERING UNIT OR THE FERTILISER METERING UNIT.



SOME PARTS OF THE MACHINE NEED TO BE GREASED EVERY 20 OR 50 WORKING HOURS. NOT OBSERVING THESE GREASING RULES MAY RESULT IN DAMAGE TO THE SEED DRILL.



TO GREASE THESE PARTS, ALWAYS USE SOLID CALCIUM GREASE.



ALWAYS USE HIGH PERFORMANCE CHAIN OIL TO GET A RELIABLE LUBRICATION.

The following parts of the seed drill should be **GREASED**:

- Track markers.
- The bushings from the drive wheel and the depth adjustment wheel.
- Joints.
- Each component of the transmission.



TO APPLY THE GREASE, ACROSS THE POINTS OF GREASING.

LUBRICATE the transmission chains. To gain access to the chain, first remove the protective lid.

DOSAGE TABLES

9.5 TYRE PRESSURE

Before starting working with the seed drill, check that the tyre pressure is correct.

In general use and especially when working on irregularly tilled terrains, it is recommended to use a slightly lower pressure to absorb the ground's irregularities and get a higher regularity in sowing.

TYRE TYPE	DESCRIPTION	AIR PRESSURE (bar)
550/60-22.5	Floating wheel	3,3
3.5 - 8	Drive wheel	2,1
18x7" - 8" 14PR	Depth adjustment wheel	3,75

10. DOSAGE TABLES

Values in the dosage tables are in Kg/Ha that will be distributed by the seed drill depending on the metering unit adjustments (see section 6.3 DOSAGE).



FOR PRECISION SOWING, FOLLOW DOSING PROCESS DESCRIBED IN SECTION 6 OF THIS MANUAL.



INDICATED QUANTITIES SHOWN IN THE FOLLOWING TABLES SHOULD BE CONSIDERED FOR GUIDANCE ONLY, FORESEEN FLOWS CAN VARY DEPENDING ON THE ACCIDENTAL PRESENCE OF DISINFECTING PRODUCTS, UNEVEN SEED SIZE, DENSITY, HUMIDITY, ETC.

10.1 DOSAGE TABLES (FOR 1 METERING UNIT)

MICRO-6 METRES								
FINE SEED	RAPE		RED CLOVER		GRASS		TURNIP	
Specific Weight (Kg/l)	0,65		0,77		0,39		0,7	
Position in the graduated sector	FINE SEED (Kg/Ha)							
2,5	0,89	0,45	1,06	0,53	-	-	0,96	0,48
5	1,78	0,89	2,11	1,06	-	-	1,92	0,96
7,5	2,68	1,34	3,17	1,59	1,61	0,80	2,88	1,44
10	3,57	1,78	4,23	2,11	2,14	1,07	3,84	1,92
12,5	4,07	2,03	4,82	2,41	2,44	1,22	4,38	2,19
15	4,88	2,44	5,78	2,89	2,93	1,46	5,26	2,63
17,5	5,70	2,85	6,75	3,37	3,42	1,71	6,13	3,07
20	6,51	3,25	7,71	3,86	3,91	1,95	7,01	3,51
22,5	7,82	3,91	9,27	4,63	4,69	2,35	8,43	4,21
25	8,69	4,35	10,30	5,15	5,22	2,61	9,36	4,68
POSITION	N	F	N	F	N	F	N	F

MICRO-7 METRES								
FINE SEED	RAPE		RED CLOVER		GRASS		TURNIP	
Specific Weight (Kg/l)	0,65		0,77		0,39		0,7	
Position in the graduated sector	FINE SEED (Kg/Ha)							
2,5	0,77	0,38	0,91	0,45	-	-	0,82	0,41
5	1,53	0,77	1,81	0,91	-	-	1,65	0,82
7,5	2,30	1,15	2,72	1,36	1,38	0,69	2,47	1,24
10	3,06	1,53	3,63	1,81	1,84	0,92	3,30	1,65
12,5	3,49	1,74	4,13	2,07	2,09	1,05	3,76	1,88
15	4,19	2,09	4,96	2,48	2,51	1,26	4,51	2,25
17,5	4,88	2,44	5,79	2,89	2,93	1,47	5,26	2,63
20	5,58	2,79	6,61	3,31	3,35	1,67	6,01	3,01
22,5	6,71	3,35	7,95	3,97	4,03	2,01	7,23	3,61
25	7,45	3,73	8,83	4,42	4,47	2,24	8,03	4,01
POSITION	N	F	N	F	N	F	N	F

When the dose to be planted (Kg/Ha) is very small (position in the graduated sector <=10), it is possible to obtain a more uniform planting by means of microdosing, even with a regular range of seeds (cereal and big seeds).

6 METRES										
NORMAL SEED	WHEAT	RYE	BARLEY	OATS	BEANS	PEAS	LUPIN	CAROB	CORN	GRASS
Specific Weight (Kg/l)	0,77	0,74	0,68	0,5	0,85	0,81	0,76	0,83	0,79	0,36
Position in the graduated sector	SEMILLA NORMAL (kg/ha)									
5	-	-	-	-	-	-	-	-	-	-
10	32,6	31,4	28,8	21,2	36,0	34,3	32,2	35,2	33,5	-
15	49,0	47,1	43,2	31,8	54,0	51,5	48,3	52,8	50,2	22,9
20	65,3	62,7	57,6	42,4	72,1	68,7	64,4	70,4	67,0	30,5
25	81,6	78,4	72,1	53,0	90,1	85,8	80,5	88,0	83,7	38,2
30	98,5	94,6	87,0	63,9	108,7	103,6	97,2	106,1	101,0	46,0
35	114,9	110,4	101,5	74,6	126,8	120,9	113,4	123,8	117,9	53,7
40	131,3	126,2	115,9	85,3	144,9	138,1	129,6	141,5	134,7	-
45	147,7	142,0	130,4	95,9	163,1	155,4	145,8	159,2	151,5	-
50	164,1	157,7	144,9	106,6	181,2	172,6	162,0	176,9	168,4	-
55	174,9	168,1	154,5	113,6	193,1	184,0	172,6	188,6	179,5	-
60	190,8	183,4	168,5	123,9	210,6	200,7	188,3	205,7	195,8	-
65	206,7	198,7	182,6	134,2	228,2	217,5	204,0	222,8	212,1	-
70	222,6	214,0	196,6	144,6	245,8	234,2	219,7	240,0	228,4	-
75	238,5	229,2	210,6	154,9	263,3	250,9	235,4	257,1	244,7	-
80	252,5	242,7	223,0	164,0	278,7	265,6	249,2	272,2	259,1	-
85	268,3	257,8	236,9	174,2	296,2	282,2	264,8	289,2	275,3	-
90	284,1	273,0	250,9	184,5	313,6	298,8	280,4	306,2	291,4	-
95	299,9	288,2	264,8	194,7	331,0	315,4	296,0	323,2	307,6	-
100	315,6	303,3	278,7	205,0	348,4	332,0	311,5	340,2	323,8	-
105	332,8	319,8	293,9	216,1	367,4	350,1	328,5	358,7	341,4	-
110	348,6	335,1	307,9	226,4	384,9	366,8	344,1	375,8	357,7	-
115	364,5	350,3	321,9	236,7	402,4	383,4	359,8	392,9	374,0	-
120	380,3	365,5	335,9	247,0	419,9	400,1	375,4	410,0	390,2	-
125	396,2	380,7	349,9	257,3	437,3	416,8	391,0	427,1	406,5	-
130	412,0	396,0	363,9	267,6	454,8	433,4	406,7	444,1	422,7	-

7 METRES										
NORMAL SEED	WHEAT	RYE	BARLEY	OATS	BEANS	PEAS	LUPIN	CAROB	CORN	GRASS
Specific Weight (Kg/l)	0,77	0,74	0,68	0,5	0,85	0,81	0,76	0,83	0,79	0,36
Position in the graduated sector	SEMILLA NORMAL (kg/ha)									
5	-	-	-	-	-	-	-	-	-	-
10	28,0	26,9	24,7	18,2	30,9	29,4	27,6	30,2	28,7	-
15	42,0	40,3	37,1	27,3	46,3	44,2	41,4	45,3	43,1	19,6
20	56,0	53,8	49,4	36,4	61,8	58,9	55,3	60,3	57,4	26,2
25	70,0	67,2	61,8	45,4	77,2	73,6	69,1	75,4	71,8	32,7
30	84,4	81,2	74,6	54,8	93,2	88,8	83,3	91,0	86,6	39,5
35	98,5	94,7	87,0	64,0	108,8	103,6	97,2	106,2	101,1	46,1
40	112,6	108,2	99,4	73,1	124,3	118,4	111,1	121,4	115,5	-
45	126,7	121,7	111,9	82,2	139,8	133,2	125,0	136,5	130,0	-
50	140,7	135,3	124,3	91,4	155,4	148,0	138,9	151,7	144,4	-
55	150,0	144,2	132,5	97,4	165,6	157,8	148,1	161,7	153,9	-
60	163,6	157,3	144,5	106,3	180,6	172,1	161,5	176,4	167,9	-
65	177,3	170,4	156,6	115,1	195,7	186,5	175,0	191,1	181,9	-
70	190,9	183,5	168,6	124,0	210,7	200,8	188,4	205,8	195,9	-
75	204,5	196,6	180,6	132,8	225,8	215,2	201,9	220,5	209,9	-
80	216,5	208,1	191,2	140,6	239,0	227,8	213,7	233,4	222,2	-
85	230,1	221,1	203,2	149,4	254,0	242,0	227,1	248,0	236,0	-
90	243,6	234,1	215,1	158,2	268,9	256,3	240,4	262,6	249,9	-
95	257,1	247,1	227,1	167,0	283,8	270,5	253,8	277,2	263,8	-
100	270,7	260,1	239,0	175,8	298,8	284,7	267,2	291,8	277,7	-
105	285,4	274,3	252,0	185,3	315,0	300,2	281,7	307,6	292,8	-
110	299,0	287,3	264,0	194,1	330,0	314,5	295,1	322,3	306,7	-
115	312,6	300,4	276,0	203,0	345,0	328,8	308,5	336,9	320,7	-
120	326,2	313,4	288,0	211,8	360,0	343,1	321,9	351,6	334,6	-
125	339,7	326,5	300,0	220,6	375,0	357,4	335,3	366,2	348,6	-
130	353,3	339,6	312,0	229,4	390,0	371,7	348,7	380,9	362,5	-

10.2 DOSAGE TABLES (FOR 2 METERING UNITS)

MICRO-6 METRES										MICRO-7 METRES									
FINE SEED	RAPE		RED CLOVER		GRASS		TURNIP			FINE SEED	RAPE		RED CLOVER		GRASS		TURNIP		
Specific Weight (Kg/l)	0,65		0,77		0,39		0,7			Specific Weight (Kg/l)	0,65		0,77		0,39		0,7		
Position in the graduated sector	FINE SEED (Kg/Ha)									Position in the graduated sector	FINE SEED (Kg/Ha)								
2,5	1,78	0,9	2,12	1,06	-	-	1,92	0,96		2,5	1,54	0,76	1,82	0,9	-	-	1,64	0,82	
5	3,56	1,78	4,22	2,12	-	-	3,84	1,92		5	3,06	1,54	3,62	1,82	-	-	3,3	1,64	
7,5	5,36	2,68	6,34	3,18	3,22	1,6	5,76	2,88		7,5	4,6	2,3	5,44	2,72	2,76	1,38	4,94	2,48	
10	7,14	3,56	8,46	4,22	4,28	2,14	7,68	3,84		10	6,12	3,06	7,26	3,62	3,68	1,84	6,6	3,3	
12,5	8,14	4,06	9,64	4,82	4,88	2,44	8,76	4,38		12,5	6,98	3,48	8,26	4,14	4,18	2,1	7,52	3,76	
15	9,76	4,88	11,56	5,78	5,86	2,92	10,52	5,26		15	8,38	4,18	9,92	4,96	5,02	2,52	9,02	4,5	
17,5	11,4	5,7	13,5	6,74	6,84	3,42	12,26	6,14		17,5	9,76	4,88	11,58	5,78	5,86	2,94	10,52	5,26	
20	13,02	6,5	15,42	7,72	7,82	3,9	14,02	7,02		20	11,16	5,58	13,22	6,62	6,7	3,34	12,02	6,02	
22,5	15,64	7,82	18,54	9,26	9,38	4,7	16,86	8,42		22,5	13,42	6,7	15,9	7,94	8,06	4,02	14,46	7,22	
25	17,38	8,7	20,6	10,3	10,44	5,22	18,72	9,36		25	14,9	7,46	17,66	8,84	8,94	4,48	16,06	8,02	
POSITION	N	F	N	F	N	F	N	F		POSITION	N	F	N	F	N	F	N	F	

PREVIOUS FLOW TEST	
SEED DRILL	WHEEL TURNS
600	36,5
700	31,3

When the dose to be planted (Kg/Ha) is very small (position in the graduated sector ≤ 10), it is possible to obtain a more uniform planting by means of microdosing, even with a regular range of seeds (cereal and big seeds).

6 METRES										
NORMAL SEED	WHEAT	RYE	BARLEY	OATS	BEANS	PEAS	LUPIN	CAROB	CORN	GRASS
Specific Weight (Kg/l)	0,77	0,74	0,68	0,5	0,85	0,81	0,76	0,83	0,79	0,36
Position in the graduated sector	SEMILLA NORMAL (kg/ha)									
5	-	-	-	-	-	-	-	-	-	-
10	65,2	62,8	57,6	42,4	72	68,6	64,4	70,4	67	-
15	98	94,2	86,4	63,6	108	103	96,6	105,6	100,4	45,8
20	130,6	125,4	115,2	84,8	144,2	137,4	128,8	140,8	134	61
25	163,2	156,8	144,2	106	180,2	171,6	161	176	167,4	76,4
30	197	189,2	174	127,8	217,4	207,2	194,4	212,2	202	92
35	229,8	220,8	203	149,2	253,6	241,8	226,8	247,6	235,8	107,4
40	262,6	252,4	231,8	170,6	289,8	276,2	259,2	283	269,4	-
45	295,4	284	260,8	191,8	326,2	310,8	291,6	318,4	303	-
50	328,2	315,4	289,8	213,2	362,4	345,2	324	353,8	336,8	-
55	349,8	336,2	309	227,2	386,2	368	345,2	377,2	359	-
60	381,6	366,8	337	247,8	421,2	401,4	376,6	411,4	391,6	-
65	413,4	397,4	365,2	268,4	456,4	435	408	445,6	424,2	-
70	445,2	428	393,2	289,2	491,6	468,4	439,4	480	456,8	-
75	477	458,4	421,2	309,8	526,6	501,8	470,8	514,2	489,4	-
80	505	485,4	446	328	557,4	531,2	498,4	544,4	518,2	-
85	536,6	515,6	473,8	348,4	592,4	564,4	529,6	578,4	550,6	-
90	568,2	546	501,8	369	627,2	597,6	560,8	612,4	582,8	-
95	599,8	576,4	529,6	389,4	662	630,8	592	646,4	615,2	-
100	631,2	606,6	557,4	410	696,8	664	623	680,4	647,6	-
105	665,6	639,6	587,8	432,2	734,8	700,2	657	717,4	682,8	-
110	697,2	670,2	615,8	452,8	769,8	733,6	688,2	751,6	715,4	-
115	729,0	700,6	643,8	473,4	804,7	766,8	719,5	785,8	747,9	-
120	760,7	731,0	671,8	493,9	839,7	800,2	750,8	819,9	780,4	-
125	792,4	761,5	699,8	514,5	874,7	833,5	782,1	854,1	812,9	-
130	824,1	792,0	727,7	535,1	909,7	866,9	813,4	888,3	845,5	-

7 METRES										
NORMAL SEED	WHEAT	RYE	BARLEY	OATS	BEANS	PEAS	LUPIN	CAROB	CORN	GRASS
Specific Weight (Kg/l)	0,77	0,74	0,68	0,5	0,85	0,81	0,76	0,83	0,79	0,36
Position in the graduated sector	SEMILLA NORMAL (kg/ha)									
5	-	-	-	-	-	-	-	-	-	-
10	56	53,8	49,4	36,4	61,8	58,8	55,2	60,4	57,4	-
15	84	80,6	74,2	54,6	92,6	88,4	82,8	90,6	86,2	39,2
20	112	107,6	98,8	72,8	123,6	117,8	110,6	120,6	114,8	52,4
25	140	134,4	123,6	90,8	154,4	147,2	138,2	150,8	143,6	65,4
30	168,8	162,4	149,2	109,6	186,4	177,6	166,6	182	173,2	79
35	197	189,4	174	128	217,6	207,2	194,4	212,4	202,2	92,2
40	225,2	216,4	198,8	146,2	248,6	236,8	222,2	242,8	231	-
45	253,4	243,4	223,8	164,4	279,6	266,4	250	273	260	-
50	281,4	270,6	248,6	182,8	310,8	296	277,8	303,4	288,8	-
55	300	288,4	265	194,8	331,2	315,6	296,2	323,4	307,8	-
60	327,2	314,6	289	212,6	361,2	344,2	323	352,8	335,8	-
65	354,6	340,8	313,2	230,2	391,4	373	350	382,2	363,8	-
70	381,8	367	337,2	248	421,4	401,6	376,8	411,6	391,8	-
75	409	393,2	361,2	265,6	451,6	430,4	403,8	441	419,8	-
80	433	416,2	382,4	281,2	478	455,6	427,4	466,8	444,4	-
85	460,2	442,2	406,4	298,8	508	484	454,2	496	472	-
90	487,2	468,2	430,2	316,4	537,8	512,6	480,8	525,2	499,8	-
95	514,2	494,2	454,2	334	567,6	541	507,6	554,4	527,6	-
100	541,4	520,2	478	351,6	597,6	569,4	534,4	583,6	555,4	-
105	570,8	548,6	504	370,6	630	600,4	563,4	615,2	585,6	-
110	598	574,6	528	388,2	660	629	590,2	644,6	613,4	-
115	625,1	600,8	552,1	405,9	690,1	657,6	617,0	673,8	641,4	-
120	652,3	626,9	576,1	423,6	720,1	686,2	643,8	703,1	669,2	-
125	679,5	653,0	600,1	441,2	750,1	714,8	670,7	732,4	697,1	-
130	706,7	679,1	624,1	458,9	780,1	743,4	697,5	761,7	725,0	-

10.3 MICRO-FERTILISER TABLE (OPTIONAL)

This micro-fertiliser equipment has several metering units. Next table show the values to be distributed by them.

They are adjusted turning the adjusting knob (1, Fig. 90).

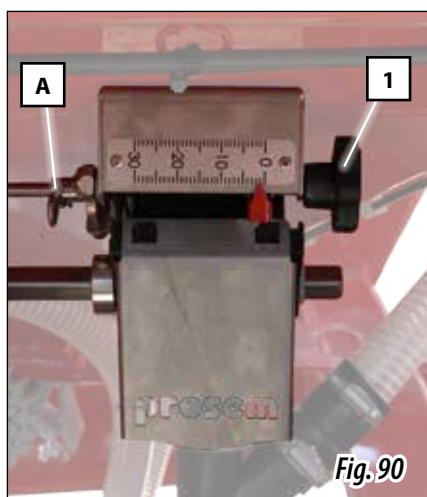

Fig. 90

PREVIOUS FLOW TEST	
SEED DRILL	WHEEL TURNS
600	36,5
700	31,3

		WORKING WIDTH			
		6 (metres)		7 (metres)	
		WORKING SPEED			
		8 - 10 Km/h	12 - 14 Km/h	8 - 10 Km/h	12 - 14 Km/h
OPENING OF THE METERING UNIT	5	25,3	23,5	21,6	20,2
	10	35,5	33,8	30,5	29
	15	46,5	44,9	40	38,5
	20	56	54,2	47,9	46,5
	25	58,6	58,6	50,3	50,3
	30	60	59,6	51,4	51,1
		(kg/ha)			

*Reference fertiliser: Agristar Complet (specific weight: 0,99 Kg/dm³).



IN CASE THE AMOUNT OF FERTILISER TO BE DISTRIBUTED IS **LOWER THAN THE VALUES SPECIFIED IN THE TABLE**, ONE METERING UNIT NEEDS TO BE DISCONNECTED. TO DISCONNECT IT, DO THE FOLLOWING: CLOSE THE METERING UNITS COMPLETELY, REMOVE THE PIN THAT CONNECTS THAT METERING UNIT TO THE TRANSMISSION AXLE (A, FIG. 90) AND NEXT THE DOSAGE CAN BE ADJUSTED (DIVIDE BY TWO THE VALUES OF THE PREVIOUS TABLE).

11- WARRANTY

MAQUINARIA AGRÍCOLA SOLÀ, S.L. ensures the smooth functioning of any product according sold to the technical specifications of the WARRANTY CERTIFICATE provided with each machine. Any delivery note accompanying the goods will eventually result in a VAT invoice. If the BUYER considers the goods to be in warranty and they should not be invoiced, the problem will be analyzed and, if appropriate, your account will be credited. In order for the warranty to be valid, the WARRANTY CERTIFICATE must be returned once it has been properly filled in by the DEALERSHIP and the BUYER.

MAQUINARIA AGRÍCOLA SOLÀ, S.L. will not be held responsible for any damage caused by misuse, or by not checking the smooth functioning of the goods when either starting the machine or during the sowing season (see section 3.4 USE ACCORDING TO DESIGN).

Neither the DEALERSHIP or the BUYER or the USER will be able to claim compensation to MAQUINARIA AGRÍCOLA SOLÀ, S.L. for incidental damages such as labour costs, transport, faulty work, damages to persons or goods, harvest loss or reduced harvest, etc.

Material exchanges or returns will be paid by the buyer with the previous consent of MAQUINARIA AGRÍCOLA SOLÀ, S.L. OPTIONAL EQUIPMENT and SPARE PARTS which have surpassed three months since delivery or have been manufactured ex professo, will only be accepted as an exception. Parts eligible for warranty coverage need to be returned to the factory to be checked and eventually exchanged, They need to be returned accompanied with a note explaining the problem and containing the machine model and serial number. Warranty coverage remains subject to the decision of MAQUINARIA AGRÍCOLA SOLÀ, S.L. Any repair which has not been approved by MAQUINARIA AGRÍCOLA SOLÀ, S.L. will not be covered under WARRANTY.

DATE	NOTES

