

A-6000/NS PLUS

MANUAL COMMISSIONING, MAINTENANCE AND DOSAGE

Carefully read this Manual before using the machine



SOLÁ seed drillers and fertilizer spreaders are manufactured in a highly specialized environment and our factory has a vast customer-endorsed experience.

SOLÁ machines use highly advanced technology and are guaranteed to work without malfunctions in a great variety of conditions. They are provided with easy-to-use and efficient devices.

SOLÁ machines perform excellently with only minimum operator maintenance.

*This manual will help you use your **SOLÁ** product with the upmost efficiency.*



Certified quality system

1st Edition – September 2015

Ref.: CN-811075/GB

Created by: SOLA

It is forbidden to copy any part of this manual.

Specifications are subject to change or modification without notice.

The pictures included do not necessary show the standard version.

TABLE OF CONTENTS

1. INTRODUCTION	5
2. SAFETY INSTRUCTIONS	6
2.1 SAFETY SIGNS.....	6
2.2 GENERAL SAFETY INSTRUCTIONS	7
2.3 LOADING AND UNLOADING INSTRUCTIONS.....	7
3. GENERAL DESCRIPTION	8
3.1 OVERVIEW OF THE MACHINE	8
3.2 TECHNICAL SPECIFICATIONS	9
3.3 IDENTIFICATION OF THE MACHINE	9
3.4 USAGE ACCORDING TO DESIGN	9
3.5 STANDARD EQUIPMENT.....	10
3.6 OPTIONAL EQUIPMENT.....	10
4. FUNDAMENTAL CONCEPTS FOR PLANTING	10
4.1 TERRAIN.....	10
4.2 SEED	10
4.3 DEPTH	10
5. COMMISSIONING	12
5.1 COUPLING THE SEED DRILLER TO THE TRACTOR.....	12
5.2 COUPLING AND ADAPTING THE CARDAN TRANSMISSION	13
5.3 HYDRAULIC SYSTEM.....	13
5.4 TRANSPORTATION POSITION.....	14
5.5 LOADING AND UNLOADING THE HOPPER	15
5.6 SUPPORT FEET.....	16
5.6.1 FRONT SUPPORT FOOT.....	16
5.6.2 REAR SUPPORT FOOT	16
5.7 PARKING BRAKE.....	17
5.8 END OF MACHINE WORK	17
6. ADJUSTMENTS	17
6.1 MACHINE LEVELLING	17
6.1.1 TOW-BAR AND TRACTOR LEVELLING.....	17
6.1.2 SOWING EQUIPMENT LEVELLING.....	18
6.2 DEPTH CONTROLS.....	18
6.2.1 DEPTH TINES	18
6.2.2 DEPTH CONTROL WHEELS	18
6.2.2 COULTERS	19
6.3 DOSAGE.....	19
6.3.1 NORMAL SEEDS (N position)	20
6.3.2 SMALL SEEDS (F position).....	20
6.4 SEED DOSAGE ADJUSTMENT	21
6.5 SEED FLOW PRE-TESTING	21
6.6 SEED DOSE FIELD TESTING.....	22
6.7 HARROW.....	23
6.8 TRACK ERASERS.....	23
6.9 LEVELLER.....	23
6.10 HYDRAULIC TRACK MARKERS.....	23
6.10.1 TRACK MARKER LENGTH ADJUSTMENT.....	24
6.10.2 TRACK MARKER DISC INCLINATION ADJUSTMENT	24
6.11 INCLINATION OF FOLDING PARTS.....	24
7. DISTRIBUTION TYPE	25
7.1 WITH MECHANICAL DRIVE TURBINE	25
7.2 WITH HYDRAULIC DRIVE TURBINE.....	25
8. SOWING ELECTRONIC CONTROL	26
8.1 CONTROL PANEL, DESCRIPTION.....	26
8.2 RUNNING SPEED - C1	26
8.3 TOTAL AREA / SEED DRILLER WIDTH - C2	27
8.4 CONTROL PANEL WITH TRACK MARKER (OPTIONAL)	27
8.5 ROAD TRACKING - C3.....	28
8.6 TURBINE ROTATIONAL SPEED/TURBINE ALARM - C4.....	31
8.7 DISTRIBUTOR SHAFT - C5.....	31
8.8 HOPPER LEVEL ALARM - C6.....	31
8.9 TOTAL SEEDING CUT OFF (OPTIONAL).....	32
8.10 EXIT CLOSING AT FOLDING PARTS (OPTIONAL)	32

9. MAINTENANCE 33

9.1 SERVICE FREQUENCY 33

9.2 SEED DRILLER CLEANING 34

9.3 SCREW JOINTS 34

9.4 LUBRICATION AND GREASING 34

9.5 TYRE PRESSURE 35

10. DOSAGE CHART 35

10.1 SEED CHART 35

10.2 MICRO-GRANULATED FERTILIZER CHART (OPTIONAL) 37

10.3 NORMAL FERTILIZER CHART (OPTIONAL) 37

11. GUARANTEE 38

12. SPARE PARTS 39

12.1 CHASSIS 40

12.2 TENSIONER 41

12.3 FIXED SOWING COULTER 42

12.4 ADJUSTABLE SOWING COULTER 43

12.5 TRACK ERASER COULTER 44

12.6 SIDE WHEEL FOR DEPTH CONTROL 45

12.7 TRACK MARKER 46

12.8 TURBINE WITH BUSH 47

12.9 SEED FALL HOSE ASSEMBLY 48

12.10 SEED DISPENSER 49

12.11 HARROW 50

12.12 COMPACTING ROLLER 51

12.13 SET OF LATERAL STOPS 52

12.14 EQUIPMENT-HOLDER CHASSIS 53

12.15 PNEUMATIC DISTRIBUTION 54

12.16 FINISHES 55

13. NOTES 57

1- INTRODUCTION

It is essential to READ AND FOLLOW THE INSTRUCTIONS AND RECOMMENDATIONS in this manual before operating the **SEED DRILLER A-6000/NS PLUS**. Careful reading enables maximum operator efficiency, prevents accidents and damage, and increases the seed driller's capacity and life expectancy.

Please ensure that this manual has been read by any person involved in performing operational tasks, (including preparation, dealing with mechanical problems and supervising the machine), maintenance (inspection and technical assistance) and transport.

For your safety, please follow these technical safety instructions as **SOLÀ** will not be responsible for damages caused by not observing the information provided.

In the first chapters you will find the Technical Characteristics and Safety Instructions, as well as some essential sowing concepts. Basic concepts that are required to operate the machine are explained in the Starting and Maintenance sections.

The last part of this manual consists of Dosage Tables, detailed by seed type.



SOLÀ RETAINS THE RIGHT TO MODIFY ILLUSTRATIONS, TECHNICAL DATA AND WEIGHTS INDICATED IN THIS OPERATING MANUAL, IF THESE CHANGES HELP TO IMPROVE THE QUALITY OF THE SEED DRILLERS.

2. SAFETY INSTRUCTIONS

2.1 SAFETY SYMBOLS

In this operating manual you will find three different symbols relating to safety:



To facilitate operation with the seed drill.



To avoid damages on the seed drill or in the optional equipments.



This symbol warns of the risk of injury.

On the machine, you will find the following symbols:



Read the instructions carefully and observe the safety advice given in the operating manual.



During the coupling manoeuvre, stay away from the rear part of the tractor. Risk of serious physical injury.



During maintaining or repairing the seed drill, you must stop the tractor's engine completely, it must not be started.



Never stand under the sowing equipment, or within its operation area. Risk of serious physical injury.



Risk of being crushed when working under the machine, please secure the machine to prevent this risk.



Never use the ladder to access the platform when the machine is running. It is forbidden to ride on the machine during operation. Risk of serious physical injuries.



Danger of infection from escaping hydraulic fluid at high pressure! This can inflict serious injuries with potentially fatal consequences if it passes through the skin and into the body. Keep the hose lines in good condition. Risk of serious physical injuries.



Never stand under track markers or in their operational area. Risk of serious physical injuries.



Do not insert your hand into the hopper while the drive wheels are turning. Risk of serious injury.



Respect the maximum load.



Coupling point for transport by crane.

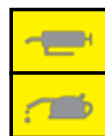

Keep the machine parts showing these lubrication and greasing symbols in good conditions and greased. See section 9.4 LUBRICATION AND GREASING POINTS



PTO shaft's speed and turning direction (only in machines with mechanical fans).

2.2 GENERAL SAFETY INSTRUCTIONS



- Before starting the machine, please check the machine is in good condition for work and is safe for road use.



- Check that visibility is clear around the machine and there is no person in the working area.



- In thoroughfare, please observe traffic signs and regulations.



- It is forbidden to ride on the machine or climb into the machine when it is running.



- Before using the machine, the user must be familiar with all operating elements.



- Please be extremely careful when coupling and uncoupling the machine to the tractor.



- Please check that the PTO shaft is in good condition and well protected. Prevent the protective tube from turning by holding both the tube and chain provided for this purpose.



- Mount the PTO shaft's transmission only when the tractor's engine is off.



- Before connecting the PTO shaft, be sure that the danger zone surrounding the machine is clear.



- Never leave the tractor's driver's seat while the machine is in operation.



- Do not deposit external elements inside the hopper.



- When maintaining the hydraulic system of the seed driller, make sure that it is depressurised and the tractor's engine is off.



- Please regularly check the condition of the tubes and hosepipes in the hydraulic system. These parts age naturally and their life should not surpass 6 YEARS. Please replace when necessary.



- When transiting with the sowing equipment raised, block the lowering switch. Before leaving the tractor, lower the support feet, lower the sowing equipment onto the ground and remove the tractor's starting key.



- Always use enough supporting elements when maintaining the machine in a raised position to prevent the machine from lowering or falling.



- Before planting, evaluate the potential risks in the area such as very steep slopes, possible contact with overhead power lines due to uneven floors and/or configuration of moving parts of the machine.

2.3 LOADING AND UNLOADING INSTRUCTIONS



- THESE OPERATIONS SHOULD BE PERFORMED ONLY BY QUALIFIED AND EXPERIENCED PERSONNEL.



- WHEN THE PLANTER IS DELIVERED, IT SHOULD BE IMMEDIATELY CHECKED TO DETECT POSSIBLE DAMAGES DURING TRANSPORTATION OR MISSING PIECES. ONLY THE IMMEDIATE REPORTING OF THIS TO THE DELIVERER WILL RESULT IN COMPENSATION.



- LOADING AND UNLOADING THE MACHINE MUST BE PERFORMED, IF POSSIBLE, USING A BRIDGE CRANE.

GENERAL DESCRIPTION



WARNING: SEE SECTION 3.2, TECHNICAL CHARACTERISTICS, FOR KNOWING THE LOAD THAT THE BRIDGE CRANE SHALL SUPPORT

The images show the towrope arrangements and mooring points for this operation:

- **Parte delantera:** Una sirga en el enganche ubicado en la parte interna delantera de la tolva (Fig. 2).

- **Parte trasera:** dos sirgas dispuestas en el subchasis del equipo de siembra (Fig. 3).

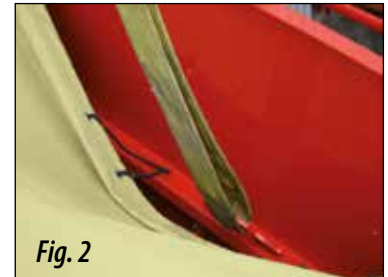

3. GENERAL DESCRIPTION

3.1 OVERVIEW OF THE MACHINE

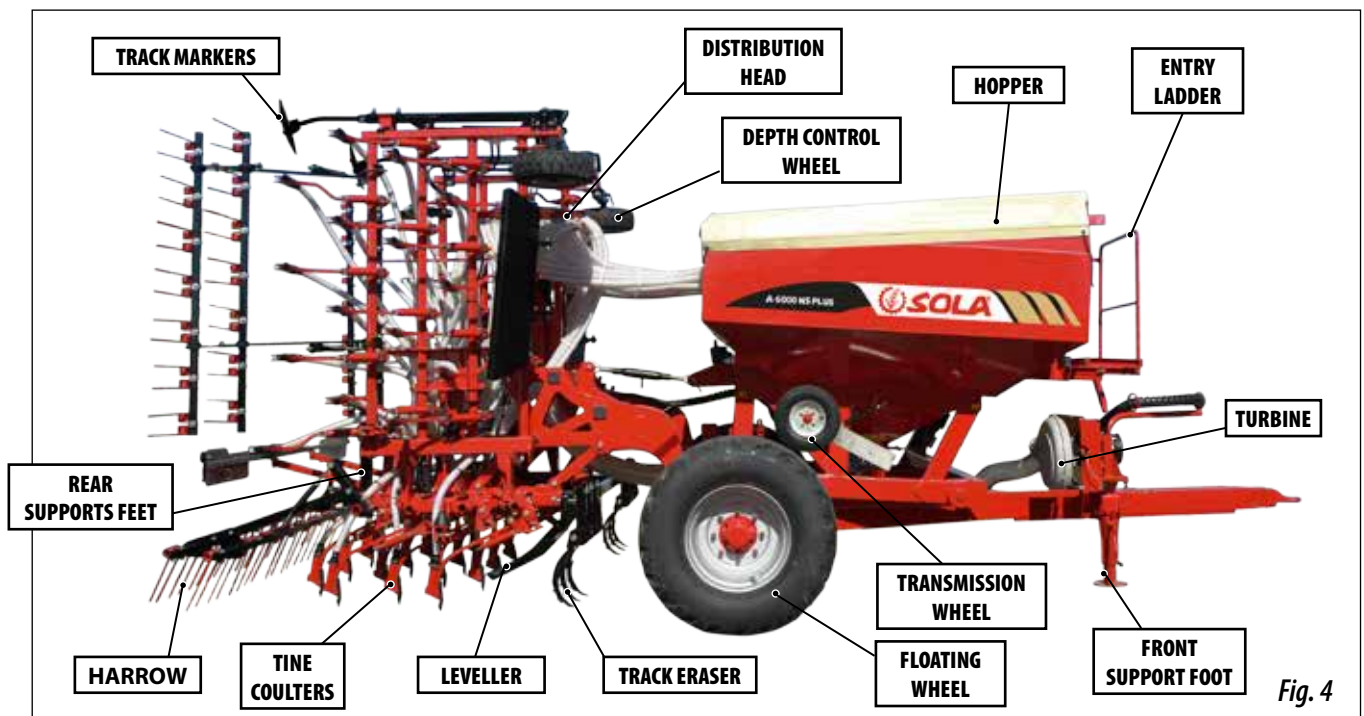

3.2 TECHNICAL SPECIFICATIONS

MACHINE TYPE AND # OF COULTERS	DISTANCE BETWEEN COULTERS (cm)	HOPPER CAPACITY (litres)	ESTIMATED WEIGHT (kg)	WHEELS
600/37	16	5500	4600	560/45R22.5
700/43	16	5500	5000	560/45R22.5

MACHINE TYPE AND # OF COULTERS	WORK WIDTH (m)	TRANSPORT WIDTH (m)	MAXIMUM HEIGHT (m)	LENGTH (m)
600/37	6	3	3,1	7
700/43	7	3	3,6	7

3.3 IDENTIFICATION OF THE MACHINE

All the machines have an IDENTIFICATION PLATE on the linkage, specifying:

- 1- Name and address of the manufacturer.
- 2- SOLÀ brand
- 3- Machine model
- 4- Machine type
- 5- Serial number
- 6- Approval number
- 7- Maximum authorized mass (kg.)
- 8- CE Certificate.

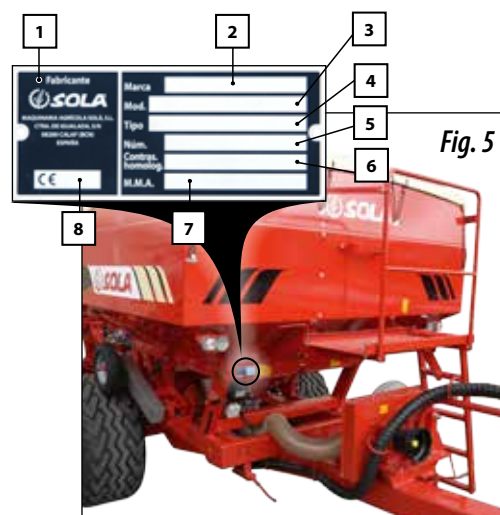

Fig. 5

3.4 USAGE ACCORDING TO DESIGN

The **A-6000/NS PLUS** seed driller has been designed for sowing of cereals and other kind of grain seeds.

The machine has been designed for being dragged by an agricultural tractor.

If the machine is damaged due to other uses than the above, the manufacturer will not be held responsible (see section 11. GUARANTEE).

All legal provisions relating to machine safety, traffic, and health and safety at work shall be respected.

The changes made by the user override the manufacturer's guarantee for any damage or injury (see section 11. GUARANTEE).

Avoid using wet seeds; their use may cause clogging.

3.5 STANDARD EQUIPMENT

- 5.500-litre hopper for seeds (for machine versions A-6000/NS PLUS)
- Combined hopper: seeds (3500 litres) and fertilizer/micro-granulated (2000 litres) (for machine versions A-6000/NS PLUS - COMBI).
- Selector sieve.
- Kit for seed dosage calibration: scale, crank and grain counter.
- Hopper entry ladder.
- Adjustable sowing depth by means of tines.
- Sowing depth control lateral wheels.
- Height-adjustable front support foot.
- Sowing equipment support feet.
- Canvas cover for hopper.
- Signalling, positioning, braking and flashing lighting equipment.
- Hydraulic service brake.
- Parking brake.
- Monitor with turbine tachometer, distributor rotation alarm, hopper seed level sensor and hectare counter.
- Mechanical total seeding cut off.
- Authorization for running.
- Rear harrow in three independent sections.
- 4-line coulter sowing equipment.
- Hydraulic or mechanical drive turbine.
- Track erasers for tractor tracks.
- Leveller in three independent sections.
- Hydraulic track markers.

3.6 OPTIONAL EQUIPMENT

- Exit closing at foldable parts.
- Road tracking (tramlines).
- Hydraulic drive kit with PTO pump with cooling system.
- Seed distributor transmission with electric engine and monitor for variable dose or total seeding cut off.
- Kit with 2 solenoid valves for tractor distributor.
- Artemis radar.

4. FUNDAMENTAL CONCEPTS FOR PLANTING

4.1 TERRAIN

The better terrain conditions, the better the sowing quality. A good labour cannot be carried out in big clods or very uneven furrows. Although SOLA machines resist harsh conditions, if the seedbed does not satisfy the appropriate conditions, then the sowing quality will be poor.

4.2 SEED

It is essential to use clean, quality seeds and, in the case of barley, the seed must be deburred.

4.3 DEPTH

Seed planting depth affects tillering, the plant's strength, and its ability to resist frostbite or drought: the tillering node is always 1 or 2 cm under the surface, regardless of the seed planting depth.

Planting deeper does not mean getting deeper roots. Only a few roots grow from the lower part of the seed. Most of them grow from the tillering node closer to the ground level.

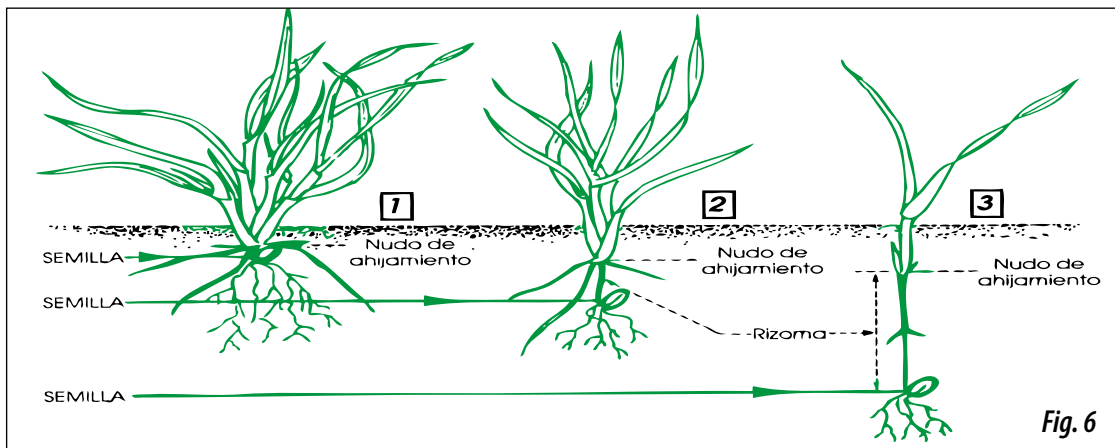

ADVISABLE DEPTH IS BETWEEN 3 AND 5 CENTIMETRES. SOWING TOO DEEPLY IS A SERIOUS ERROR, SINCE THE RHIZOME CANNOT REACH THE SURFACE AND THE PLANT DIES. NO MATTER IF SOME GRAINS ARE VISIBLE. THE HARROW COULTERS WILL EVENTUALLY COVER THEM.

**Sowing at normal depth:
from 2 to 4 cm**

Thick stem, short rhizome and good resistance to ice.

Multiple tillering of 3 to 6 tiles and many leaves, between 6 and 10.

Big rooting, 5 cm in width and 10-12 cm in depth.

More sprigs are obtained with fewer grains per sowing square meter.

**Deeper sowing:
between 5 and 6 cm**

Thin stem, ice-exposed rhizome.

Late and poor tillering, 1 or 0 tiles and few leaves, 3 or 4 approx.

Regular rooting, 3 cm in width and 5 cm in depth.

More grain per square meter is necessary to obtain the same sprigs as in the first case.

**Too deep sowing:
from 8 to 10 cm**

Very thin stem. Not tillering and one leaf.

Grain reserves exhaust in a large rhizome that the ice can easily cut.

Poor rooting, 1 cm in width and 3 cm in depth.

The double amount of grain per square meter is necessary to obtain the same sprigs as in the first case.



IN VERY COLD PLACES, REPEATED FROSTBITE CAN PRODUCE A BULKING EFFECT ON THE GROUND'S MOST SUPERFICIAL LAYER WITH THE RISK OF LOOSENING AT THE PLANT'S INCIPIENT ROOTS, CAUSING THE PLANT TO DIE. IN THESE CASES, IT WOULD BE ADVISABLE TO PLANT SLIGHTLY DEEPER AND, IF POSSIBLE, TO USE THE ROLLER FOR COMPACTING THE SOIL AND BETTER PROTECT THE SEEDS.



WHEN STARING THE MACHINE, THE FIRST METER OF FURROWS WILL NOT CONTAIN ANY SEED. ON THE CONTRARY, WHEN STOPPING THE MACHINE, THE SEEDS THAT WERE ALREADY FALLING THROUGH THE HOSES WILL SLIDE FROM THE MACHINE AND END UP PILED IN THE LAST METER. CONSIDER THIS IN ORDER TO ACHIEVE A GOOD RESULT.



ALWAYS WORK AT UNIFORM SPEED. SUDDEN ACCELERATING AND BRAKING WILL CAUSE AN IRREGULAR SEED DISTRIBUTION.

5. COMMISSIONING

The issues to take into account before starting the machine are detailed below:

- Verify that the mechanical components are well greased. Periodically grease the mechanical components (see section 9.4 LUBRICATION AND GREASING POINTS).
- Verify the tyre pressure (see section 9.5 TYRE PRESSURE).
- Verify that the hydraulic circuit conducts of the machine and the pneumatic conducts (seed transport) are in good conditions.

5.1 COUPLING THE SEED DRILLER TO THE TRACTOR

The **A-6000/NS PLUS** seed driller is fitted with a rotating shaft-ring hook.



MAKE SURE THAT NOBODY AND NOTHING IS BETWEEN THE TRACTOR AND THE SEED DRILLER WHEN COUPLING AND UNCOUPLING.



THESE PROCEDURES REQUIRE PAYING MAXIMUM ATTENTION TO AVOID DAMAGE TO THE OPERATOR.



MACHINE COUPLING AND UNCOUPLING PROCEDURES MUST BE CARRIED OUT WITH THE SUPPORT FEET AT THEIR LOWEST POSITION.

Follow the steps below for the coupling manoeuvre:

- 1- Plug in the hydraulic circuit connectors of the machine to the tractor distributor, for:
 - 1.1- FOLDABLE PARTS OF THE SOWING EQUIPMENT
 - 1.2- TRACK MARKERS
 - 1.3- SOWING EQUIPMENT AND TRACK ERASER
 - 1.4- HYDRAULIC TURBINE
 - 1.5- HYDRAULIC SERVICE BRAKE



THE NECESSARY HYDRAULIC CONNECTIONS FOR THESE ELEMENTS ARE SPECIFIED IN SECTION 5.3 HYDRAULIC SYSTEM.



FOR MACHINE VERSIONS WITH HYDRAULIC TURBINE, CARDAN TRANSMISSION MUST BE ADAPTED ONCE THE MACHINE IS COUPLED TO THE TRACTOR (SEE SECTION 5.2 COUPLING AND ADAPTING THE CARDAN TRANSMISSION).

After coupling the seed driller with the tractor:

- Verify that the machine is correctly attached to the tractor.
- Before starting the machine, get familiar with all its components and adjustments.
- Start the machine being empty in order to free the conducts from any condensation of water or possible dirt.
- Adjust the machine and all its components, the type of terrain and the seed.

- 2- Plug in the electrical connector for the lightning equipment.
- 3- Place the front support feet in vertical position (see section 5.6 SUPPORT FEET).
- 4- Lower the central sowing equipment until touching the ground.
- 5- Hook the seed drill rotatory ring to the tractor at the towing hook point. (Fig. 7).



IF THE HOOK POINT IS TOO LOW, SEE SECTION 6.1.1 TOW-BAR AND TRACTOR LEVELLING.

- 6- Lift the machine support foot.



BEFORE MOVING THE MACHINE, MAKE SURE IT IS CORRECTLY HOOKED TO THE TRACTOR.



FOR UNCOUPLING THE MACHINE AND THE TRACTOR, PERFORM THE STEPS IN THIS SECTION INVERSELY.

5.2 COUPLING AND ADAPTING THE CARDAN TRANSMISSION

Once the seed driller is coupled to the tractor, the TRANSMISSION MUST BE ADAPTED for the equipment with mechanical turbine. In order to do so, it is necessary to:

- 1- Dismantle and introduce one end in the PTO and the other end in the seed driller. Therefore, introduce the cardan into the threaded shaft in both machines, maintaining the security plug pressed, release the plug and move the cardan back until hearing a click sound; this sound means that the plug is in its corresponding receptacle.



ASSEMBLY HOMOKINETIC TRANSMISSION CARDAN INTO THE TRACTOR PTO.



ALWAYS HANDLE THE TRANSMISSION WITH THE ENGINE OFF. ALWAYS WORK WITH THE TRANSMISSION PROTECTED AND IN GOOD CONDITIONS. AVOID ANY ROTATION IN THE TRANSMISSION PROTECTION TUBE BY FIXING IT WITH THE CHAIN.

- 2- Determine the minimum shift length "L" (Fig. 8), By lifting and lowering the hydraulic lift.

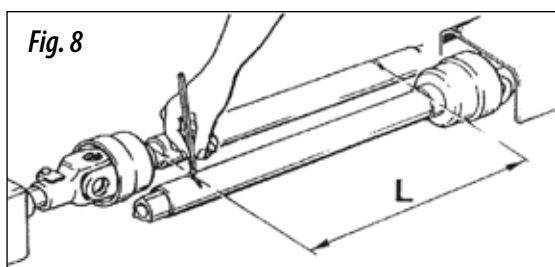

- 3- Cut the plastic and metal surplus parts with the same size and reassembly the transmission (Fig. 9).

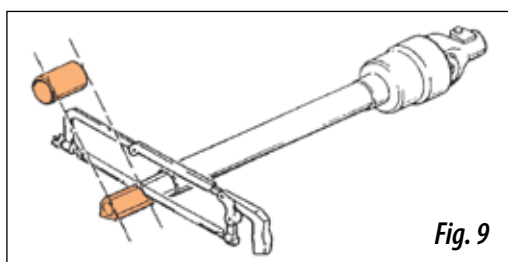

- 4- Activate the seed driller lift and verify that the transmission shift is correct.
- 5- Secure the cardan to the tractor by means of the fixing chain (Fig. 10).

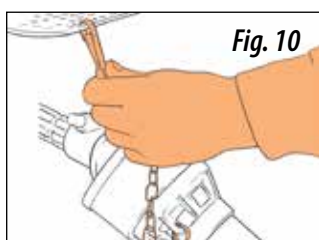

PREVENT THE TRANSMISSION FROM WORKING IN A VERY STEEP INCLINATION ANGLE (MAX. 35°)



COUPLE THE TRACTOR PTO SMOOTHLY SUD-DEN ACCELERATION CAN RESULT IN SERIOUS DAMAGE TO THE SEED DRILLER.

5.3 HYDRAULIC SYSTEM

The machine requires hydraulic connexion for:

- FOLDING AND UNFOLDING THE FOLDABLE PARTS OF THE SOWING EQUIPMENT. One double discharge
- FOLDING AND UNFOLDING THE TRACK MARKERS: One double discharge
- LOWERING AND LIFTING THE SOWING EQUIPMENT AND TRACK ERASER (optional). One double discharge with key for removing the track eraser.
- HYDRAULIC TURBINE One double discharge
- HYDRAULIC SERVICE BRAKE One simple discharge

Hydraulic circuits can be distinguished by their colours according the following chart:

TAP COLOUR	DESCRIPTION
BLUE	Hydraulic system for trackers
GREEN	Hydraulic system for folding the sowing equipment.
RED	Hydraulic system for service brake and turbine (only for versions with hydraulic turbine)
YELLOW	Hydraulic system for lifting the sowing equipment and track erasers.

Two flow regulators (Fig. 11) help the hydraulic folding and unfolding processes to be carried out smoothly: Each hydraulic system has one regulator for each operation, which must be adjusted according to the hydraulic flow supplied by the tractor. It is advisable to star the operation with the regulator almost closed for preventing fast unfolding that may cause damage to the seed driller.

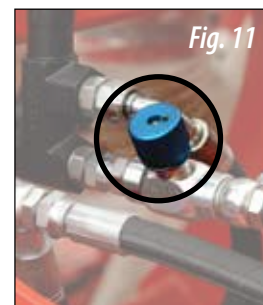

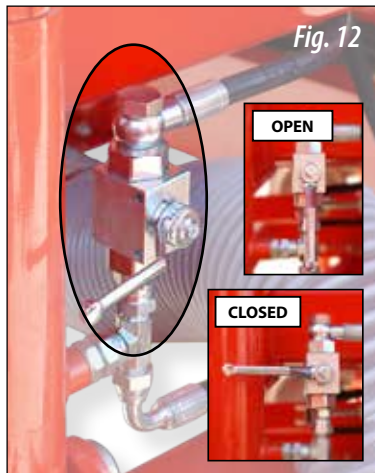

For machine versions with track eraser, this element can be excluded with the stopcock (Fig. 12) placed between the hopper and the seed drill. See the stopcock positions in the images, being: **OPEN**: for including the track eraser, and **CLOSED**: for excluding the track eraser.

The machine also includes security locks (1, Fig. 13) that must be used for securing the lateral equipment while the machine is transported. The image shows the trigger in locked position.

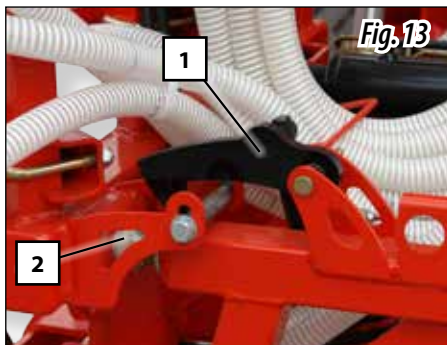

IF THE FOLDABLE PARTS DO NOT DESCEND WHEN PRESSURING THEIR HYDRAULIC CIRCUIT, MAKE SURE THAT THE SECURITY LOCKS ARE UNLOCKED (1, FIG. 13). OTHERWISE, FOLD THE EQUIPMENT AGAIN AND ADJUST THE FOLDING STOPS (2, FIG. 13).



WHEN OPENING OR CLOSING THE FOLDING PARTS AND THE TRACK MARKERS, MAKE SURE THAT NOBODY AND NOTHING IS NEAR THE MACHINE OR ALONG THE TRAJECTORY OF THE MOVABLE PARTS.



ALWAYS PERFORM MACHINE MAINTENANCE WORKS WITH THE HYDRAULIC CONNECTIONS UNPLUGGED.



KEEP THE HYDRAULIC HOSE LINES IN GOOD CONDITION. THE PRESSURE OIL CAN PENETRATE THE SKIN CAUSING SERIOUS INJURIES.



USE ONLY THE HYDRAULIC HOSE LINES PROVIDED BY THE MANUFACTURER.

5.4 TRANSPORTATION POSITION

With the machine coupled with the tractor and the hydraulic circuits connected to the tractor distributor, follow the steps below for transporting the machine:



- 1- Fold the track markers.
- 2- Lift the lateral equipment and make sure that the security locks are locked (Fig. 15).



- 3- If the track eraser is down, make sure that its stopcock is open.
- 4- Lift the seed drill and track eraser up to their maximum position.



AFTER FOLDING THE MACHINE, AND BEFORE TRANSPORTING IT, MAKE SURE THAT THE TRACK ERASER HAS BEEN LIFTED; OTHERWISE, VERIFY THAT THE STOPCOCK IS OPENED AND REPEAT THE PREVIOUS STEPS IN THIS SECTION.



AVOID THE MOVEMENT OF THE MOVABLE ELEMENTS.

5.5 LOADING AND UNLOADING THE HOPPER

For a safe and fast hopper load, the best option is using a screw conveyor. An hydraulic crane can also be used for lifting the BIG BAG and put it on top of the hopper for coupling it; follow the manufacturer instructions.



IMPORTANT: BEFORE EMPTYING THE HOPPER, MAKE SURE THAT NOTHING REMAINS INSIDE THE HOPPER.



BEFORE FILLING THE HOPPER, MAKE SURE THAT THE EMPTYING TRAP DOORS ARE CLOSED.

For **FILLING** the hopper:

- 1- Pull the lock (1, Fig 16) for releasing the hopper landing, then move the ladder until it reaches the horizontal position.

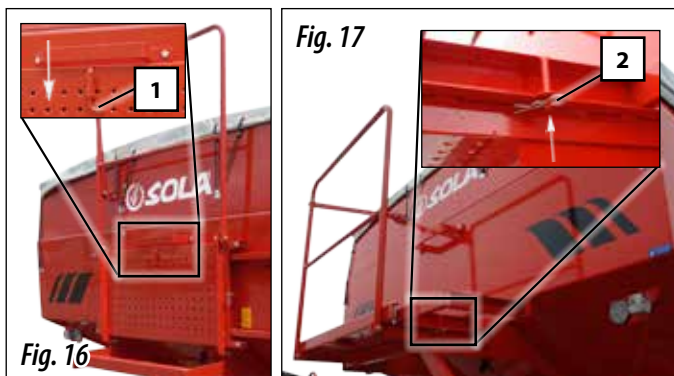

- 2- Remove the locking pin (2, Fig 17) and slightly pull the ladder upwards for releasing the locking point (indication, Fig. 17).
- 3- Pull the ladder horizontally up to the end of its trajectory. Then, move it until it reaches the vertical position and the stop end (Fig. 18).



- 4- Remove the fastening rubber bands of the canvas (Fig. 19).

- 5- Take the handle at the ladder side (Fig. 20) and place it at the end of the canvas (Fig. 21). Turn the handle for removing the canvas (Fig. 22).

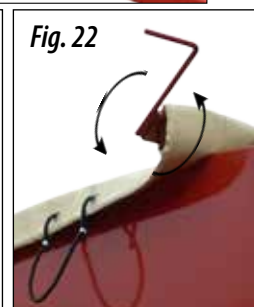
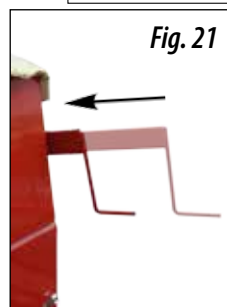
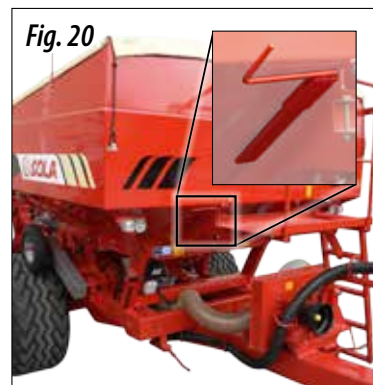

IF THE CANVAS CANNOT BE REMOVED, MAKE SURE THAT ALL FASTENING RUBBER BANDS HAVE BEEN REMOVED.

- 6- Fill the hopper with the seeds.
- 7- Once the hopper is full, close the canvas cover, keep the handle, fold the access ladder and lock the locking pin.



FOLD THE STAIRS AFTER LOADING OR INSPECTING THE HOPPER.

For **EMPTYING** the hopper:

- 1- Place a container or sack in front of the dispenser emptying trap door (Fig. 23).
- 2- Turn the handle to the left for opening the trap door and emptying the hopper (1, Fig. 23).
- 3- When finishing this task, close the trap door by turning the handle to the right (1, Fig. 23)

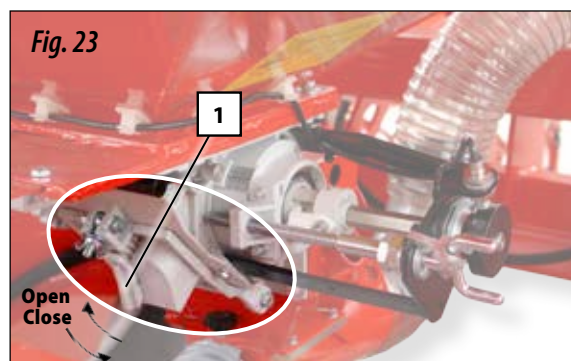

COMMISSIONING

For fast **HOPPER EMPTYING**:

- 1- Loosen the wing nut (2, Fig. 24).



- 2- Slightly push on the trap door and move the screw and the wing nut upwards (indication, Fig. 24).
- 3- Once the seeds stop falling, close the trap door placing the screw and tightening the wing nut (Fig. 25).



IF SEEDS DO NOT FALL, MAKE SURE THAT THE SEED DISPENSED TAP IS OPENED (FIG. 25).

5.6 SUPPORT FEET

The machine is fitted with a hopper support foot (see section 5.6.1 FRONT SUPPORT FEET) and two feet for the sowing equipment (see section 5.6.2 REAR SUPPORT FEET).



LIFT THE SUPPORT FEET BEFORE OPERATING THE MACHINE. IF THE SUPPORT FEET ARE DOWN DURING OPERATION, THE EQUIPMENT MAY BE DAMAGED.



HANDLE THE SUPPORT FEET WITH THE MACHINE COUPLED TO THE TRACTOR.

5.6.1 FRONT SUPPORT FOOT

The front support foot is located at the hopper tow-bar. For **LOWERING** the support foot:

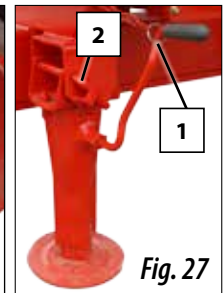
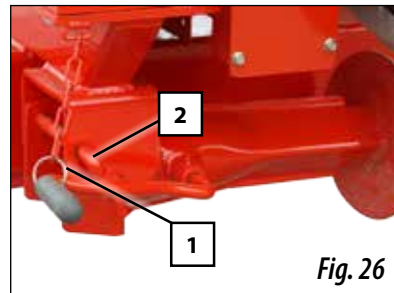

- 1- Remove the crank fastening chain (1, Fig. 26)
- 2- Hold the support foot with one hand and remove the security pin with the other hand (2, Fig. 26).
- 3- Place the support foot in vertical position and place the security pin (2, Fig. 27) for fixing its position.
- 4- Adjust the foot height with the crank (1, Fig. 27) and fasten the crank with the chain (Fig. 27).

For **LIFTING** the support foot:

- 1- Remove the crank fastening chain (1, Fig. 27) and the security pin (2, Fig. 27).
- 2- Lift the support foot up to reaching the horizontal position (Fig. 26) and place the security pin (2, Fig. 26).
- 3- Place the crank fastening chain (1, Fig. 26)

5.6.2 REAR SUPPORT FOOT

The rear support feet are located in the sowing equipment. For **LIFTING** or **LOWERING** the support foot:

- 1- Remove the security pin (A, Fig. 28) and the bolt (B, Fig. 28) for releasing the foot.
- 2- Move the support foot until reaching the desired position.
- 3- Place the security pin (A, Fig. 28) and the bolt (B, Fig. 28) for fixing the foot.

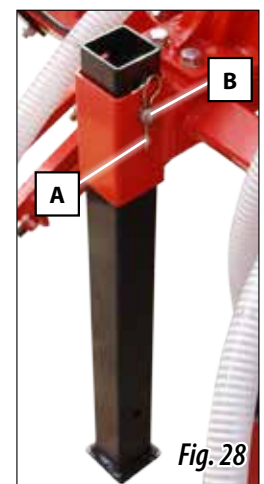

5.7 PARKING BRAKE

Turn the lever to the right for activating the parking brake and, turn it to the left for releasing.

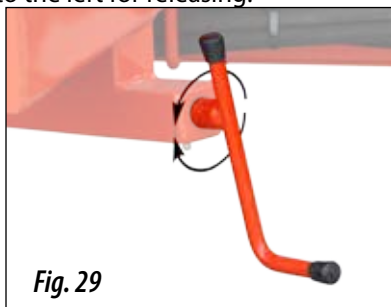

BEFORE SOWING, MAKE SURE THAT THE PARKING BRAKE IS RELEASED (WITHOUT BLOCKING THE FLOATING WHEELS)

6. ADJUSTMENTS

This chapter contains the necessary modifications necessary to adjust the A-6000/NS PLUS according to the terrain and seed. The values herein provided may vary according to the terrain conditions, climate factors and the machine conditions.

6.1 MACHINE LEVELLING



BEFORE USING THE MACHINE, MAKE SURE THAT IT IS CORRECTLY LEVELLED, BY THE SOWING EQUIPMENT AND BY THE TOW-BAR.

6.1.1 TOW-BAR AND TRACTOR LEVELLING



FOR COUPLING THE SEED DRILLER TO THE TRACTOR, PLACE THE TOWING HOOK POINT AT THE LOWEST POSSIBLE POSITION; THEREFORE, PLACE THE BOLT AND THE SECURITY PIN ABOVE THE PISTON ROD (B1).

By modifying the **TRAJECTORY LIMITING STOPS** at the hopper (1), the towing hook point in the seed driller to the tractor will go up or down. In order to do so, it is necessary to:

5.8 END OF MACHINE WORK

- Fully empty the hopper of any seed and fertilizer:
- Wash the machine with water, particularly the containers used for chemical products (see section 9.2 SEED DRILLER CLEANING).
- Verify that the machine components are in good condition. Substitute the worn components.
- Remove any particle that may produce corrosion. If necessary, paint these areas with anticorrosive paint or varnish.
- Grease and lubricate the indicated parts, chains and transmission gears (see section 9.4 LUBRICATION AND GREASING POINTS).

- 1- Plug in the hydraulic circuit connectors of the machine to the tractor distributor

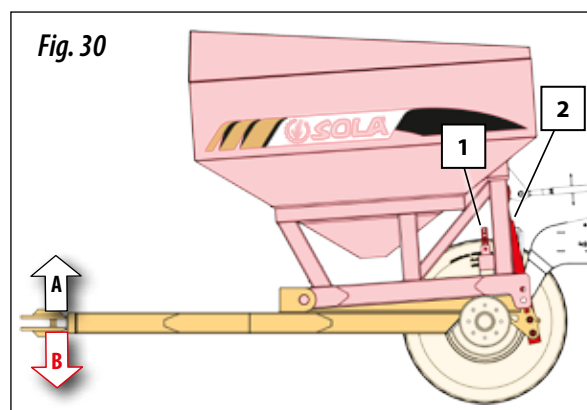

- 2- Apply pressure to the hopper hydraulic circuit (2) for unlocking the trajectory limiting stops (1)
- 3- Hold the stops, take the security pins and bolts out (3, Fig 31).

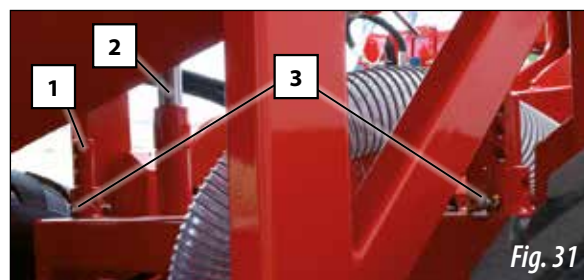

- 4- Move the stops (1) until reaching the desired position, the place the bolts and pins (3, Fig 31) for fixing the maximum trajectory.

ADJUSTMENTS

6.1.2 SOWING EQUIPMENT LEVELLING

Level the sowing equipment by modifying the tensor (4, Fig. 32) placed in the rear part of the seed hopper.

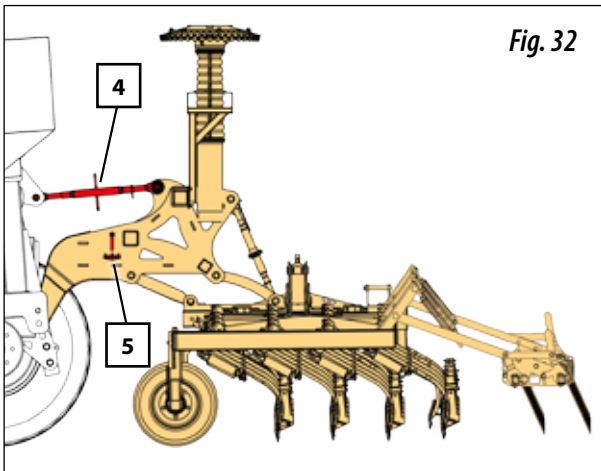

IN THE LATERAL PART OF THE CHASSIS, THERE IS AN INDICATOR WITH LEVEL MARKS (5, FIG. 32)



VERY IMPORTANT: PERFORM THE ADJUSTMENT WITH THE MACHINE COUPLED TO THE TRACTOR.



FOR FAST SOWING DEPTH ADJUSTMENT, ADJUST THE TINES (A, FIG. 33) IN **POSITION (0)**, THEN, THE TOW-BAR STOPS MUST BE ADJUSTED (FIG. 33. BIS).

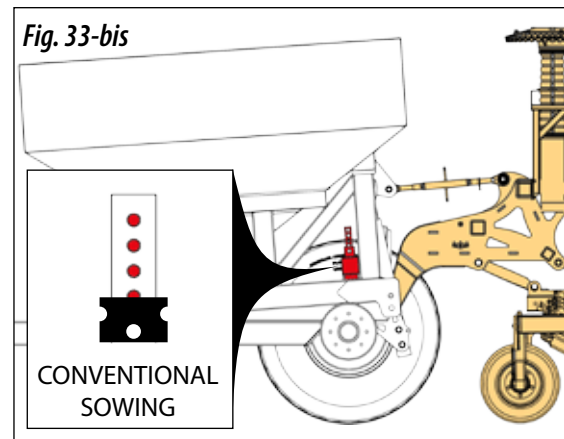
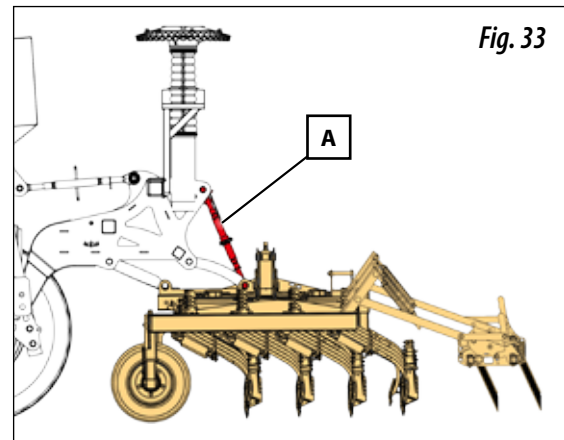

6.2 DEPTH CONTROLS

The sowing depth is controlled by means of:

- **DEPTH TINES** see section 6.2.1.
- **DEPTH CONTROL WHEEL** see section 6.2.2.
- **COULTERS** see section 6.2.3.

6.2.1 DEPTH TINES

The main tines determine the sowing depth (A, Fig. 33); both must be adjusted at the same depth. The tines are located in the rear part of the machine. They are adjusted by means of a pawl.

Once the tines are adjusted, the pawls must be kept so that they do not interfere with the folding and unfolding process of the foldable machine parts.

6.2.2 DEPTH CONTROL WHEELS

The lateral wheels of the sowing equipment ((1, Fig. 34) control the sowing depth at the foldable parts. For regulating these wheels, use the wrench (2, Fig. 35) provided with the machine. The adjustment steps are:

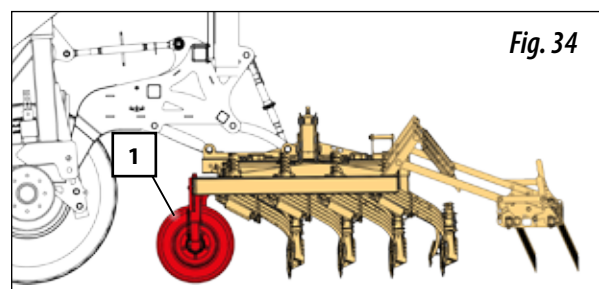



- 1- Unlock the wheel by means of the fastening handle.
- 2- Place the wrench (2, Fig. 35) and turn it to the left and to the right for lowering and lifting the sowing equipment.
- 3- Verify the desired work height with the graduated scale (3, Fig. 35).
- 4- Remove the wrench and clock the wheel with the fastening handle.



WHEN SOWING ON LOOSE AND SOFT SOIL, PLACE ONE OR TWO LATERAL WHEELS LESS IN ORDER TO COMPENSATE THE WHEEL SINKING ON THE TERRAIN. ADJUST THE WHEELS TO THE POSITION 2 OF THE SCALE.



FOR REGULAR SOWING, ADJUST BOTH WHEELS AT THE SAME HEIGHT.

6.2.3 COULTERS

The seed driller has two types of coulters.

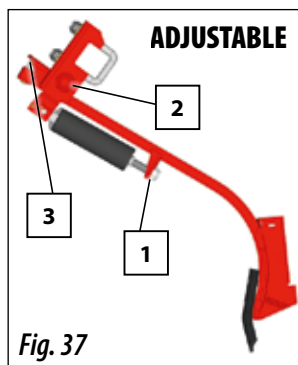
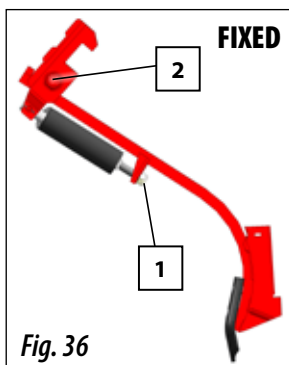

SEMI-FIXED COULTERS

These coulters are not adjustable in height; therefore, the sowing depth will be determined by the main sub-chassis adjustment tines (see section 6.2.1 DEPTH TINES).

These coulters allow modifying the pressure only by handling the nut placed in the lower part of the spring (1, Fig. 36).

A special SOLÀ labelled screw (2, Fig. 36) with self-locking nut fastens the coulter to the support. The lateral coulter looseness is controlled by handling this nut.

SOWING COULTERS WITH ADJUSTABLE HEIGHT

These coulters match with the tractor and seed driller wheels.



IMPORTANT: IF RUTS ARE VERY MARKED, IT IS ADVISABLE TO ADJUST THESE COULTERS.

In order to adjust the pressure applied by the coulter on the terrain, adjust the nut on the spring (1, Fig. 37). These coulters are attached to the support by means of a SOLÀ labelled screw (2, Fig. 37) with self-locking nut that controls the coulter looseness. These coulters are adjustable in depth, being possible to lower the coulters for adjusting their height turn the nut.

6.3 DOSAGE

The seed dispenser (Fig. 38) allows two dosage modes:

- **NORMAL** size seeds (N position).
- **SMALL/FINE** seeds, with minimum flows (F position).

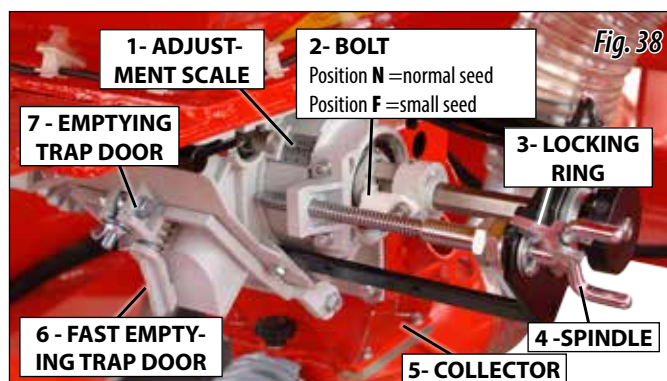

FOR CHANGING THE BOLT POSITION (2, FIG. 38) FROM NORMAL TO SMALL SEED, IT IS NECESSARY THAT THE SPINDLE (4, FIG. 38) CAN TURN AND THAT THE HOPPER IS EMPTY.



IMPORTANT: POSITION THE TURBINE AIR REGULATOR (FIG. 39) ACCORDING TO THE SEED TO BE USED (NORMAL - N POSITION; SMALL - POSITION)

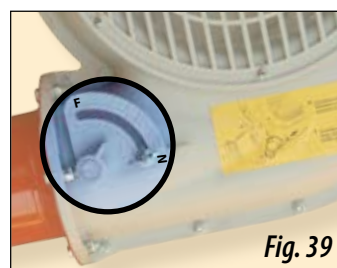

ADJUSTMENTS

6.3.1 NORMAL SEEDS (N position)

Follow the following steps for sowing with **NORMAL SEEDS**:

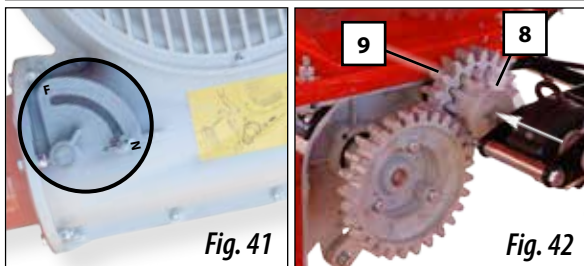
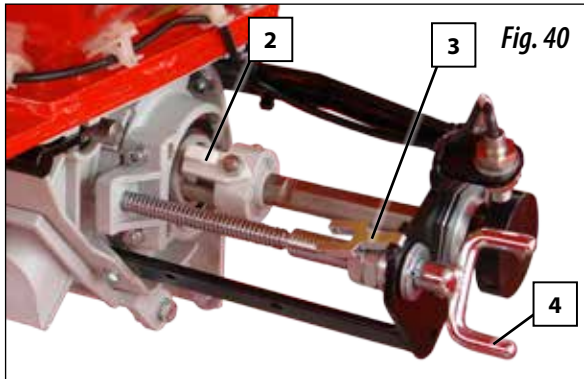

- 1- Remove the locking ring (3, Fig. 40) as shown in the image.
- 2- Place the bolt (2, Fig. 40) as shown in the figure.
- 3- Turn the spindle (4, Fig. 40) for regulating the dose.
- 4- Fix the spindle position placing the locking ring (3, Fig. 40).
- 5- Place the turbine air regulator in **N position** (Fig. 41).
- 6- Fit the gear (8, Fig. 42) with the gear (9, fig. 42), as shown in the image.

6.3.2 SMALL SEEDS (F position)

Follow the steps below for sowing with **SMALL SEEDS**:

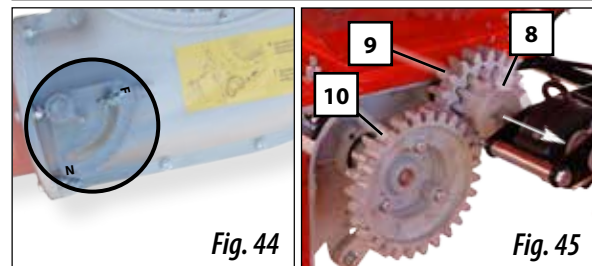
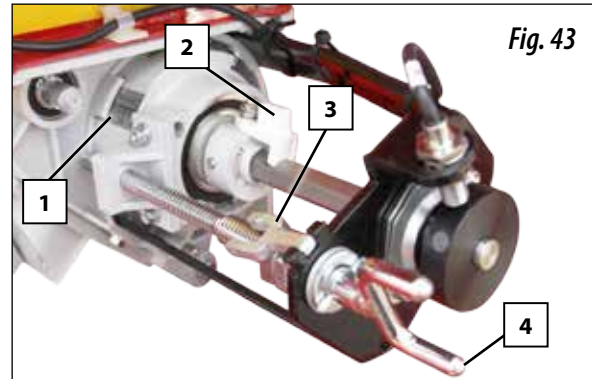

- 1- Remove the locking ring (3, Fig. 43) as shown in the image.
- 2- Place the bolt (2, Fig. 43) in the shaft fitting groove, as shown in the image
- 3- Turn the spindle (4, Fig. 43) for regulating the dose.
- 4- Fix the spindle position placing the locking ring (3, Fig. 43).
- 5- Place the turbine air regulator in **F position** (Fig. 44).
- 6- Pull the gear (8, Fig. 45) until releasing it from the gear (9, Fig. 45) and fit it to the gear (10, Fig. 45).



THE MICRO-DOSAGE SYSTEM ALLOWS BETTER DISTRIBUTING SMALL AND NORMAL SIZED SEEDS IN REDUCED AMOUNTS.



READ THE ADVISABLE VALUE FOR SMALL SEEDS WITH THE F MICRO-DOSAGE SYSTEM IN THE DOSAGE CHARTS (SEE SECTION 10).



CHECK THE CLEANING BRUSH CONDITIONS BEFORE START SOWING SMALL SEEDS.



DO NOT EXCEED THE 25 MEASURE IN THE REGULATION SCALE FOR MICRO-DOSING SMALL SEEDS (1, FIG. 43).



OPEN THE SEED DISPENSER INLET (FIG. 45 BIS).

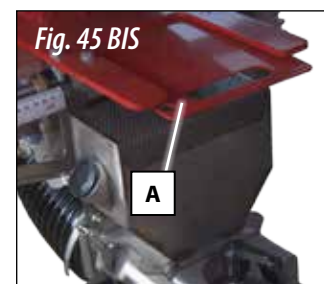

6.4 SEED DOSAGE ADJUSTMENT

Using high quality certified seeds it is not enough to know the weight in kilograms that the machine must distribute, as the final result of the harvest will depend on the number of plants which eventually ripen.

Each plant requires a certain amount of land from which nutrients will be absorbed. Therefore, either low or excessive plant density can be detrimental. To determine the kilograms per hectare to be sown, it is necessary to know the amount of plants that are going to be planted per square metre.

As a guidance, the recommended number of plants per square metre when sowing wheat or barley in non-irrigated land is as follows:

FALL	SPRING
Premature sowing, 200 plants per m ²	Premature sowing, 310 plants per m ²
Late sowing: 265 plants per m ²	Late sowing: 445 plants per m ²

Seed dosing shall be adjusted to each terrain, depending on the texture, fertilizing level, rain gauge measurements, sowing season, grain quality, germinating and tillering power, etc. It shall be taken into account that a seed's germinating power is variable and dependant on multiple factors. It is experimentally calculated to be between 70% and 80%, which is practically equivalent to multiplying the number of grains to be sown by 1,43 or 1,25 respectively.



PLEASE NOTE THAT, IN SPRING, TILLERING IS ALWAYS LOWER AND, THEREFORE, THE SEED AMOUNT TO BE SOWN SHALL INCREASE.



MAQUINARIA AGRÍCOLA SOLA, S.L., RECOMMENDS THE FARMER TO SEEK PROFESSIONAL ADVICE ABOUT THIS SUBJECT, SUCH AS ITG DEL CEREAL, AGRICULTURAL UNION TRADES, ETC.

Below, we describe a practical method to determine the number of kilograms per hectare to be distributed considering the amount of plants per square metre that we want to obtain.

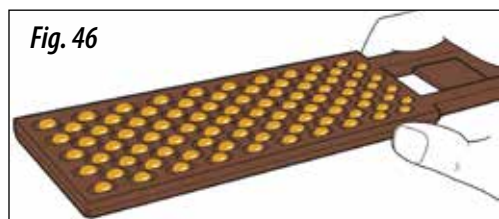

- 1- Introduce the seed counter (Fig. 6.27) inside the seed sack for filling it.
- 2- When taking it out, wipe the seed counter with your hand to make sure that there is only one grain per slot (100 grains in total).

3- Repeat the same procedure 10 more times to obtain 1000 grains

4- Weigh 1000 grains with the precision scales.

The obtained weight in **GRAMS** is called **OPERATIVE WEIGHT**. Once we know the amount of seeds per square metre to be sowed, the kilograms per hectare that must be adjusted with the dosage control are:

$$\text{KILOGRAMS PER HECTARE} = (\text{grains per m}^2 \times \text{OPERATIVE WEIGHT}) / 100$$

6.5 SEED FLOW PRE-TESTING

Once the seed dosage is adjusted (see section 6.3 DOSAGE and 6.4 SEED DOSAGE ADJUSTMENT), a flow test must be carried out to verify that the dose to be sowed is the same as the one indicated in the dosage charts.



FOR PERFORMING THIS PROCEDURE, IT IS NECESSARY THAT THE ENGINE IS OFF AND THE STARTING KEY IS OFF THE IGNITION CONTACT.

A series of previous steps must be performed for carrying out the test:

- 1- FILL THE HOPPER with the seeds.
- 2- COUPLE the machine to the tractor in a slightly elevated position (without the sowing equipment touching the ground).
- 3- Open the venturi injector tap, adjusting the 2 closing clips (1, Fig. 47).

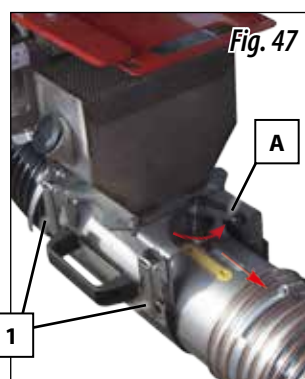

- 4- Turn the handle to release it (A, Fig. 47) and move it until reaching the "NO" position (test position).
- 5- Place the provided sack (2, Fig. 48) or a container under the venturi injector outlet.

ADJUSTMENTS

- 6- Then place the crank (Fig. 49) in the seed driller transmission wheel. Rotate the wheel towards the running direction, as many times as indicated in the following chart according to the machine model.



Fig. 49

MACHINE TYPE	# OF WHEEL ROTATIONS
600	33,3
700	28,6

- 7- Collect and weight the collected seeds with precision.
8- MULTIPLY the weighted result by 40 for obtaining the kilograms per hectare that the machine will distribute with the previously selected opening.

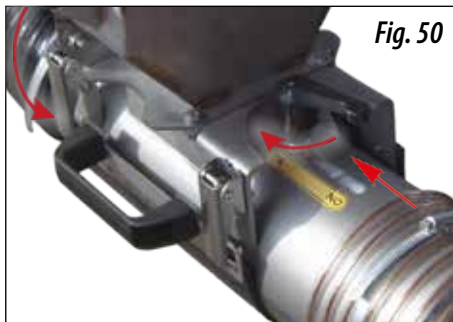

Fig. 50



WHEN FINISHING THE FLOW TESTS, RECLOSE THE VENTURI INJECTOR TAP, PLACE THE HANDLE IN "OK" POSITION AND LOCK IT (FIG. 50).



THE ROTATIONS MUST BE REGULAR, ONE PER SECOND APPROXIMATELY. THE AMOUNT OF ROTATIONS IS APPROXIMATE AND CAN VARY ACCORDING TO THE TERRAIN, THE WHEEL MANUFACTURED OR THE WHEEL PRESSURE; THEREFORE, FIELD TESTING IS ADVISABLE (SEE SECTION 6.6 SEED DOSE FIELD TESTING).



IF THE SEED HAS EXCESSIVE TREATMENT DUSTS, THE FLOW MAY DECREASE; THEREFORE, IT IS ADVISABLE TO PERFORM A SECOND CHECK CONTROL AFTER HAVING DISTRIBUTED APPROXIMATELY THE CONTENT OF THREE HOPPERS.

6.6 SEED DOSE FIELD TESTING

In case of differences between the test and the dose being actually distributed by the machine due to, for instance, very uneven or soft terrain or low-pressured wheel, etc., an experimental test can be performed to determine the **ACTUAL AMOUNT OF ROTATIONS** in the **TRANSMISSION WHEEL**.



Fig. 51

- 1- With a measuring tape, mark the metrical distance in the plot as indicated in the following chart:

MACHINE TYPE	METERS TO COVER
600	41,7
700	35,7

- 2- Mark the wheel for facilitating adding the amount of rotations along the trajectory (Fig. 52).



Fig. 52

- 3- Go over the mentioned distance with the seed driller in operational position. In this way, the real amount of rotations necessary in the previous flow test is determined. Performing the test with this amount of rotations, the kilograms per hectare that the machine actually distribute is determined.



IF THERE IS TOO MUCH DIFFERENCE BETWEEN THE OBTAINED ROTATIONS IN THE FIELD TEST AND THE AMOUNT OF ROTATIONS INDICATED BY THE MANUFACTURED (SECTION 6.5 SEED FLOW PRE-TESTING), MAKE SURE THAT THE TRANSMISSION WHEEL IS ALWAYS IN CONTACT WITH THE FLOATING WHEEL; OTHERWISE, ADJUST THE TENSIONER NUTS (FIG. 52).

6.7 HARROW

The harrow has several settings according to the type of terrain. The settings that can be adjusted are:

HEIGHT

Adjust the lower nut (1, Fig 53).

PRESSURE

Adjust the tensioner upper nut (2, Fig. 53).

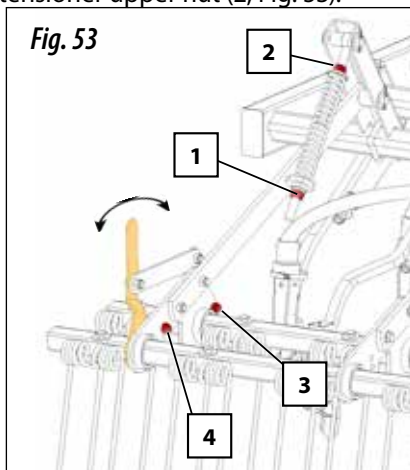

TINE INCLINATION

- 1- Loosen the nut (3, fig. 53).
- 2- Remove screw and nut (4, fig. 53).
- 3- Adjust the handle (yellow, Fig. 53),
- 4- Put the screw and nut (4, fig. 53).

6.8 TRACK ERASERS

The seed driller is fitted with track eraser coulters that can be adjusted in height for erasing the tractor marks. The track markers can be eliminated. To do so, before lowering the sowing equipment to the ground, adjust the stopcock placed in the hopper rear part (see figure 54).

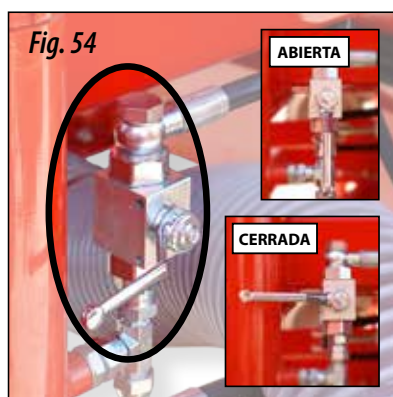

The track eraser coulters' height can be modified; for modifying the depth, adjust the fastening screws, vertically move the coulters and fix them the desired height.



BEFORE FOLDING THE MACHINE FOR TRANSPORT PURPOSES, MAKE SURE THAT THE TRACK ERASER STOPCOCK IS OPEN (FIG. 54).

6.9 LEVELLER

To obtain a regular sowing is fundamental a leveller. The leveller fits with the screws (1, fig. 12) These screws modify the pressure and the height of work



THE BULLDOZER MUST WORK DRAGGING LAND. LAND CAN NOT EXCEED THE SHEET METAL

6.10 HYDRAULIC TRACK MARKERS

Track marker coulters are adjustable in:

- **LENGTH**, horizontal distance between the disc and the outer element.
- Disc **ORIENTATION**, penetration angle.



KEEP THE HYDRAULIC HOSE LINES IN GOOD CONDITION. THE PRESSURE OIL CAN PENETRATE THE SKIN CAUSING SERIOUS INJURIES.



NEVER STAND WITHIN THE UNFOLDING AREA OF THE TRACK MARKER.



IT IS INDISPENSABLE TO FOLD THE TRACK MARKERS WHEN TRANSPORTING THE SEED DRILLER.

ADJUSTMENTS

6.10.1 TRACK MARKER LENGTH ADJUSTMENT

For calculating the horizontal distance BETWEEN THE TRACK MARKER DISC AND THE OUTER COULTER (B, Fig. 57), follow the following formula:

$$B = [A \times (\# \text{ OF COULTERS} + 1) - C] / 2$$

WHERE:

- A** = distance between coulters.
- B** = horizontal distance between the disc and the outer coulters.
- C** = width of tractor trajectory.



B DISTANCE CALCULATED WITH THE PREVIOUS FORMULA IS THE ADJUSTMENT LENGTH UNTIL THE LEFT WHEEL CENTRE OF THE TRACTOR (FIG. 57).



PERFORM THE CALCULATION USING MEASUREMENTS IN CENTIMETRES.

For adjusting the track marker disc distance, follow the following steps:

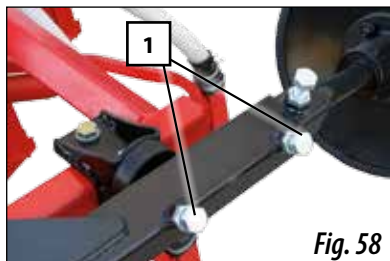

- 1- Loosen the 2 screws (1, fig. 58).
- 2- Place the track marker disc in the previously calculated B distance (**B**= distance between the track marker and the last sowing coulters closer to the track marker)
- 3- Fix the 2 bolts (1, fig. 58) when finishing the operation.

6.10.2 TRACK MARKER DISC INCLINATION ADJUSTMENT

For adjusting the track marker disc inclination, follow the following steps:

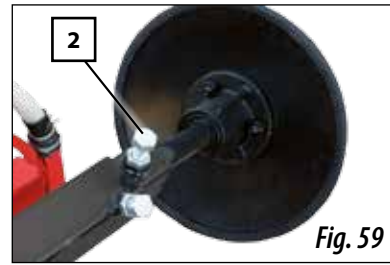

- 1- Loosen the screw (2, fig. 59).
- 2- Regulate the track marker disc inclination for more or less penetration into the ground.
- 3- Tighten the screw (2, fig. 59).



EXCESSIVE DISC ORIENTATION IS NOT ADVISABLE SINCE IT CAN RESULT IN DAMAGE.

6.11 INCLINATION OF FOLDING PARTS

In the support point of the foldable part with the chassis, two adjustable stops allow adjusting the drop angle.

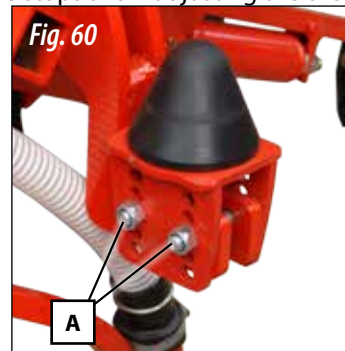

- 1- Loosen the 2 fixing nuts (A, Fig. 60).
- 2- Remove the 2 screws.
- 3- Move the stop until the desired position.
- 4- Introduce the 2 screws and fix them with the 2 nuts (A, Fig. 60).



IN NORMAL SOWING CONDITIONS, IT IS ADVISABLE TO LEAVE THE FOLDABLE PARTS SLIGHTLY DOWNWARDS IN ORDER TO GETTING ADAPTED TO THE TERRAIN IRREGULARITIES. FOR BETTER ADAPTATION TO THE GROUND, LEAVE THE HYDRAULIC SYSTEM OF THE SOWING EQUIPMENT IN NEUTRAL POSITION.



IN HIGHLY CULTIVATED GROUND OR, IN VERY SOFT OR VERY WET SOIL THE FOLDABLE PARTS SHALL BE LEVELLED UNTIL REACHING THE HORIZONTAL POSITION.

7- DISTRIBUTION TYPE



IMPORTANT: MAKE SURE THAT THE TURBINE ROTATES AT THE SAME OPERATIONAL SPEED BEFORE THE TRANSMISSION WHEEL STARTS ROTATING. WHEN STOP SOWING, DO NOT LESSEN THE TURBINE ROTATIONAL SPEED UNTIL DETACHING THE TRANSMISSION WHEEL.

7.1 WITH MECHANICAL DRIVE TURBINE

To guarantee the seed supply to the sowing shoes, it is indispensable that the turbine rotates between 4200 and 4500 rpm; to do so, it is necessary to increase the tractor outlet PTO up to a rotation speed of 1000 m. At lower speed, it is possible that some seeds remain inside the hoses, clogging them.

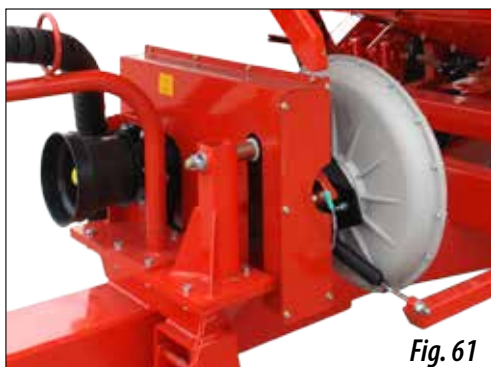

Fig. 61



IF THE SEED DRILLER IS DRAGGED ON THE GROUND WITH THE AIR TURBINE UPWARDS, THE SEEDS GOING OUT FROM THE DISPENSER WILL CLOG THE COLLECTOR HOSE THAT FEEDS THE VENTURI INJECTOR. IN THAT CASE, TAKE THE COLLECTOR OUT AND REMOVE THE SEED BEFORE RESTARTING THE SEED DRILLER.



THE ROTATION OF THE TRANSMISSION WHEEL WITHOUT THE TURBINE IN OPERATION MAY RESULT IN OVERFLOWING COLLECTOR HOSES.

7.2 WITH HYDRAULIC DRIVE TURBINE

MACHINE TYPE	HYDRAULIC ENGINE	
	Absorption capacity (cm ³)	Speed (rpm)
600 and 700	8	4500

MACHINE TYPE	OIL SUPPLY		
	Minimum outlet pressure (bar)	Maximum return pressure (bar)	Oil flow (L/min)
600 and 700	160	1,5	40

CONNECTION

Connect the small hose quick coupling of the turbine to a tractor pressure outlet. Connect the small hose of 1/2" with the large quick coupling to a return without pressure.



MAXIMUM RETURN PRESSURE IS 1.5 BAR. EXCEEDING THIS PRESSURE MAY RESULT IN ENGINE DAMAGE.



Fig. 62

ADJUSTMENT

Turbine rotation speed is controlled by adjusting the tractor hydraulic outlet.

To guaranty the seed supply to the sowing shoes, it is indispensable that the turbine rotates between 4200 and 4500 rpm according to the previous chart. At lower speed, it is possible that some seeds remain inside the hoses, clogging them.



IF OIL GETS TOO HOT BECAUSE THE FLOW PUMPED BY THE TRACTOR IS EXCESSIVE OR THE OIL RESERVOIR IS TOO SMALL, AN ADDITIONAL OIL RESERVOIR IS NECESSARY.



IF THE TRACTOR HYDRAULIC PUMP FLOW IS NOT SUFFICIENT FOR FEEDING THE TURBINE ENGINE OR FOR STARTING ANOTHER NECESSARY ELEMENT, PLACING AN AUXILIARY EQUIPMENT WITH AN ADDITIONAL PUMP ACTIVATED BY THE PTO AND A REFRIGERATED OIL DEPOSIT WILL NECESSARY. CONSULT THE MANUFACTURER REGARDING THE SEED DRILLER OPERATION.

8. SOWING ELECTRONIC CONTROL

8.1 CONTROL PANEL, DESCRIPTION

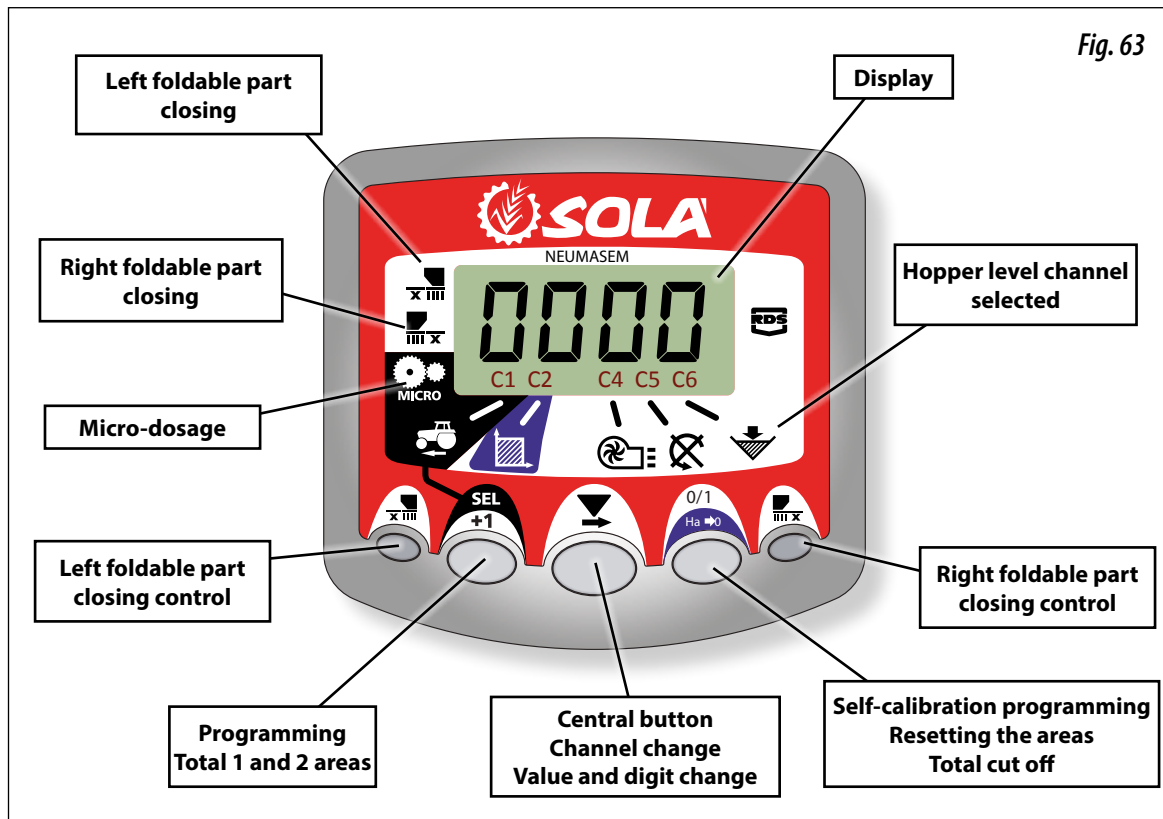

Fig. 63

The factory default settings of the monitor are for the seed driller on which it is mounted. Therefore, it is not necessary to program it, just visualize the values.

The display shows 6 different channels or readings, and 3 situation-indicating arrows.

- C1 indicates the running speed in m/sec.
- C2 indicates two different hectares (for instance, a partial one and a total one).
- C3 unable.
- C4 indicates the turbine rotational speed in rpm.
- C5 indicates the distributor shaft rotational speed in rpm.
- C6 indicates when the seed level in the hopper is too low.

By default, the reading shown on the display is the running speed. When there is any anomaly in any reading, the display shows a flashing «Alarm» indication, a sound alarm is triggered and the channel where the anomaly was produced activates. This alarm will not disappear until the anomaly is not solved.

For visualizing the regarding reading, push the central button and move the corresponding channel. After 10 seconds, the reading automatically goes back to C1.

8.2 RUNNING SPEED -C1



Select the channel by means of the central button. The alarm triggers under the 2.6 Km/h. This alarm can be deactivated entering in the programming mode 2.

Speed sensor calibration

The theoretical calibration is achieved entering the calibration factor in the programming mode 2, according to the value indicated in the following chart.

MACHINE MODEL	6 metres	7 metres
CALIBRATION FACTOR	1,365	1,365

Select the speed channel (C1)

- 1- Push  for entering into the mode 1. Keeping it pushed, push the central button  for changing the digit to modify.
- 2- Keep the central button pulsed during various seconds for modifying the value of the flashing digit.
- 3- The monitor will go back to the normal position when stop pushing the buttons.



NOTE: THERE IS A MORE PRECISE SELF-CALIBRATION MODE FOR THE AMOUNT OF IMPULSES, WHICH REQUIRES A FIELD TEST.

Speed sensor self-calibration

- 1- Mark 100 m
- 2- Select canal 1 (speed).
- 3- Press and keep it pressed . The indication Auto will appear in the display. Stop pressing.
- 4- Run until the 100 meters marked. The monitor counts the sensor impulses.
- 5- When finishing, press again . The monitor has already memorized the amount of impulses.

8.3 TOTAL AREA / SEED DRILLER WIDTH - C2

It is possible to mark two total and independent areas.

Visualization of total area.

- 1- Select canal 2.
- 2- Push to see the total area 1 and total area 2 «tot.1» and «tot.2». The screen will show «tot.1» at first and then its value in Ha.

Resetting the total areas

- 1- Select canal 2.
- 2- Push for visualizing.
- 3- Push the button longer than 5 seconds .

Programming works width

- 1- Select canal 2 of area.
- 2- Push the button longer than 5 seconds until a width value appears on the screen and. holding it pressed, push the central button for modifying the flashing digit.
- 3- Push the flashing digit longer than 3 seconds for modifying its value.
- 4- Stop pushing the buttons for going back to the normal position.

Working in micro mode

When working with the distributor in micro-dosage mode (for small hoppers and small quantities) it is necessary to push the button longer than 3 seconds until the arrow indicating the micro mode appears on the screen. In this case, the monitor will keep the actual work speed and area.

For going back to the normal operation position, once again push longer than 5 seconds until the indicating arrow disappears.

8.4 CONTROL PANEL WITH TRACK MARKER (OPTIONAL)

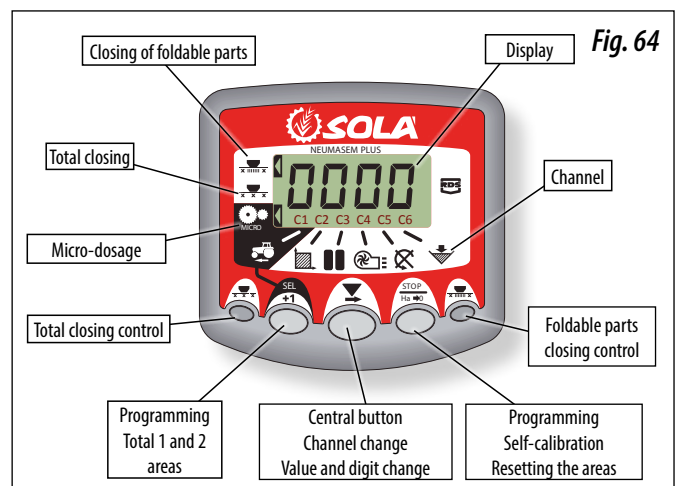

The factory default settings of the monitor are for the seed driller on which it is mounted. Therefore, it is not necessary to program it, just visualize the values.

The display shows 6 different channels or readings, and 3 situation-indicating arrows.

- C1** indicates the running speed in m/sec.
- C2** indicates two different hectares (for instance, a partial one and a total one).
- C3** track marker.
- C4** indicates the turbine rotational speed in rpm.
- C5** indicates the distributor shaft rotational speed in rpm.
- C6** indicates when the seed level in the hopper is too low.

8.5 ROAD TRACKING - C3

The display shows the symbol  after 10 seconds (unless Total Area is selected).

There are 5 road-marking systems: Symmetric mode, asymmetric left mode, asymmetric right mode, 10 runs and 18 runs. The monitor can be programmed from 1 to 15 runs in symmetric and asymmetric modes.

The display shows the current run in the left side and the sequence of runs in the right side. During asymmetric runs, there is a dot on the display.

Manual move forward of the current run

Press  move forward from one run.

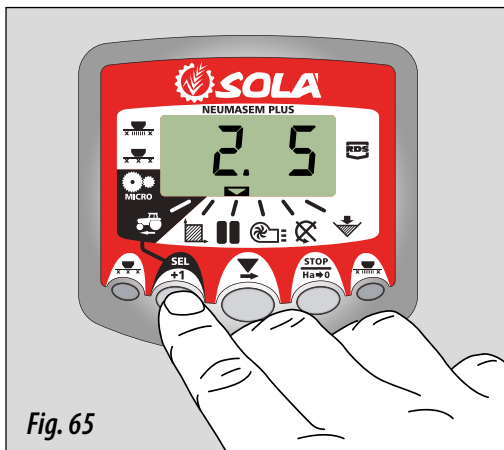



Fig. 65

Stop the run counter.

Press  to stop the run counter. The display will show 'STOP'.

Press  again for going back to the normal work sequence.

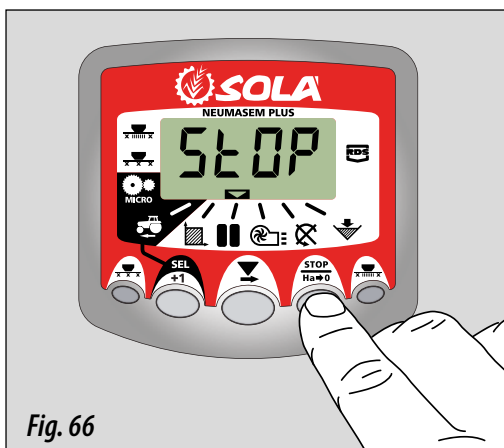

Fig. 66

Asymmetric run sequence

2+2 seed driller outlets will be closed each time the road tracker is activated.

The monitor will emit an intermittent whistle and the display will flash while we are in the road-tracking run.

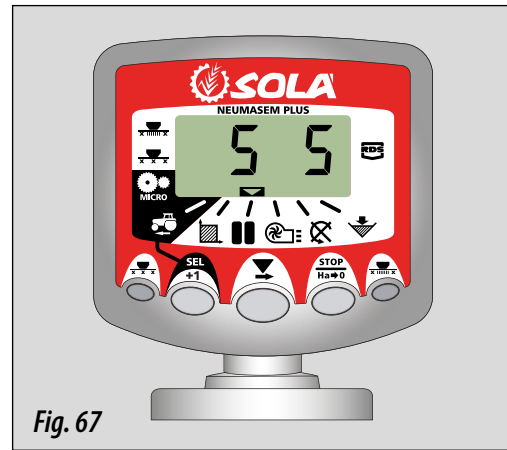

Fig. 67

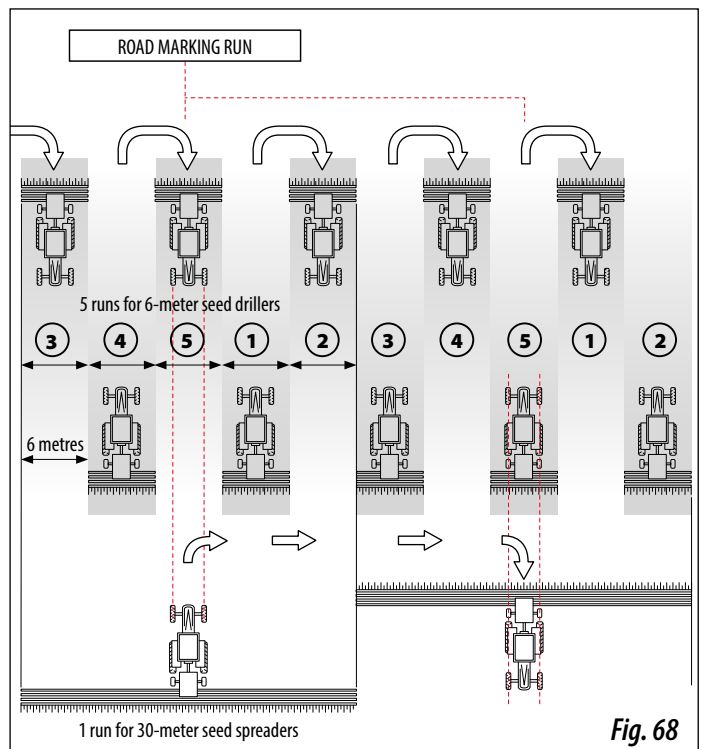

Fig. 68

Left asymmetric sequence

Two outlets on the left side will be closed each time the road tracker is activated. The monitor will emit a whistle and the display will flash while we are in the road-tracking run.

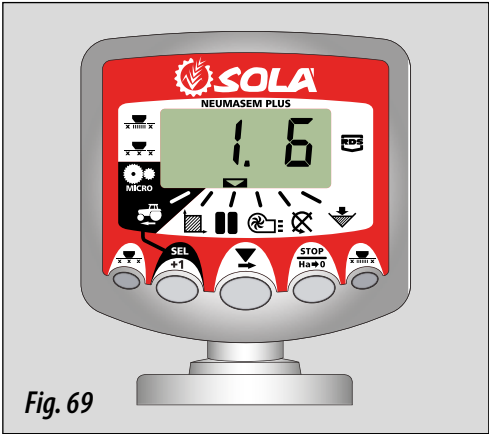

Fig. 69

Right asymmetric sequence

Two outlets on the right side will be closed each time the road tracker is activated. The monitor will emit a whistle and the display will flash while we are in the road-tracking run.

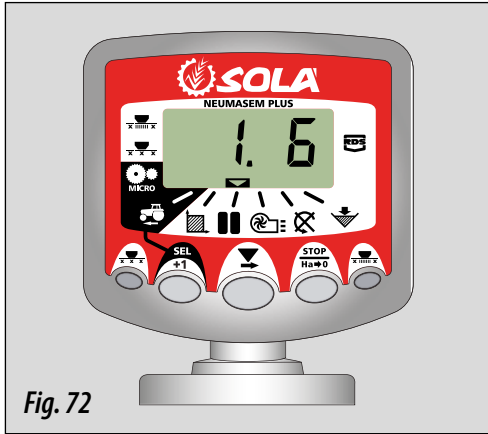

Fig. 72

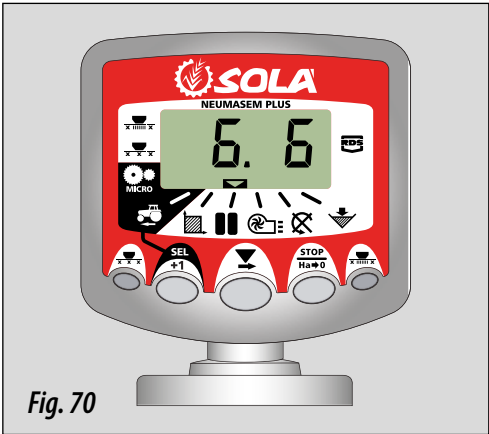

Fig. 70

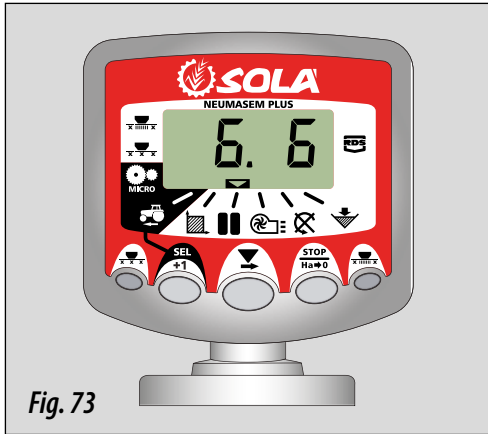

Fig. 73

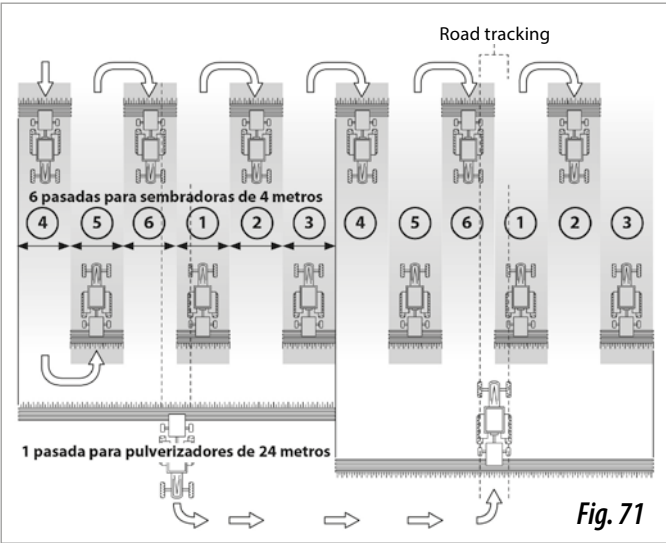

Fig. 71

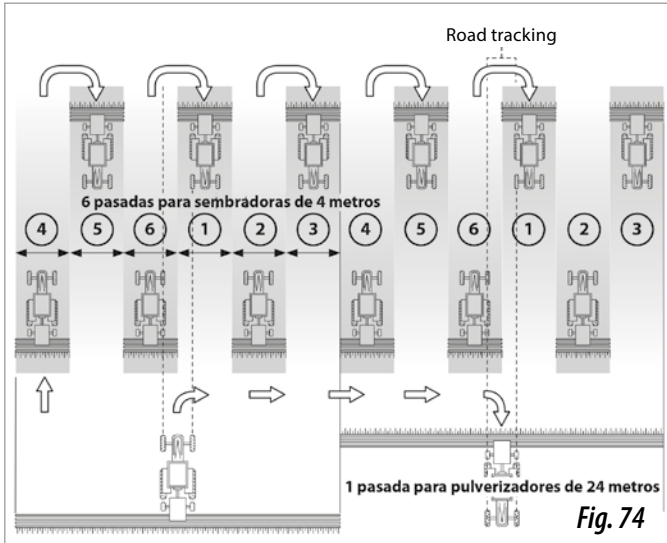

Fig. 74

SOWING ELECTRONIC CONTROL

Sequence of 10 runs

For use with 4-meter seed driller and 10-meter seed spreader, or with 8-meter seed driller and 20-meter seed spreader (2+2 left outlets will close on runs 4 and 7 and, 2+2 right outlets will close on runs 2 and 9). At the beginning of run 1, it is necessary to turn right at the end of the first road.



NOTE: TO RUN LEFT AT THE END OF THE FIRST ROAD, MOVE THE MARKER FORWARD UNTIL NUMBER 6 BEFORE START SOWING.

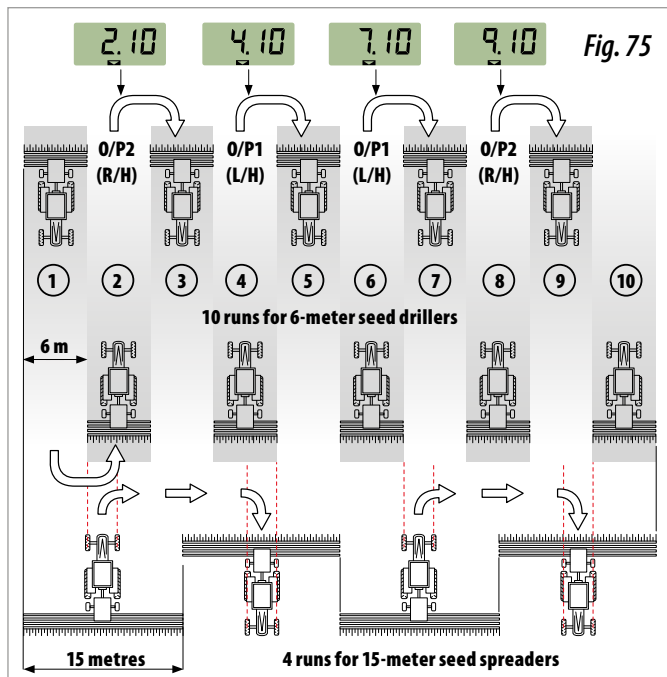

Sequence of 18 runs

For use with 4-meter seed driller and 18-meter seed spreader. (2+2 left outlets will close on runs 3 and 16 and, 2+2 right outlets will close on runs 7 and 12). At the beginning of run 1, it is necessary to turn right at the end of the first road.



NOTE: TO RUN LEFT AT THE END OF THE FIRST ROAD, MOVE THE MARKER FORWARD UNTIL NUMBER 10 BEFORE START SOWING.

The monitor will whistle on the road-marking run.

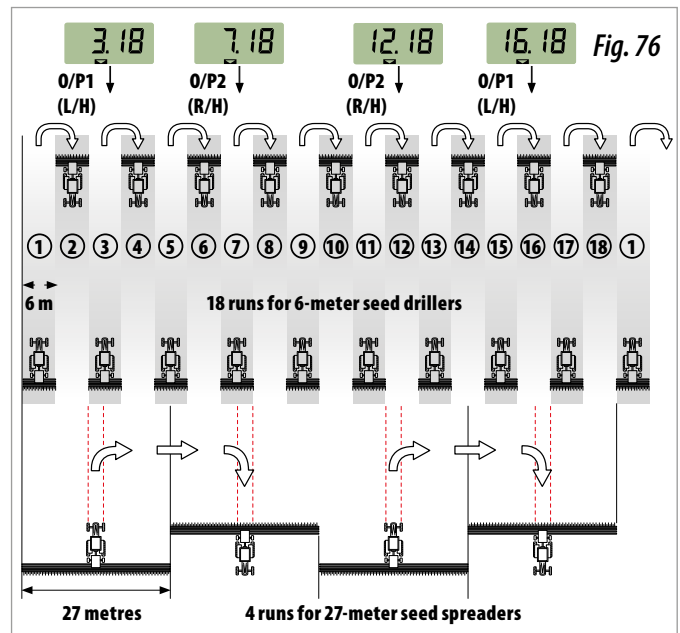

Select the type of sequence

- 1- Select the channel.
- 2- Push entering into mode 1.



After 5 seconds, the first two digits flash indicating the type of sequence:

- 'SY' = Symmetrical
- 'AL' = Asymmetrical left
- 'AR' = Asymmetrical right
- 'AS' = Special asymmetrical with 10 and 18 sequences.

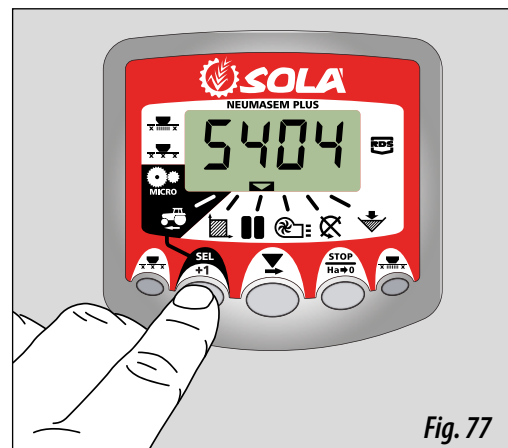
- 3- Keep at the same time and for modifying the sequence.



Select the sequence of runs

- 1- Push  and release for choosing between the type of sequence and the sequence of runs. The third and fourth digits indicate the sequence of runs.
- 2- Push  and hold for choosing between sequence 1 and 15.:

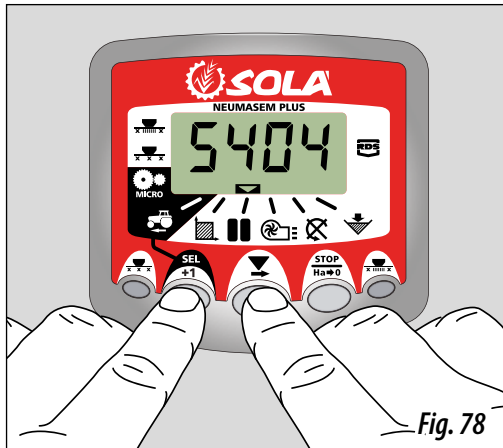



Fig. 78

8.6 TURBINE ROTATIONAL SPEED/ TURBINE ALARM - C4



Visualization of turbine rotational speed

Select channel 4 by means of the central button .

Turbine speed alarms





The minimum turbine rotational speed can be programmed. Alarms are deactivated under 2 Km/h.

Minimum turbine speed

- 1- Select canal 4.
- 2- Push  longer than 5 seconds and keep it pushed.
- 3- Push  for changing the digit and the value as in the previous cases. 3800 rpm. by default
- 4- Stop pushing for going back to the normal position.

Select the amount of pulses per run in the turbine (2 by default).

NOTE: THE AMOUNT OF IMPULSES PER RUN IN THE TURBINE IS ALWAYS 2. USE THIS PROGRAMMING MODE ONLY IN CASE OF ERROR.

- 1- PUSH THE BUTTON  FOR NEUMASEM VERSIONS OR  FOR NEUMASEM PLUS WHILE THE MONITOR IS CONNECTED BY MEANS OF THE REAR SWITCH, FOR ENTERING INTO PROGRAMMING MODE 2.
- 2- PUSH THE BUTTON  FOR NEUMASEM VERSIONS OR  FOR NEUMASEM PLUS FOR CALIBRATING THE CHANNEL AND GO TO CHANNEL 4 (TURBINE).
- 3- PUSH  FOR MODIFYING THE FLASHING DIGIT AND KEEP PUSHING FOR MODIFYING ITS VALUE, (IT MUST ALWAYS BE 2).
- 4- STOP PUSHING FOR GOING BACK TO THE NORMAL POSITION.

8.7 DISTRIBUTOR SHAFT - C5

Select channel 5 by means of the central button .

When the shaft stops rotating, the alarm sounds with 5 non-stop whistles after 40 seconds. If it does not rotate, the alarm is repeated each 30 seconds.



For deactivating the alarm, stop the engine and restart it. This alarm is deactivated under 2 Km/h.

The shaft alarm can be deactivated by pushing the button  for more than 5 seconds in the selected channel. The display shows «Off». In this case, the alarm is not activated even if the engine stops and restarts.

8.8 HOPPER LEVEL ALARM - C6

When the seed level is under the sensor, the alarm activates with 5 non-stop whistles and the display shows «ALA».

Activate and deactivate the hopper level alarm

- 1- Select channel 6 with the button .
- 2- Push the button  continuously and ...
- 3- Push the central button for selecting «0» (unplugged) or «1» (plugged).
- 4- Stop pushing for going back to the normal position.

8.9 TOTAL SEEDING CUT OFF (OPTIONAL)

NEUMASEM monitor

For closing the seed outlet, push the button , the screen shows the flashing text «CORT» (Fig. 79).

For going back to the normal operational position and opening the outlets, push the button . The display shows the flashing text «OPEN» (Fig. 80)

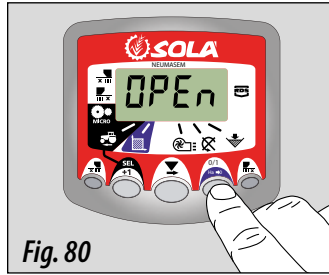
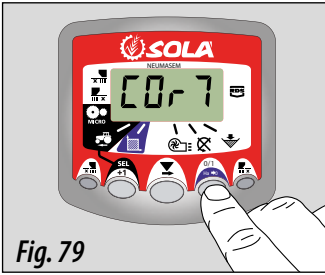

NEUMASEM PLUS monitor

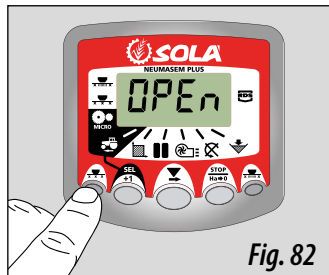
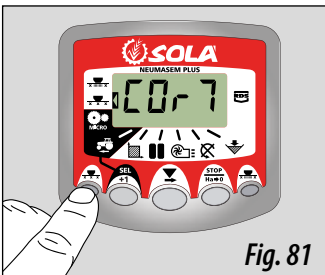

For closing the seed outlet, push the button , the screen shows the indicating arrow and the text «CORT» each 2 seconds (Fig. 81).

For going back to the normal operational position and opening the outlets, push the button . The display shows the flashing text «OPEN» (Fig. 82).





8.10 EXIT CLOSING AT FOLDING PARTS (OPTIONAL)

NEUMASEM monitor

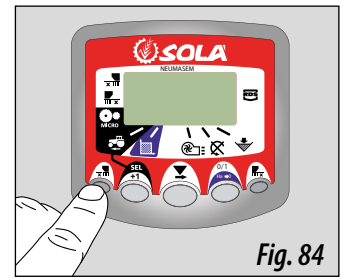
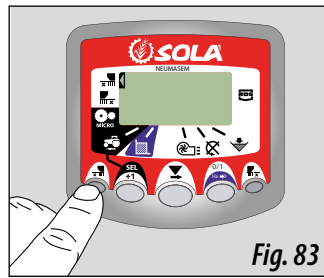

For activating the device that blocks the exit of coulters at the foldable parts, push the button  (the left and right exits at the foldable parts will close). The display will show the indicating arrow (Fig. 83). For going back to the normal position and opening the outlets, push the button  (Fig. 84).



NEUMASEM monitor for INDEPENDENT FOLDABLE PARTS

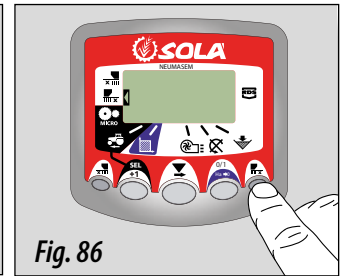
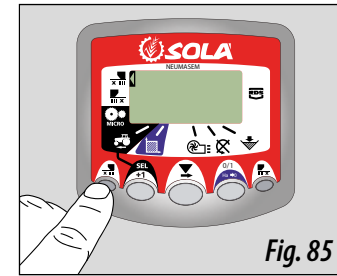

For activating the device that blocks the exit of coulters at the foldable parts, push the button  (for the left side towards the running direction, Fig. 85) or  (for the right side towards the running direction, fig. 86). The display will show the indicating arrow.

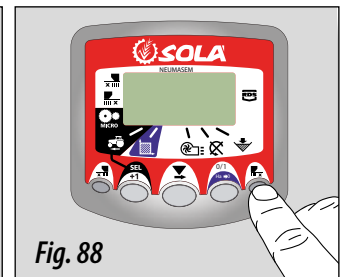
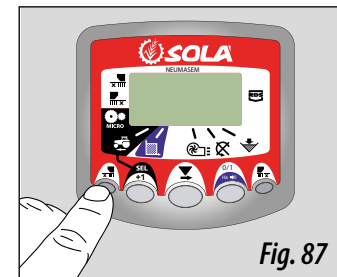

For going back to the normal position and opening the outlets, push the button  or  (Fig. 87 or 88).



NEUMASEM PLUS monitor

For activating the device that blocks the exit of coulters at the foldable parts, push the button . The display will show the arrow indicating the mode being used (Fig. 89). For going back to the normal position and opening the outlets, push the button  (Fig. 90).

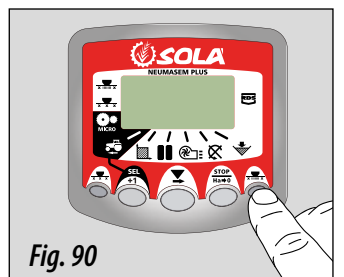
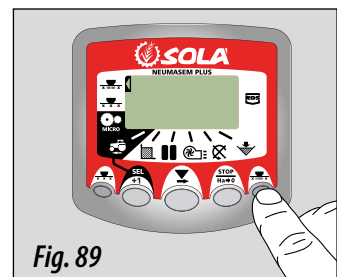

9- MAINTENANCE



IN CASE OF BREAKDOWN, IMMEDIATELY STOP THE MACHINE AND TAKE THE KEY OFF THE IGNITION CONTACT. GET OFF THE TRACTOR AND VISUALLY DETERMINE THE MAGNITUDE OF THE PROBLEM. PERFORM THE NECESSARY PROCEDURES IN THE MACHINE BEFORE RE-STARTING IT.



THE MAINTENANCE OPERATION MUST BE PERFORMED IN DULLY EQUIPPED REPAIR SHOPS, WITH THE MACHINE OFF AND BY QUALIFIED STAFF.



DO NOT PERFORM ANY REPAIR WITHOUT THE NECESSARY KNOWLEDGE. THE HEREIN INSTRUCTIONS MUST BE FOLLOWED, OTHERWISE, CONTACT THE PROVIDER OR EXPERT STAFF.



FOR MACHINE ADJUSTMENT, MAINTENANCE AND REPAIR WORKS, THE USER MUST USE THE ADEQUATE PERSONAL PROTECTION EQUIPMENT, PPE (BOOTS, GLOVES, HEADPHONES, ANTI-DUST MASK AND GLASSES).



AVOID USING CLOSE-FITTING CLOTHES THAT MAY TANGLE IN THE MACHINE MOVABLE ELEMENTS.

Before performing any task in the machine, take into account the following factors:

- Machine maintenance and repair must be carried out in flat and compact ground, with the tractor off and the key out of the ignition contact.
- The chosen lifting device must be adequate for the tasks to be performed. Make sure of complying with the security standards.
- Use the necessary personal protection equipment for each task to perform.
- If using compressed air for cleaning the machine, or if any part must be airbrush painted, it is necessary to use a mask and protection glasses.
- For operations performed in points higher than 1.5 metres from the ground and it is not possible the access through the machine accesses (hopper access ladder), it is necessary to use ladders or, platforms in compliance with the standards in force.
- Long-lasting and/or repeated skin contact with fuel and lubricants may have adverse effects. In case of accidental contact of these products with the eyes or other sensitive parts, thoroughly wash the affected area with water. If swallowed, contact the medical services.

9.1 SERVICE FREQUENCY

Service frequency indicated below is illustrative; it can vary according to the service type and machine use, the environment, temperature, weather factors, etc.

- SEASON START

Check the general machine operation by performing a revision with hopper without seeds.

Verify that the plastic parts are in good condition; the wear of this material due to natural ageing or due to rodents results in damage to these elements.

Make sure that the mechanical components are in good conditions and not rusted.

Clean the parts in contact with seeds or fertilizer, such as hoppers and dispensers.

Make sure that the signalling lights operate correctly.

Verify that the hydraulic circuit fittings and hoses are free from oil leakages.

- PERIODICALLY

Before washing the seed driller with water, make sure that there are no seed or fertilizers inside the hoppers and distributors. After washing, start the turbine for some minutes for extracting the humidity form the pneumatic circuit.

Check the conditions of the screws. Specially, those in contact with the ground. Tight all screws and bolts.

Verify that there is not material remainders, dust, etc., inside the dispenser or the pneumatic circuit. Accumulation of remainders may damage the pneumatic system.

- SEASON END

Dully wash the machine with water; make sure that no seed, fertilizers or any other product remain inside the hopper, distributor and hoses. Specially, wash the parts in contact with chemical products.

Dully lubricate the movable parts of the machine (see section 9.4 LUBRICATION AND GREASING POINTS)

Paint the metallic components that due to work wear have lost the painting.

For correct machine storage, cover it with canvas and storage it in a dry environment.

Thoroughly check all the parts and substitute the damaged or worn ones.



KEEP THE SOWING EQUIPMENT CLEAN; ACCUMULATION OF EARTH, STONES, HERB, ETC., MAY CLOG THE SOWING HOSES.

MAINTENANCE

Good machine maintenance ensures good operation and long-lasting life.



THESE OPERATION MUST BE PERFORMED WITH THE TRACTOR ENGINE FULLY OFF AND WITH THE KEY OFF THE IGNITION CONTACT.

The following chart shows the maintenance tasks to be performed in the machine and their **illustrative frequency**:

ZONE OF INTERVENTION	PROCEDURE TO BE PERFORMED	HOURS			
		20	50	100	500
MACHINE COMPONENTS	Grease all the elements (connecting rods, shafts, bushes, etc.)	X	X		
Wheels	Wheel pressure control			X	
	Verify the joint conditions in the flotation wheels				X
Chain transmissions	Chain lubrication		X		
	Regulation of transmission chain tension				X
Distributor	Lubrication and greasing of transmission components			X	

9.2 SEED DRILLER CLEANING

The seed driller can be washed with a water jet or, preferably, with a high-pressure cleaner. Let the seed driller dry before greasing or lubrication in order to avoid rusting in mechanical parts.

Start the turbine for some minutes for extracting the humidity remaining in the pneumatic circuit.

It is possible that some foreign objects remain clogged inside some machine parts during the works. Take any foreign object out and verify that it has not causes any damage.



WHENEVER YOU CLEAN THE MACHINE WITH COMPRESSED AIR, USE THE CORRESPONDING PERSONAL PROTECTION EQUIPMENT, PPE, (SEE SECTION 9. MAINTENANCE).

9.3 SCREW JOINTS

All seed driller joints must be checked; if necessary tighten the necessary joints.



AFTER THE FIRST 10 MACHINE OPERATION HOURS, IT IS ADVISABLE TO TIGHTEN THE SCREWS.

9.4 LUBRICATION AND GREASING

Any non-painted metallic component is exposed to atmospheric and weather factors, causing oxidation. Therefore, dully lubrication and greasing of these components is important. The machine has stickers with the symbols for the points to GREASE (Fig. 91) and LUBRICATE (Fig. 92).

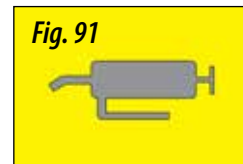

BEFORE LUBRICATING AND GREASING THE MACHINE, WASH THE SEED DRILLER FOR TAKING OUT THE SOIL REMAINING AFTER OPERATION (SEE SECTION 9.1 FREQUENCY OF INTERVENTIONS).



NEVER LUBRICATE THE SEED OR FERTILIZER DISPENSER.



SOME GREASING POINTS MUST BE GREASED AFTER 20 OR 50 OPERATION HOURS. THE NON-COMPLIANCE WITH THESE NORMS MAY DAMAGE THE MACHINE.



USE SOLID CALCIUM GREASE IN GREASING POINTS.



USE HEAVY-DUTY OILS FOR CHAINS IN LUBRICATING POINTS.

GREASE the following points:

- Track markers.
- Bushes in flotation, transmission and depth control wheels.
- Joints
- Transmission components.

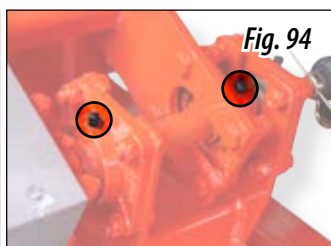
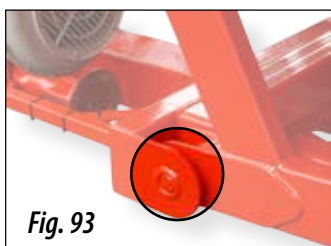

APPLY THE GREASE THROUGH THE GREASING POINTS (Fig. 94).

LUBRICATE the transmission chains (Fig. 95). For accessing to the chain, remove the protection cover.



9.5 TYRE PRESSURE

Control the tyre pressure before using the seed driller.

WHEEL	DESCRIPTION	AIR PRESSURE (bar)
560/45 R22.5	FLOTATION WHEEL	3.3
4.00 - 8	TRANSMISSION wheel	2.1
18x7" - 8" 14PR	DEPTH CONTROL wheel	3.75

Generally, on poorly prepared ground, it is advisable to diminish the pressure in the flotation and depth control tyres for absorbing the ground unevenness and achieve more sowing regularity.

10. DOSAGE CHART

Dosage charts are expressed in Kg./Ha that the machine will distribute according to the dispenser regulation (see section 6.3 DOSAGE



THE AMOUNTS INDICATED IN THE CHARTS MUST BE CONSIDERED AS ILLUSTRATIVE, SINCE THE FLOW MAY VARY DUE TO THE EVENTUAL PRESENCE OF DISINFECTANT DUST, THE VARIATION IN SEED SIZE, FERTILIZER PARTICLE SIZE, DENSITY, WEIGHT, HUMIDITY, ETC.



FOR A PRECISE LABOUR, FOLLOW THE DOSAGE PROCEDURE DESCRIBED IN SECTION 6 OF THIS MANUAL.

10.1 SEED CHART

MICRO - 6 METRES								
SMALL SEED	COLZA		RED CLOVER		HERB		TURNIP	
SPEC. WEIGHT (Kg/L)	0.65		0.77		0.39		0.7	
Gauge Pos.	SMALL SEED (kg/ha)							
2,5	1,93	0,97	2,06	1,05	-	-	2,31	1,09
5	4,12	2,06	4,73	2,31	-	-	4,12	2,18
7,5	6,18	3,03	7,76	3,88	2,54	1,27	6,78	3,35
10	8,24	4,12	10,94	5,45	4,73	2,31	9,09	4,54
12,5	10,26	5,21	13,97	6,91	6,55	3,27	11,43	5,70
15	12,51	6,18	16,32	8,24	8,36	4,18	13,58	6,78
17,5	14,46	7,15	19,25	9,58	10,16	5,09	15,83	7,94
20	16,51	8,24	21,79	10,94	12,02	5,94	18,18	9,09
22,5	18,66	9,33	24,14	12,02	13,58	6,78	19,54	9,76
25	20,72	10,26	24,92	12,51	14,76	7,39	20,91	10,46

MICRO - 7 METRES								
SMALL SEED	COLZA		RED CLOVER		HERB		TURNIP	
SPEC. WEIGHT (Kg/L)	0.65		0.77		0.39		0.7	
Gauge Pos.	SMALL SEED (kg/ha)							
2,5	1,66	0,83	1,77	0,90	-	-	1,98	0,94
5	3,53	1,77	4,05	1,98	-	-	3,53	1,87
7,5	5,29	2,60	6,65	3,33	2,18	1,09	5,81	2,87
10	7,06	3,53	9,38	4,67	4,05	1,98	7,79	3,89
12,5	8,79	4,46	11,98	5,92	5,61	2,81	9,80	4,88
15	10,72	5,29	13,99	7,06	7,17	3,58	11,64	5,81
17,5	12,40	6,13	16,50	8,21	8,71	4,36	13,57	6,81
20	14,16	7,06	18,68	9,38	10,30	5,09	15,58	7,79
22,5	16,00	8,00	20,69	10,30	11,64	5,81	16,75	8,37
25	17,76	8,79	21,36	10,72	12,65	6,33	17,92	8,96

DOSAGE CHART

When the sowing dose (kg/ha) is too small (gauge position ≤ 10), it is possible to get a more uniform sowing by means of the micro-dosage, even at the edge of the normal sowing (cereal and big seeds).

6 METRES											7 METRES											
NORMAL SEED	WHEAT	RYE	BARLEY	OAT	EDIBLE BEAN	PEAS	LUPINE	CAROB	CORN	HERB	NORMAL SEED	WHEAT	RYE	BARLEY	OAT	EDIBLE BEAN	PEAS	LUPINE	CAROB	CORN	HERB	
WEIGHT SPEC. (Kg/L)	0,77	0,74	0,68	0,5	0,85	0,81	0,76	0,83	0,79	0,36	WEIGHT SPEC. (Kg/L)	0,77	0,74	0,68	0,5	0,85	0,81	0,76	0,83	0,79	0,36	
Pos. Gauge	NORMAL SEED (kg/ha)										Pos. Gauge	NORMAL SEED (kg/ha)										
5	-	-	-	-	-	-	-	-	-	-	5	-	-	-	-	-	-	-	-	-	-	-
10	30,3	30,3	29,1	21,5	20,5	19,3	25,4	29,1	7,3	-	10	26,0	26,0	25,0	18,4	17,6	16,6	21,8	25,0	6,2	-	-
15	46,0	44,9	43,6	31,3	37,5	36,4	41,2	46,0	21,8	17,0	15	39,5	38,4	37,4	26,8	32,2	31,2	35,3	39,5	18,7	14,6	-
20	63,0	60,6	58,1	42,0	55,7	53,4	55,7	63,0	42,4	23,1	20	54,0	51,9	49,8	36,0	47,7	45,7	47,7	54,0	36,4	19,8	-
25	77,7	75,1	71,5	51,8	71,5	70,3	71,5	81,2	63,0	30,3	25	66,6	64,4	61,3	44,4	61,3	60,2	61,3	69,6	54,0	26,0	-
30	94,5	90,9	86,0	64,5	88,4	88,4	87,3	97,7	83,6	37,5	30	81,0	77,9	73,7	55,3	75,8	75,8	74,8	83,8	71,7	32,2	-
35	111	107	101	74,3	106	107	103	115	105	44,9	35	95,5	91,3	86,3	63,7	90,5	91,3	87,9	98,8	89,6	38,4	-
40	127	121	115	85,0	122	123	117	132	125	-	40	109	104	98,8	72,9	105	106	101	113	107	-	-
45	143	137	130	95,8	140	141	133	150	142	-	45	122	117	111	82,1	120	121	114	129	121	-	-
50	157	152	145	107	156	157	150	167	158	-	50	135	131	124	91,3	134	135	128	143	136	-	-
55	175	167	157	117	173	176	165	184	176	-	55	150	143	135	101	148	151	142	157	151	-	-
60	191	182	173	128	191	193	180	201	193	-	60	163	156	148	110	163	166	154	173	165	-	-
65	207	197	187	140	207	211	196	219	210	-	65	178	169	160	120	178	181	168	188	180	-	-
70	224	213	201	150	224	228	212	236	227	-	70	192	183	173	129	192	195	182	203	194	-	-
75	240	229	216	161	241	244	228	253	242	-	75	206	196	185	138	207	209	195	217	208	-	-
80	256	244	229	172	257	262	243	271	259	-	80	219	209	196	147	220	224	209	232	222	-	-
85	271	261	243	182	274	281	259	287	277	-	85	232	224	209	156	235	241	222	246	237	-	-
90	287	274	258	193	291	298	274	305	293	-	90	246	235	221	165	250	255	235	261	251	-	-
95	304	289	273	203	307	315	291	322	310	-	95	260	248	234	174	263	270	250	276	266	-	-
100	320	305	287	214	323	332	305	339	327	-	100	274	261	246	183	277	285	261	291	281	-	-
105	335	321	302	226	339	350	321	358	345	-	105	287	276	259	193	291	300	276	307	296	-	-
110	352	337	317	236	358	367	337	374	362	-	110	302	289	271	203	307	315	289	321	310	-	-

SEED FLOW PRE-TESTING	
SEED DRILLER	WHEEL TURNS
600	33,3
700	28,6

10.2 MICRO-GRANULATED FERTILIZER CHART (OPTIONAL)

This equipment for micro-granulated fertilizer has various dispensers; the following chart shows the values distributed by both dispensers. These can be regulated by turning the wheel (1, Fig. 96).

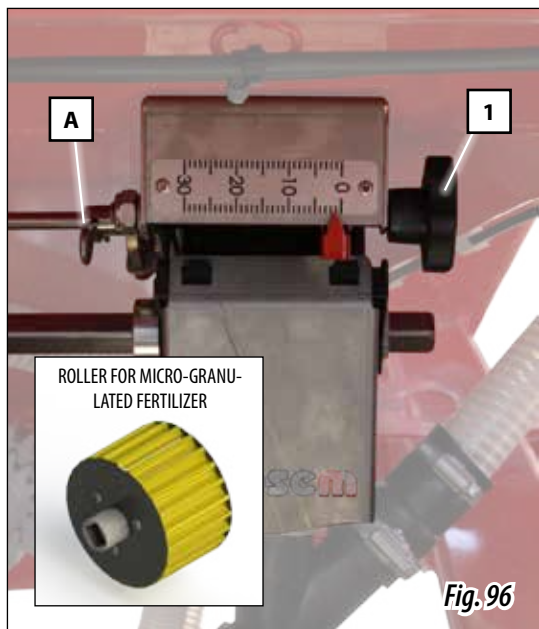

		WORKING WIDTH				
		6 (metres)		7 (metres)		
		WORKING SPEED				
		8 - 10 Km/h	12 - 14 Km/h	8 - 10 Km/h	12 - 14 Km/h	
DISPENSER POSITION	5	23,8	22,1	20,3	19,0	(kg/ha)
	10	33,3	31,7	28,6	27,2	
	15	43,7	42,2	37,6	36,2	
	20	52,6	50,9	45,0	43,7	
	25	55,0	55,0	47,2	47,2	
	30	56,4	56,0	48,3	48,0	
		(kg/ha)				

*Reference fertilizer: Agristar Complet (specific weight: 0,99 Kg/dm³).



WHEN FERTILIZING WITH AMOUNTS **LOWER THAN THOSE SPECIFIED IN THE CHART**, DISCONNECT ONE DISPENSER PROCEED AS FOLLOWS: FULLY CLOSE THE DISPENSER, REMOVE THE CONNECTION PIN (A, FIG. 96) AND, THEN, REGULATE THE DOSAGE (DIVIDE BY TWO THE VALUES IN THE PREVIOUS CHART).

10.3 NORMAL FERTILIZER CHART (OPTIONAL)

This equipment for normal fertilizer has various dispensers; the following chart shows the values distributed by both dispensers. These can be regulated by turning the wheel (1, Fig. 97).

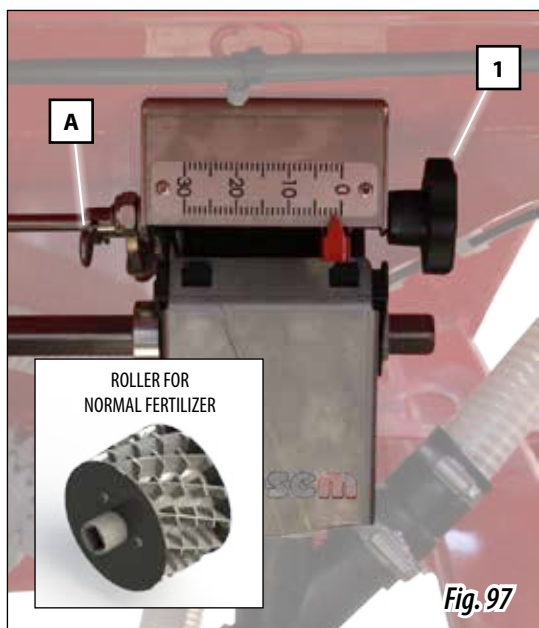

		WORKING WIDTH		
		6 (metres)	7 (metres)	
DISPENSER POSITION	5	33	28	(kg/ha)
	10	63	54	
	15	92	79	
	20	122	105	
	25	152	131	
	30	182	156	
		(kg/ha)		

*Reference fertilizer: compost fertilizer (spec. weight 1,00 Kg/dm³).



WHEN FERTILIZING WITH AMOUNTS **LOWER THAN THOSE SPECIFIED IN THE CHART**, DISCONNECT ONE DISPENSER PROCEED AS FOLLOWS: FULLY CLOSE THE DISPENSER, REMOVE THE CONNECTION PIN (A, FIG. 96) AND, THEN, REGULATE THE DOSAGE (DIVIDE BY TWO THE VALUES IN THE PREVIOUS CHART).

DOSAGE CHART

11- GUARANTEE

MAQUINARIA AGRÍCOLA SOLÀ, S.L. warrants the correct operation of the sold material according to the technical specifications of the GUARANTEE CERTIFICATE included in each machine. Any dispatch note delivered with the machine correspond to an invoice. If the BUYER considers that the merchandise is covered by the guarantee and it should not have been billed, the problem will be analysed and, if considered appropriate, a credit will be made. The guarantee is subordinated to the return of the GUARANTEE CERTIFICATE duly completed by the DEALER and the FINAL BUYER.

MAQUINARIA AGRÍCOLA SOLÀ, S.L., is not liable for any circumstances of misuse or lack of verification of the proper operation of the entire material at the time of commissioning, or during the course of agricultural work season (see section 3.4 USAGE ACCORDING TO DESIGN).

The DEALER or FINAL BUYER, or, if applicable, the USER, may not claim in any case any compensation from MAQUINARIA AGRÍCOLA SOLÀ, S.L. for any damage, costs of labour or transport, faulty work, material or body injury, or decrease or crop losses, etc.

Returns or exchanges of material shall always be borne by the buyer and with our prior permission. Optional extras and spare parts that have passed the three months since delivery, or custom-made, will be accepted in exceptional circumstances. All guarantee parts must be returned to the factory for control and eventual change with a note describing the problem, the serial number of the machine and model. The guarantee is subordinated to the decision of MAQUINARIA AGRÍCOLA SOLÀ, S.L. Repairs that have not been authorized by MAQUINARIA AGRÍCOLA SOLÀ, S.L. will not be considered as guarantee covered.

MAQUINARIA AGRÍCOLA SOLÀ, S.L.

Ctra. de Igualada, s/n. Apdo. Correos, 11
08280 CALAF (Barcelona) **SPAIN**

Tel. 34 93 868 00 60

Fax. 34 93 868 00 55

www.solagrupo.com

E-mail: sola@solagrupo.com