

ARES-2713

STARTING MANUAL MAINTENANCE DOSAGE

Please read and follow this operating manual before putting the machine into operation.



SOLÁ seed drills and fertilizer spreaders are manufactured in a highly specialized environment and our factory has a vast customer-endorsed experience.

SOLÁ machines use highly advanced technology and are guaranteed to work without malfunctions in a great variety of conditions. They are provided with easy-to-use and efficient devices.

SOLÁ machines perform excellently with only minimum operator maintenance.

*This manual will help you use your **SOLÁ** product with the upmost efficiency.*



Certified quality system

1ST Edition – April 2015
Ref.: CN-811082/GB
Created by: INTEGRUM

It is forbidden to copy any part of this manual.
Specifications are subject to change or modification without notice.
The pictures included do not necessary show the standard version.

TABLE OF CONTENTS

1- INTRODUCTION	5
2. SAFETY INSTRUCTIONS	6
2.1 SAFETY SYMBOLS.....	6
2.2 USE ACCORDING TO DESIGN	8
2.3 GENERAL SAFETY INSTRUCTIONS	8
3- ESSENTIAL SOWING CONCEPTS	10
3.1 TERRAIN	10
3.2 THE SEED	10
3.3 SEED PLANTING DEPTH.....	10
4. STARTING	13
4.1 COUPLING THE SEED DRILL.....	13
4.2 HYDRAULIC CONNECTIONS.....	14
4.3 HYDRAULIC SYSTEM	15
4.4 TRANSPORT POSITION.....	17
4.5 LOADING THE SEED DRILL MANUALLY	18
4.6 LOADING THE SEED DRILL USING A WORM SCREW	18
4.7 THE BUILT-IN SUPPORTING LEGS	19
5. DOSAGE	20
5.1 REGULAR SEEDS (POSITION N)	22
5.2 FINE SEEDS (MICRODOSING – POSITION F).....	23
5.3 PREVIOUS FLOW TEST	25
5.4 COMPLEMENTARY CHECKING TESTS	28
5.4.1 TEST TO DETERMINE THE NUMBER OF WHEEL TURNS.....	28
5.4.2 SEED DOSING ADJUSTMENTS	29
6- ADJUSTING SEED PLANTING DEPTH	31
6.1 ADJUSTING RATCHETS AND SPINDLES	31
6.2 INCLINATION OF THE FOLDING PARTS	32
6.3 EQUIPMENTS WITH TINE COULTERS	33
6.4 HARROW	34
6.5 HYDRAULIC TRACK MARKERS	35
6.5.1 ADJUSTING TRACK MARKER'S LENGTH	36
6.5.2 ADJUSTING TRACK MARKER'S INCLINATION	37
7- TYPES OF DISTRIBUTION	38
7.1 SEED DISTRIBUTION BY MECHANICAL FAN.....	38
7.2 SEED DISTRIBUTION BY HYDRAULIC FAN.....	39
8- ELECTRICAL CONTROLLER	40
8.1 FRONT PANEL DESCRIPTION.....	40
8.2 FORWARD SPEED – C1	41
8.3 TOTAL AREA / SEED DRILL WIDTH – C2.....	42
8.4 CONTROL PANEL WITH TRACK MARKER (OPTIONAL).....	44
8.4.1 TRAMLINING - C3	45
8.5 FAN RPM / FAN ALARMS – C4	52
8.6 SEED SHAFT RPM – C5.....	53
8.7 HOPPER LOW LEVEL ALARM – C6	53
8.8 TOTAL SOWING SHUT-OFF (OPTIONAL)	54
8.9 SHUT-OFF SOWING FROM FOLDING PARTS (OPTIONAL).....	55

9- MAINTENANCE57
 9.1 LUBRICATION57
 9.2 SCREWS57
 9.3 DISTRIBUTOR HEAD AND SEED HOSES.....58
10- DOSAGE TABLE59
11- NOTES61

1- INTRODUCTION

It is essential to read and follow the instructions and recommendations in this manual before operating the seed drill **ARES-2713**. Careful reading enables maximum operator efficiency, prevents accidents and damage, and increases the seed drill's capacity and life expectancy.

El manual deberá ser leído por toda persona que realice tareas de operación (incluyendo preparativos, reparación de averías en el campo y cuidado general de la máquina), mantenimiento (inspección y asistencia técnica) y transporte.

Please ensure that this manual has been read by any person involved in performing **operational tasks**, (including preparation, dealing with mechanical problems and supervising the machine), **maintenance** (inspection and technical assistance) and **transport**.

For your safety, please follow these technical safety instructions as **SOLÀ** will not be responsible for damages caused by not observing the information provided.

In the first chapters you will find the Technical Characteristics and Safety Instructions, as well as some essential sowing concepts. Basic concepts that are required to operate the machine are explained in the Starting and Maintenance sections.

The last part of this manual consists of Dosage Tables, detailed by seed type.



SOLÀ RETAINS THE RIGHT TO MODIFY ILLUSTRATIONS, TECHNICAL DATA AND WEIGHTS INDICATED IN THIS OPERATING MANUAL, IF THESE CHANGES HELP TO IMPROVE THE QUALITY OF THE SEED DRILLS.

In this operating manual you will find three different symbols relating to safety:



TO WORK MORE EASILY WITH THE SEED DRILL.



TO PREVENT DAMAGE TO THE SEED DRILL AND OPTIONAL EQUIPMENT.



TO PREVENT PHYSICAL INJURY.

2. SAFETY INSTRUCTIONS

2.1 SAFETY SYMBOLS

On the machine you will find the following warning pictograms:



READ THE INSTRUCTIONS CAREFULLY AND OBSERVE THE SAFETY ADVICE GIVEN IN THE OPERATING MANUAL.



DURING THE COUPLING MANOEUVRE, STAY AWAY FROM THE REAR PART OF THE TRACTOR.
RISK OF SERIOUS PHYSICAL INJURY.



DANGER OF INFECTION FROM ESCAPING HYDRAULIC FLUID AT HIGH PRESSURE! THIS CAN INFLICT SERIOUS INJURIES WITH POTENTIALLY FATAL CONSEQUENCES IF IT PASSES THROUGH THE SKIN AND INTO THE BODY.
KEEP THE HOSE LINES IN GOOD CONDITION.
RISK OF SERIOUS PHYSICAL INJURY.



NEVER STAND UNDER THE SOWING EQUIPMENT OR SWIVEL AREA OF THE MACHINE'S EXTENSION TINE COULTERS.
RISK OF SERIOUS PHYSICAL INJURY.



WHILE MAINTAINING OR REPAIRING THE SEED DRILL, STOP THE TRACTOR'S ENGINE AND PREVENT IT FROM STARTING. THE IGNITION KEY MUST BE REMOVED.



IT IS FORBIDDEN TO RIDE ON THE MACHINE DURING OPERATION.
RISK OF SERIOUS PHYSICAL INJURIES.



RISK OF BEING CRUSHED WHEN WORKING UNDER THE MACHINE, PLEASE SECURE THE MACHINE TO PREVENT THIS RISK.

RISK OF SERIOUS PHYSICAL INJURIES.



THE DIRECTION AND SPEED THAT THE PTO SHAFT TURNS (ONLY IN MACHINES EQUIPPED WITH MECHANICAL FAN).

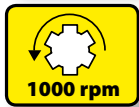

NEVER STAND UNDER THE TRACK MARKERS NOR INSIDE THEIR ACTION AREA.

RISK OF SERIOUS PHYSICAL INJURIES.



COUPLING POINT FOR TRANSPORTATION BY CRANE.

2.2 USE ACCORDING TO DESIGN

- The Seed Drill **ARES-2713** has been designed for cereal and other kind of grain seeds.
- If the machine is used in circumstances other than the above, the manufacturer will not be held responsible for any damage caused.
- The user must observe all regulations concerning safety, traffic and hygiene.
- If the machine is modified by the user, the manufacturer's warranty is cancelled. **SOLÁ** will not be held responsible for any damage caused.

2.3 GENERAL SAFETY INSTRUCTIONS



- BEFORE STARTING THE MACHINE, PLEASE CHECK THE MACHINE IS IN GOOD CONDITION FOR WORK AND IS SAFE FOR ROAD USE.



- CHECK THAT VISIBILITY IS CLEAR AROUND THE MACHINE AND THERE IS NO PERSON IN THE WORKING AREA.



- IN THOROUGHFARE, PLEASE OBSERVE TRAFFIC SIGNS AND REGULATIONS.



- IT IS FORBIDDEN TO RIDE ON THE MACHINE OR CLIMB INTO THE MACHINE WHEN IT IS RUNNING.



- BEFORE USING THE MACHINE, THE USER MUST BE FAMILIAR WITH ALL OPERATING ELEMENTS.



- PLEASE BE EXTREMELY CAREFUL WHEN COUPLING AND UNCOUPLING THE MACHINE TO THE TRACTOR.



- PLEASE CHECK THAT THE PTO SHAFT IS IN GOOD CONDITION AND WELL PROTECTED. PREVENT THE PROTECTIVE TUBE FROM TURNING BY HOLDING BOTH THE TUBE AND CHAIN PROVIDED FOR THIS PURPOSE.



- MOUNT THE PTO SHAFT'S TRANSMISSION ONLY WHEN THE TRACTOR'S ENGINE IS OFF.



- BEFORE CONNECTING THE PTO SHAFT, BE SURE THAT THE DANGER ZONE SURROUNDING THE MACHINE IS CLEAR.



- NEVER LEAVE THE TRACTOR'S DRIVER'S SEAT WHILE THE MACHINE IS IN OPERATION.



- DO NOT DEPOSIT EXTERNAL ELEMENTS INSIDE THE HOPPER.



- WHEN MAINTAINING THE HYDRAULIC SYSTEM OF THE SEED DRILL, MAKE SURE THAT IT IS DEPRESSURISED AND THE TRACTOR'S ENGINE IS OFF.



- PLEASE REGULARLY CHECK THE CONDITION OF THE TUBES AND HOSEPIPES IN THE HYDRAULIC SYSTEM. THESE PARTS AGE NATURALLY AND THEIR LIFE SHOULD NOT SURPASS 6 YEARS. PLEASE REPLACE WHEN NECESSARY.



- WHEN RAISING THE SEED DRILL, THE FRONT AXLE IS UNLOADED. ENSURE THAT THE MACHINE HAS ENOUGH LOAD TO PREVENT IT OVERTURNING. AT THIS TIME YOU MUST ENSURE THAT THE CONDITION OF BOTH THE STEERING AND THE BRAKES IS OPTIMAL.



- DURING TRANSIT WITH THE RAISED SEED DRILL, BLOCK THE LOWERING SWITCH. BEFORE LEAVING THE TRACTOR, LOWER THE SEED DRILL ONTO THE GROUND AND REMOVE THE TRACTOR'S STARTING KEY.



- ALWAYS USE ENOUGH SUPPORTING ELEMENTS WHEN MAINTAINING THE MACHINE IN A RAISED POSITION TO PREVENT THE MACHINE FROM LOWERING OR FALLING.

3- ESSENTIAL SOWING CONCEPTS

3.1 TERRAIN



THE BETTER THE SOIL CONDITION, THE BETTER THE SOWING QUALITY. WORK IS MORE DIFFICULT ON BIG CLOUDS OR UNEVEN FURROWS.

Although **SOLÀ** machines resist harsh conditions, if the seedbed does not satisfy appropriate conditions then the sowing quality will suffer.

3.2 THE SEED



IT IS ESSENTIAL THAT SEEDS ARE WELL MAINTAINED AND CLEAN. BARLEY SEEDS SHOULD BE TRIMMED.

3.3 SEED PLANTING DEPTH



THE RECOMMENDED SEED PLANTING DEPTHS ARE FROM 3 TO 5 CENTIMETRES. PLANTING TOO DEEP CAUSES PROBLEMS AS RHIZOME CANNOT REACH THE SURFACE AND THE PLANT WILL DIE. IT DOES NOT MATTER THAT SOME GRAINS ARE VISIBLE BECAUSE THE HARROW'S. TINES WILL COVER THEM EVENTUALLY.

The seed planting depth has consequences for tillering, as well as for the plant's strength and its ability to resist frostbite or drought. The parent shoot grows from 1 to 2 cm under the ground, whatever the depth of the seed.

Planting deeper does not necessarily mean getting deeper roots. Only a few roots grow from the lower part of the seed. Most of them grow from a parent shoot close to ground level.

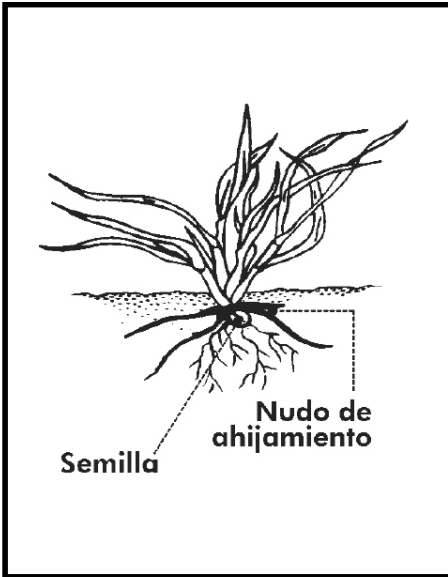

Normal Planting Depth: from 2 to 4 cm

Thick stem, short rhizome and resistant to frostbite.

Multiple tillering providing from 3 to 6 shoots and a lot of blades, from 6 to 10.

Deep and thick roots, approximately 5 cm in width and 10-12 cm in depth.

With less grains per sowing square metre, more ears are obtained.

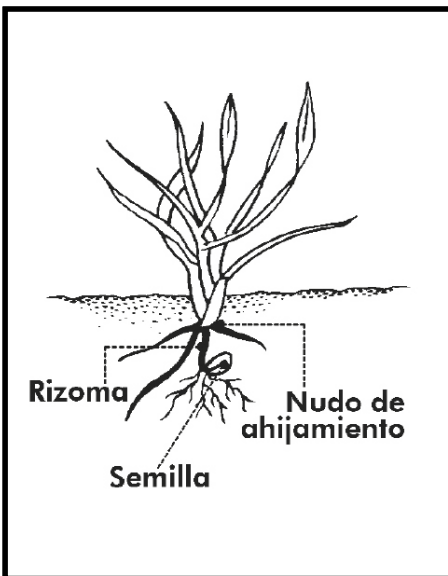

Deeper Planting: from 5 to 6 cm

Fine stem, rhizome exposed to frostbite.

Late and weak tillering, 1 or zero shoots and only a few blades, 3-4 aprox.

Medium quality roots of approximately 3 cm in width and 5 cm in depth.

More grains per sowing square metre are required to obtain the same number of ears as in the previous case.

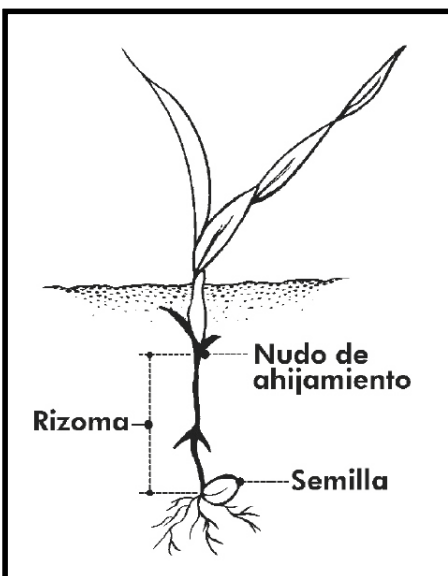

Very deep planting: from 8 to 10 cm

Very fine stem. No tillering and only one blade.

Seed runs out of supplies by growing a long rhizome which frostbite can easily cut.

The plant takes weak roots, approximately 1 cm in width and 3 cm in depth.

Twice the number of grains per sowing metre are required to obtain the same number of ears as in the first case.

WARNING



IN VERY COLD PLACES, REPEATED FROSTBITE CAN HAVE A HONEYCOMB EFFECT ON THE GROUND'S MOST SUPERFICIAL LAYER. IN THIS CASE THE PLANT'S VERY FIRST ROOTS CAN LOOSEN AND THE PLANT WILL DIE. SLIGHTLY DEEPER PLANTING IS RECOMMENDED AND IF POSSIBLE, THE USE OF ROLLERS TO COMPACT THE EARTH TO BETTER PROTECT THE SEEDS.



IN ALL SOLÀ SEED DRILLS, THE RIGHT SIDE WHEEL ACTIVATES THE SEED DISTRIBUTOR'S MECHANICAL TRANSMISSION. CONSEQUENTLY, SHARP CURVES SHOULD BE PERFORMED TOWARDS THE LEFT SIDE, SINCE USING THE GROUND WHEEL DRIVE WOULD CAUSE A LESSER SEED DISTRIBUTION.



WHEN STARTING THE MACHINE, FURROWS WILL NOT CONTAIN ANY SEEDS FOR A METRE. WHEN STOPPING THE MACHINE, SEEDS WHICH WERE PREVIOUSLY INSIDE THE SEED HOSES, SLIDE FROM THE MACHINE AND END UP PILED ON THE GROUND. TAKE THIS INTO ACCOUNT WHEN STOPPING AND STARTING THE MACHINE IN ORDER TO ACHIEVE MORE ACCURACY.



ALWAYS WORK AT A UNIFORM SPEED AS SUDDEN ACCELERATING AND SLOWING DOWN WILL CAUSE AN IRREGULAR SEED DISTRIBUTION.

4. STARTING

4.1 COUPLING THE SEED DRILL

Seed drill **ARES-2713** is supplied with a three-point linkage of category 3.



MAKE SURE THAT NO PERSON OR OBJECT IS EVER BETWEEN THE SEED DRILL AND THE TRACTOR WHEN COUPLING BOTH MACHINES.



TO COUPLE THE SEED DRILL AND THE TRACTOR, FOLLOW THESE STEPS:

Place the fast-locking balls in the two lower bolts.

Next, couple the fertilizer using the three-point linkage.

Once the seed drill is coupled with the tractor, **THE PTO SHAFT SHOULD BE ADAPTED:**

- 1- Dismount and insert one end into the tractor's universal joint shaft and the other end into the seed drill.
Look for the minimal movement length "L" by raising and lowering the hydraulic lift.
- 2- Cut the spare plastic and metal into parts of the same length and remount the PTO shaft.
- 3- Operate the hydraulic lift and check that the PTO shaft's movement is correct.
- 4- Secure the PTO shaft using the chain.

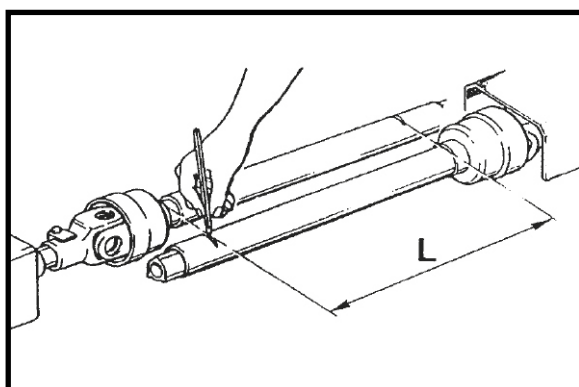
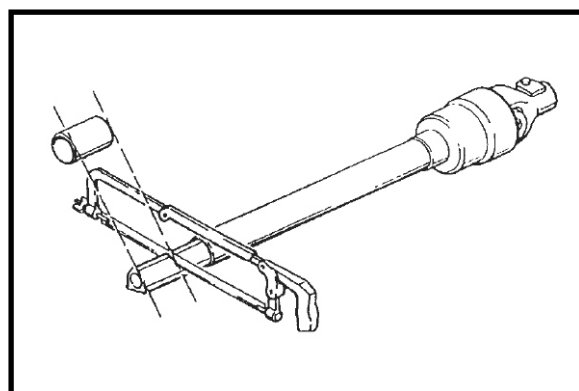

WHEN OPERATING THE PTO SHAFT CHECK THAT THE ENGINE IS OFF. ALWAYS WORK WITH THE PTO SHAFT PROTECTED AND IN GOOD CONDITION. PREVENT THE PTO SHAFT'S TUBE FROM TURNING BY SECURING IT WITH THE CHAIN PROVIDED.



WHEN LOWERING THE SEED DRILL TO THE GROUND, UNPLUG THE TRACTOR'S UNIVERSAL JOINT SHAFT SO THAT THE PTO SHAFT DOES NOT HAVE AN EXCESSIVE INCLINATION (MAX. 35°).



WHEN HOLDING THE TRACTOR UNIVERSAL JOINT SHAFT'S CLUTCH IN, PERFORM IT GENTLY. STARTING SUDDENLY COULD SERIOUSLY DAMAGE THE SEED DRILL.

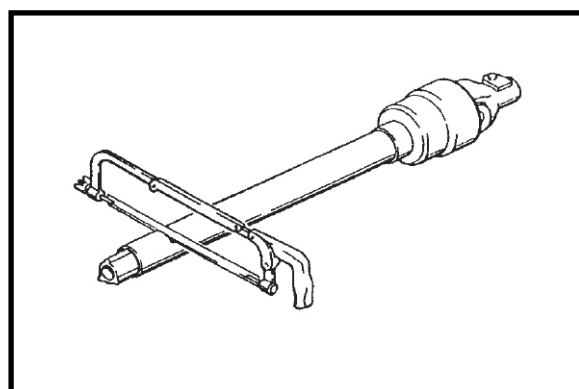

4.2 HYDRAULIC CONNECTIONS

To use the machine's hydraulic connections you will need:

WHEN FOLDING AND UNFOLDING THE MACHINE (1):

- a double-acting connection.

WHEN FOLDING AND UNFOLDING THE TRACK MARKERS (2):

- a double-acting connection.

If the machine has **HYDRAULIC FAN:**

- an extra single-acting (connection) and a free return line.

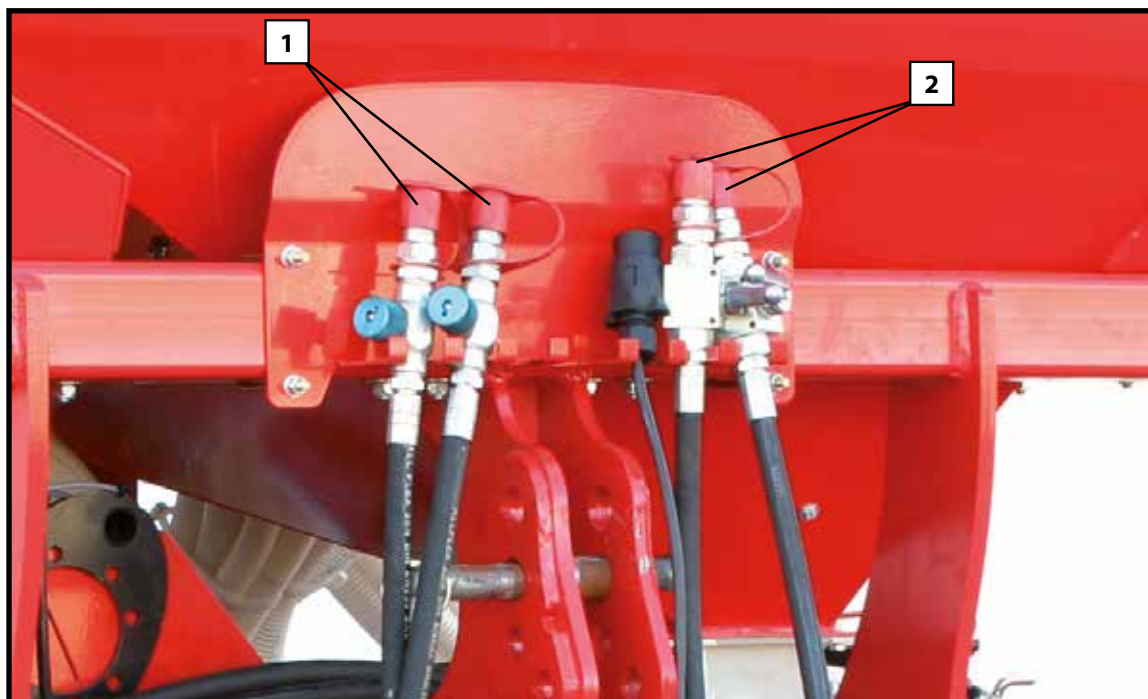

FOR THE FREE RETURN LINE CONNECTION USE THE PLUG-ADAPTER PROVIDED.



4.3 HYDRAULIC SYSTEM

FLOW REGULATORS

To smoothly hydraulically fold and unfold the seed drill, there are two flow regulators that perform both actions respectively. They should be adjusted depending on the hydraulic flow supplied by the tractor.

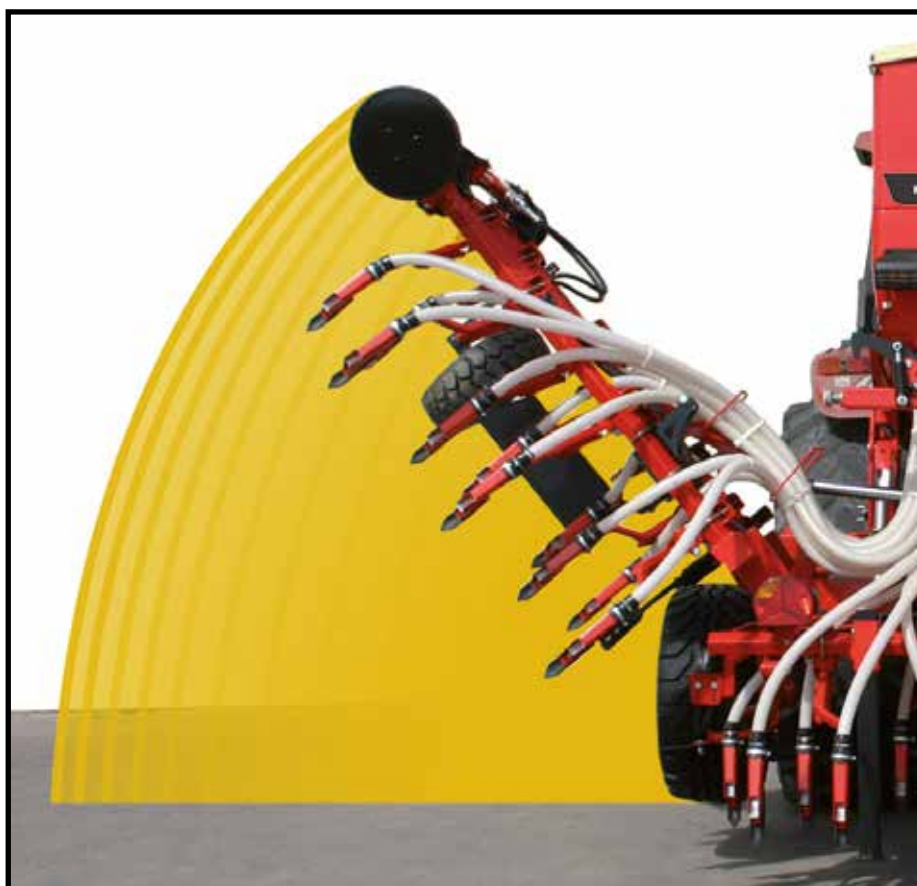

NEVER STAND UNDER THE MACHINE'S EXTENSION ARMS OR IN THEIR SWIVEL AREA.

Starting with an almost completely closed flow regulator is recommended to prevent folding too fast, which could damage the seed drill.



This is the POSITION OF THE TAPS of the hydraulic system to fold and unfold the folding parts:



This is the position of the taps of the hydraulic system to OPERATE the worm screw .



4.4 TRANSPORT POSITION

To set up the transport position, follow these steps:

- 1-** Fold the TRACK MARKERS.
- 2-** Raise the machine until the TINE COULTERS are detached from the ground.
- 3-** Fold the INTEGRATED CULTIVATOR (optional equipment) and put the 2 security bolts that secure the folding parts.
- 4-** Fold the 2 FOLDING PARTS of the machine and put the 2 security bolts that secure the folding parts. This will prevent the folding parts from falling during transit.
- 5-** Check that the LADDER to gain access to the hopper and the hopper's folding cover are both folded and secured (see section 5.5).



Check that the SIGNAL LAMPS are working properly.



AFTER COUPLING THE SEED DRILL TO THE TRACTOR, CHECK THAT THE SAFETY TRIGGERS ARE CORRECTLY IN TRANSPORT POSITION.



PREVENT THE MOBILE PARTS FROM MOVING.

4.5 LOADING THE SEED DRILL MANUALLY

For access to the hopper, the access ladder should be unfolded.

Pull the trigger (1) to free the folding flight to the ground.

To fold, return the folding flight until the safety trigger is secured.

Remove the tension element (2) of the hopper's folding cover and fold it over to the left using the handle (3).

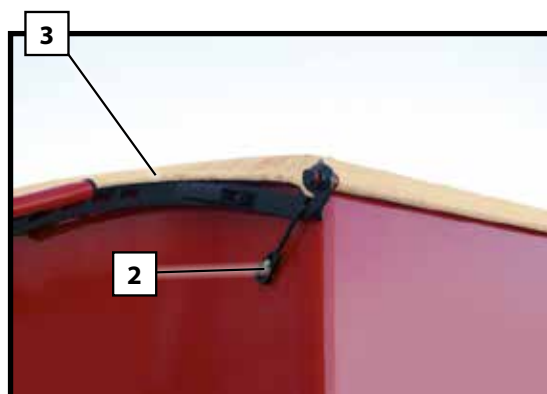

4.6 LOADING THE SEED DRILL USING A WORM SCREW

The machine is provided with a connection to load the hopper using a worm screw.

Set the position of the taps as shown in the picture.



4.7 THE BUILT-IN SUPPORTING LEGS

The machine has two built-in supporting legs to prevent it from falling back during the uncoupling manoeuvre.

Before starting work with the machine, RAISE THESE SUPPORTS.



WORKING WHILE THE SUPPORTS ARE IN PLACE MAY CAUSE DAMAGES TO THE MACHINE.



BEFORE RAISING THE SUPPORTING LEGS, THE MACHINE MUST BE RAISED TO MAKE THE OPERATION EASIER AND PREVENT THE MACHINE FROM FALLING BACKWARDS.



- 1-** Remove the safety ring (1).
- 2-** Remove the securing bolt (2).
- 3-** Shift the support upwards.
- 4-** Align the 2 holes and place the securing bolt (2).
- 5-** Place the safety ring again. (1).

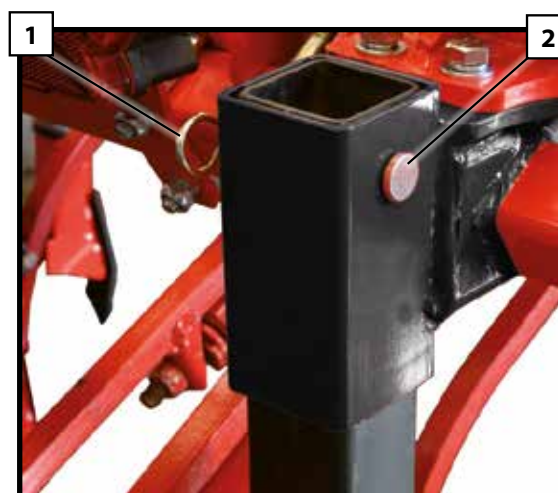

5. DOSAGE

There are two ways of dosing:

- for **REGULAR SEEDS**.
- for **FINE SEEDS** with minimum flow rate.

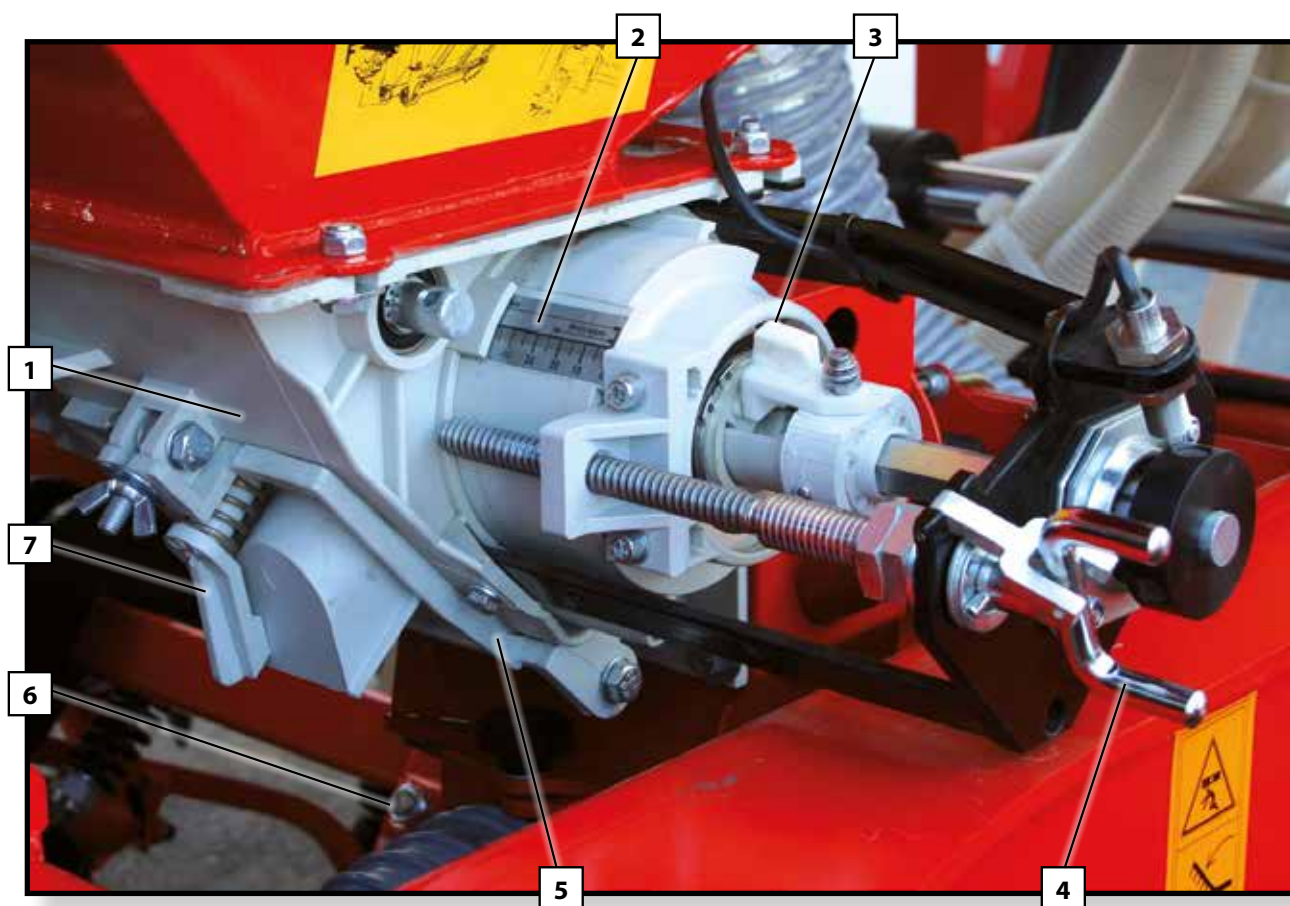

1- Seed distributor.

2- Dosing adjusting scale.

3- Bolt:

N = regular seed

F = fine or small seed

4- Spindle.

5- Trap-door to empty the hopper and the seed distributor.

6- Venturi injector sluice.

7- Quick emptying trap-door.

8*- Clip pin of the air outlet to fan *.

N = regular seed

F = fine or small seed

* (see next page)



WHEN CHANGING THE BOLT'S POSITION (3) IT IS ESSENTIAL THAT THE SPINDLE (4) CAN TURN FREELY AND THE HOPPER IS EMPTY.

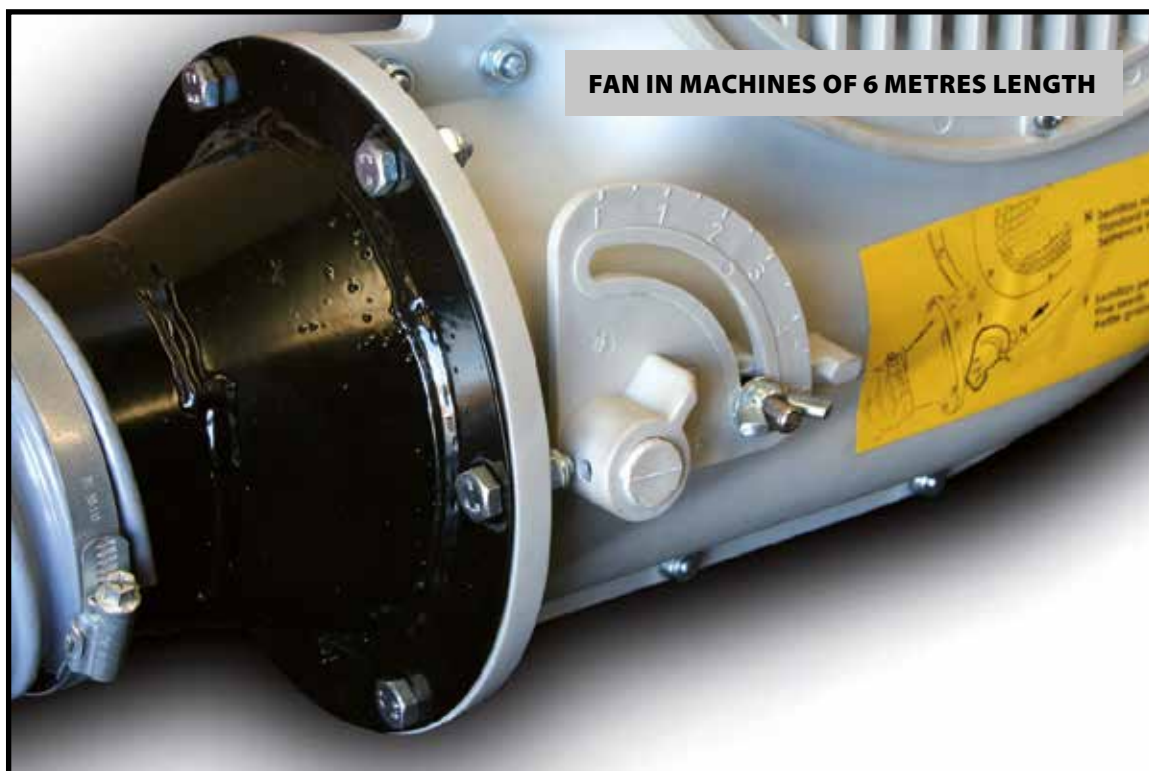
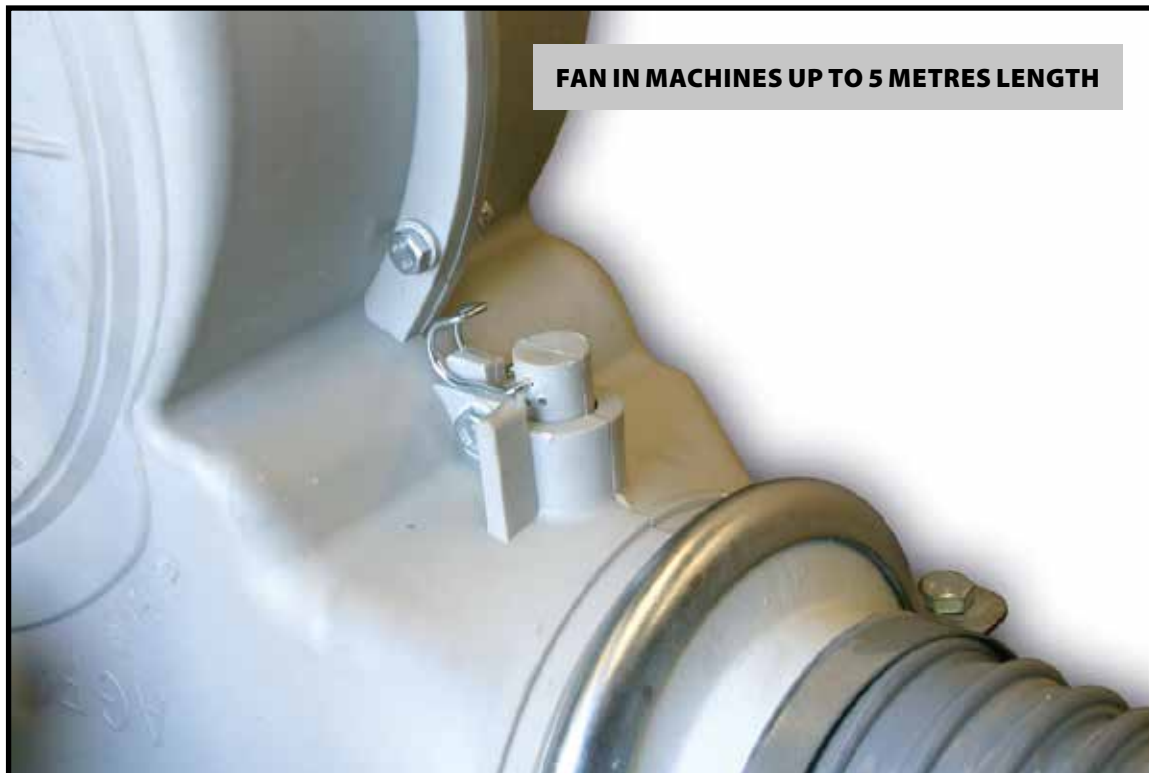

5.1 REGULAR SEEDS (position N)

When sowing using REGULAR SEEDS, proceed as following:

- 1- Remove the safety fork (9).
- 2- Keep the bolt (3) in the position as indicated in the figure.
- 3- Turn the spindle (4) to adjust dosing.

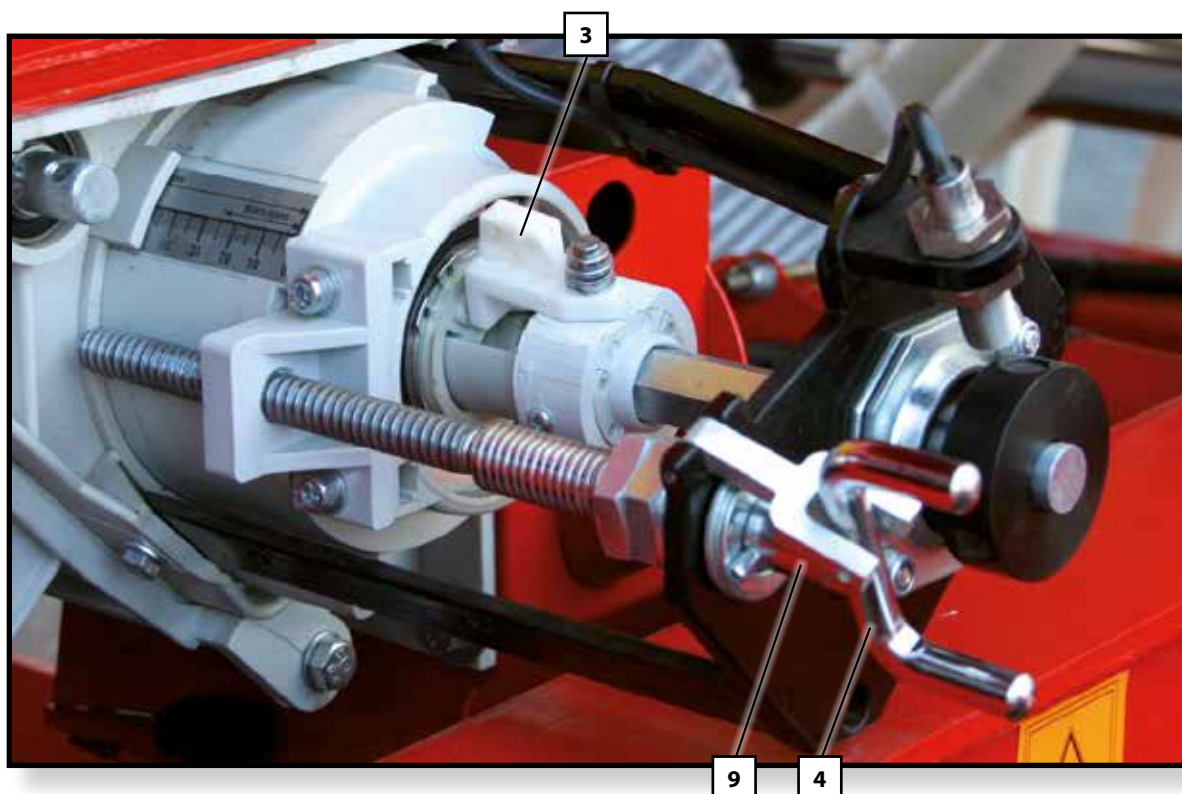

- 4- Place the clip pin of the air outlet to fan (8) at position N.

FAN IN MACHINES UP TO 5 METRES LENGTH.



FAN IN MACHINES OF 6 METRES LENGTH.



- 5-** Pinion gear n°10 must be fit into pinion gear n°11, as shown in figure.

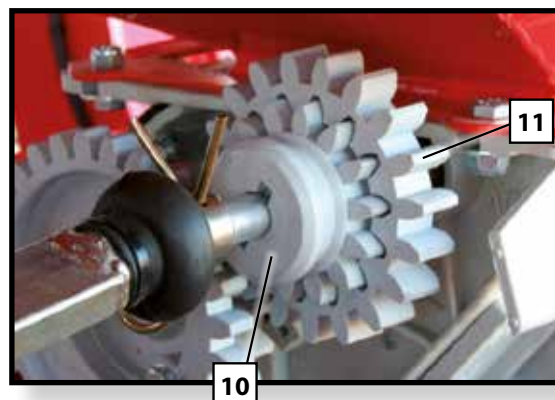

5.2 FINE SEEDS (microdosing – Position F)

When sowing using FINE SEEDS, proceed as following:

- 1-** Remove the safety fork (9).
- 2-** Turn the spindle (4) to position 0 on the scale (2).
- 3-** Turn the bolt (3) until it is inserted into axle slot, like to the picture.

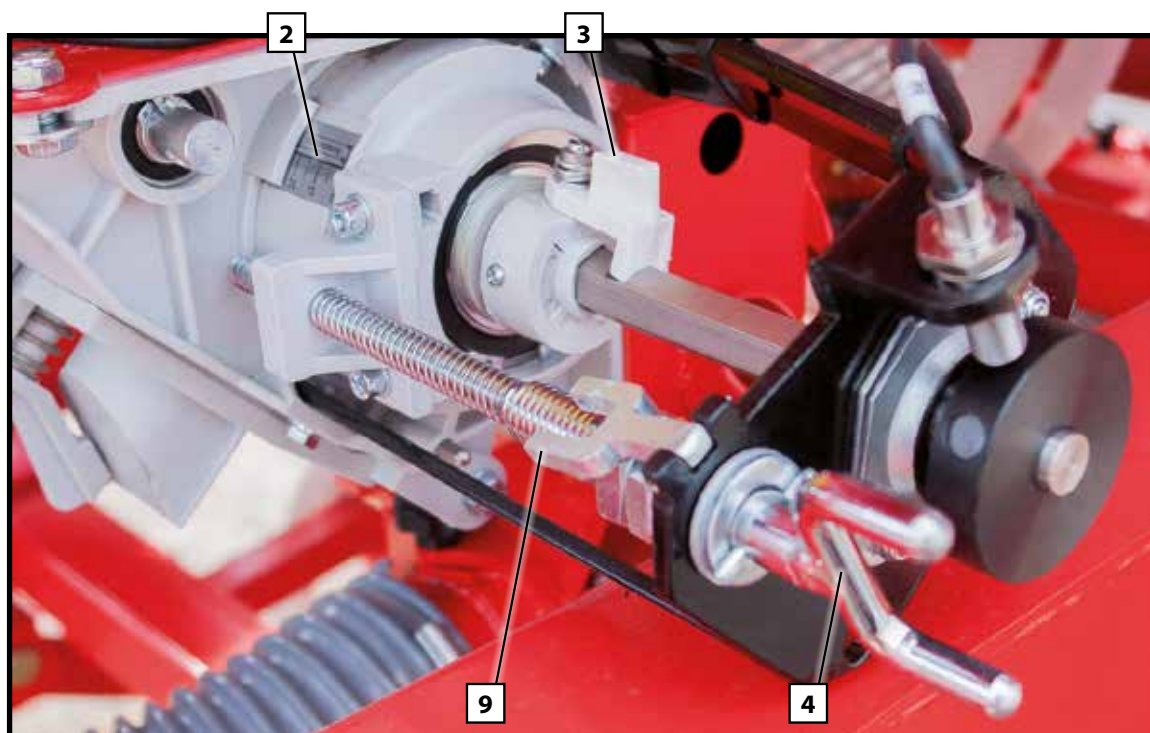

4- Place the clip pin of the air outlet to fan (8) at **position F** (fine seed).

TURBINA MÁQUINAS HASTA 5 METROS.

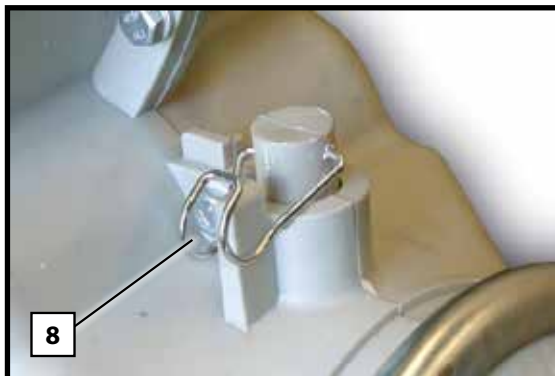

TURBINA MÁQUINAS HASTA 6 METROS.



5- Turn the spindle (4) to adjust dosing between 0 and 25.

6- Pull the pinion gear nº10 until it **is released** from the pinion gear nº11 and fit it into pinion gear nº12.

7- Once the seed distributor is set in position F (microdosing), the **ELECTRONICAL CONTROLLER** needs to be configured (see section working in micro mode).

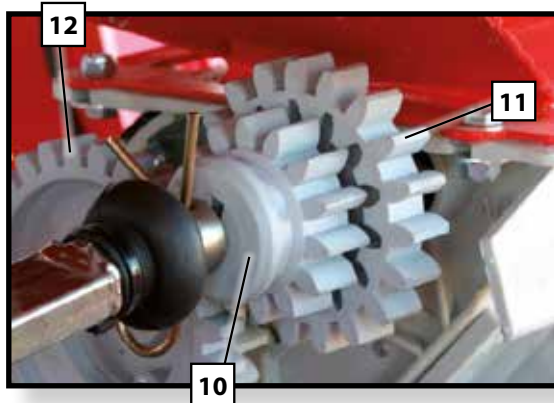

THE AIM OF MICRODOSING IS TO BETTER DISTRIBUTE BOTH FINE AND REGULAR SEEDS IN SMALL NUMBERS.



THE CORRECT VALUE FOR USING MICRODOSING F-SYSTEM IN FINE SEEDS CAN BE FOUND IN THE DOSING TABLES (SEE SECTION DOSAGE TABLES).



CHECK THE CLEANING BRUSH IS IN GOOD CONDITION BEFORE BEGINING TO SOW FINE SEEDS.



WHEN MICRODOSING FINE SEEDS, DO NOT EXCEED NUMBER 25 IN ADJUSTING SCALE (2).

5.3 PREVIOUS FLOW TEST



IT IS ESSENTIAL THAT THE MACHINE, THE TRACTOR AND THE UNIVERSAL JOINT SHAFT ARE ALL SWITCHED OFF.

To perform the test, follow these instructions:

1- FILL THE HOPPER with seeds.



2- COUPLE the machine to the tractor in a **SLIGHTLY ELEVATED POSITION** (wheels should not be in contact with the ground).



3- Open blockers venturi injector cap (1).

Rotate and shift lever to the **"NO"** position (A).

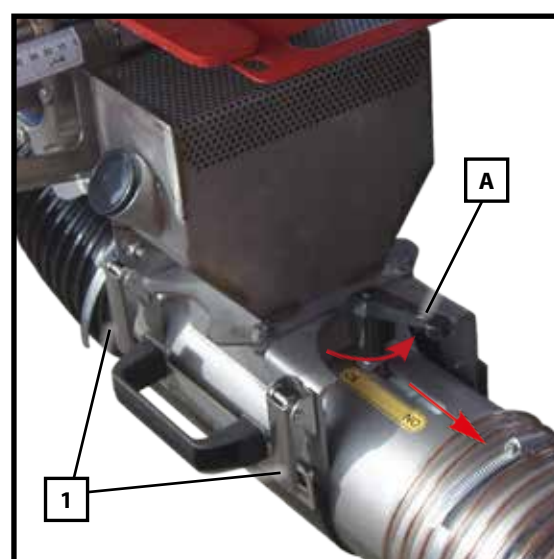

4- Place the provided sack (2) or a container under the exit of the venturi injector sluice.

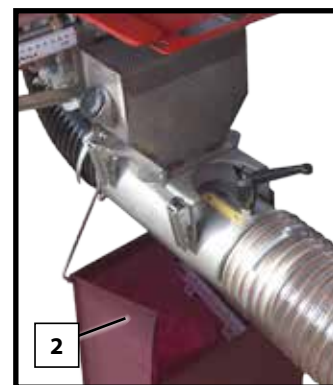

5- Next, place the crank in the right wheel of the seed drill.

Turn it clockwise as many times as indicated below depending of the type of machine.



TYPE OF MACHINE	WHEEL 10.0/75-15,3 (turns)	WHEEL 340 / 55-16 (turns)
400 / 32	27,4	26,5
450 / 35	24,4	23,5
500 / 40	22	21,2
600 / 48	18,3	17,7

6- Accurately weigh the collected seeds.

7- At a selected opening, you can obtain the kilograms per hectare distributed by the machine, by MULTIPLYING the weight by 40.



DO NOT TURN THE WHEEL WITH YOUR HANDS AS THE MUD SCRAPER CAN CAUSE INJURIES.



YOU MUST TURN THE WHEEL UNIFORMLY USING THE CRANK AT APPROXIMATELY ONE REVOLUTION PER SECOND.



THE NUMBER OF WHEEL TURNS TO BE PERFORMED DEPENDS ON THE LAND'S CHARACTERISTICS, TYRE MANUFACTURER AND TYRE PRESSURE. THEREFORE IT IS HIGHLY RECOMMENDED TO PERFORM A FIELD TEST AS DESCRIBED IN SECTION **6.4 - TEST TO DETERMINE THE NUMBER OF WHEEL TURNS.**



WHEN YOU END THE TEST, CLOSE THE COVER OF VENTURI INJECTOR, MOVE HANDLE IN POSITION "OK" AND LOCK IT.



IF SEEDS SHOW EXCESS TREATMENT POWDER, FLOW CAN BE REDUCED, CONSEQUENTLY A SECOND CONTROL IS RECOMMENDED AFTER SOWING APPROXIMATELY THREE HOPPERS.



5.4 COMPLEMENTARY CHECKING TESTS

5.4.1 Test to determine the number of wheel turns.



IF DIFFERENCES EXIST BETWEEN THE TEST AND THE ACTUAL DOSE DISTRIBUTION (DUE TO A VERY UNEVEN OR LIGHT SOIL, LOW PRESSURISED TYRES, ETC.), AN EXPERIMENTAL TEST CAN BE PERFORMED.

- 1- First of all, the distance (in metres) as shown in the table below should be marked on the field's ground using a tape measure.

WORKING WIDTH / ROWS	METRES TO COVER
400 / 32	62,5
450 / 35	55,6
500 / 40	50,0
600 / 48	41,7



- 2- By means of a mark made previously on the tyre, count the number of turns performed in the covered distance.

A good place whereby which to count could be the wheel's mud scraper.

- 3- Next, the seed drill in working position should cover that distance.



By following these steps we can obtain the actual number of turns performed in the seed dosing test. By performing the test using this obtained number of turns, we know the actual kilograms per hectare that will be distributed by the machine.

5.4.2 SEED DOSING ADJUSTMENTS

When using high quality certified seeds it is not enough to know the weight in kilograms distributed by the machine, as the final result of the harvest will depend on the number of plants which eventually ripen.

Every plant requires a certain amount of land from which nutrients will be absorbed. Therefore, both a low or an excessive plant density can be detrimental. To determine how many kilograms per hectare are to be sown, you should know the number of plants per square metre that are going to be planted.

As a guidance, the recommended number of plants per square metre when sowing wheat or barley in unirrigated land can be found in following table:

AUTUMN	SPRING
Premature sowing, 200 plants per m ²	Premature sowing, 310 plants per m ²
Late sowing: 265 plants per m ²	Late sowing: 445 plants per m ²

Please note that in spring there is less tillering so more seeds should be sown.



MAQUINARIA AGRÍCOLA SOLÀ, S.L., RECOMMENDS THAT THE FARMER SEEKS PROFESSIONAL ADVICE ABOUT THIS SUBJECT FROM A TECHNICAL SOWING CENTRE.

SEED DOSING SHOULD BE ADJUSTED TO EACH TERRAIN, DEPENDING ON THE: TEXTURE, FERTILIZING LEVEL, PLUVIOMETER RESULTS AND SOWING SEASON, GRAIN QUALITY, GERMINATING AND TILLERING POWER, ETC.

It should be taken into account that a seed's germinating power is variable and dependant on multiple factors. It can be experimentally calculated to be between 70% and 80%, which is practically equivalent to multiplying the number of grains to be sown by 1,43 or 1,25 respectively.

DOSAGE

Next, we describe a practical method to determine the number of kilos per hectare to be distributed once we know how many plants per square metre we want to obtain.

- 1- Insert the "seed counter" into the seed sack to fill it.
- 2- When taking the "seed counter" out, wipe the seed counter with your hand to make sure that there is only one grain per slot (100 grains in total).

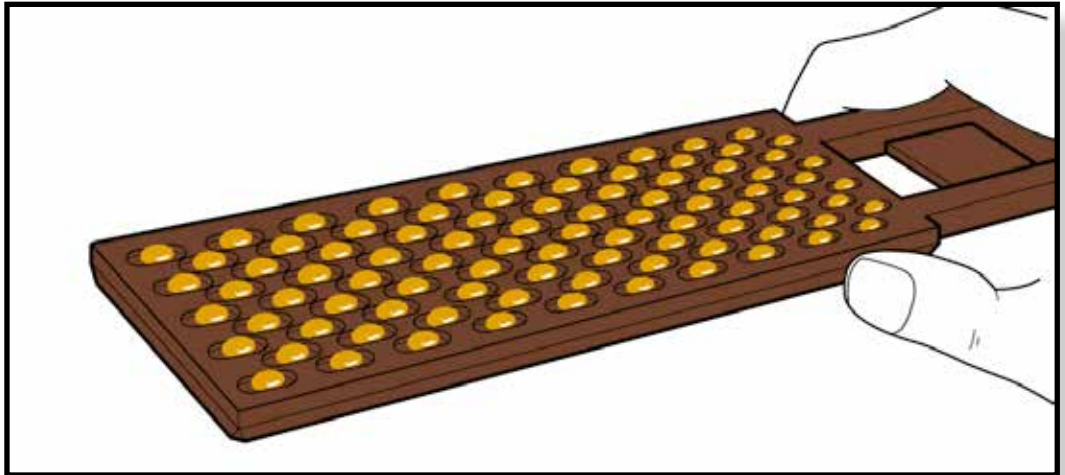

- 3- Do the same 10 more times to obtain 1000 grains.
- 4- Weigh these 1000 grains with the precision scales.

We call the result the OPERATIVE WEIGHT (gr.).

Once we know how many seeds per square metre we are going to sow, we should adjust the following kilograms per hectare in the dosing control:

$$\text{kilograms per hectare} = (\text{grains per m}^2 \times \text{OPERATIVE WEIGHT}) / 100$$

6- ADJUSTING SEED PLANTING DEPTH



SEED DRILL SHOULD ALWAYS WORK HORIZONTALLY, WITH BOTH THE REAR AND FRONTAL TINE COULTERS EQUALLY PENETRATING THE LAND.



VERY IMPORTANT: THE TRACTOR'S CONTROLLER THAT MOVES THE FOLDING PARTS' CYLINDER MUST BE IN FLOTATION MODE, TO BETTER ADAPT TO THE GROUND.

6.1 ADJUSTING RATCHETS AND SPINDLES

There are two ratchets in the machine's central body and two spindles in the side wheels. All of them have an adjusting scale to indicate their position.



THEIR ADJUSTMENT POSITIONS IN THE RESPECTIVE SCALES SHOULD BE THE SAME.

After adjustments, the control lever of the ratchet should be pulled back towards the inner part of the machine.



WHEN SOWING ON TILLED OR NON-COMPACT GROUND, TAKE THE PRECAUTION OF SELECTING ONE OR TWO POINTS LOWER IN THE ADJUSTING SCALE ON THE SIDE WHEELS IN ORDER TO AVOID SINKING INTO THE GROUND.

ADJUSTING SEED PLANTING DEPTH

To adjust the side wheels, use the crank provided.

Steps to follow for the regulation of equipment:

- 1- To adjust the side wheels, use the crank provided.
- 2- Unlock using the securing knob (2).
- 3- Turn the crank right or left as required (1).
- 4- Use the scale (3) to reach the suitable height.



Once the suitable height has been reached, secure it using the handle.



6.2 INCLINATION OF THE FOLDING PARTS

At the connection point between the folding parts and the central chassis, there are adjustable stops (two each side) which allow the inclination angle of the folding parts to change.

- 1- Loosen the 2 securing nuts.
- 2- Remove the 2 screws.
- 3- Place the stop in the desired position.
- 4- Insert the 2 screws and tighten them using the 2 securing nuts.



DURING NORMAL SOWING CONDITIONS, THE FOLDING PARTS SHOULD BE SLIGHTLY LOWER THAN USUAL TO ADAPT TO TERRAIN IRREGULARITIES. IN VERY TILLED OR LOOSE LAND, AS WELL AS IN SOILS WITH HIGH HUMIDITY, THE FOLDING PARTS SHOULD BE LEVELLED TO STAY HORIZONTAL.

6.3 EQUIPMENTS WITH TINE COULTERS

Fixed tine coulters:

These tine coulters have a non-adjustable depth, but their pressure can be adjusted by using a nut placed in the lower part of the spring (1). Sowing depth will be determined by the adjustable central ratchets.

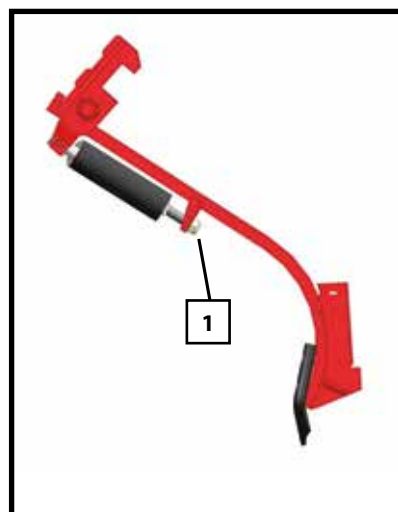

Adjustable tine coulters:

These tine coulters are aligned with both the tractor's and the seed drill's wheels. They are adjustable levels of depth which allow the tine coulters to be lowered:

- 1- Turn the nut with a wrench to lose the screw (2).
- 2- Turn the screw stop to control depth (2).
- 3- Tighten the nut to secure the position (2).



6.4 HARROW

Some adjustments can be performed on the harrow so that it can adapt to all types of ground:

HEIGHT ADJUSTMENT, by operating the lower nut (1).

PRESSURE ADJUSTMENT, by using the spindle's upper nut (2).

INCLINATION OF THE TINES, by operating the slide (3 and 4) which holds the tines' chassis.

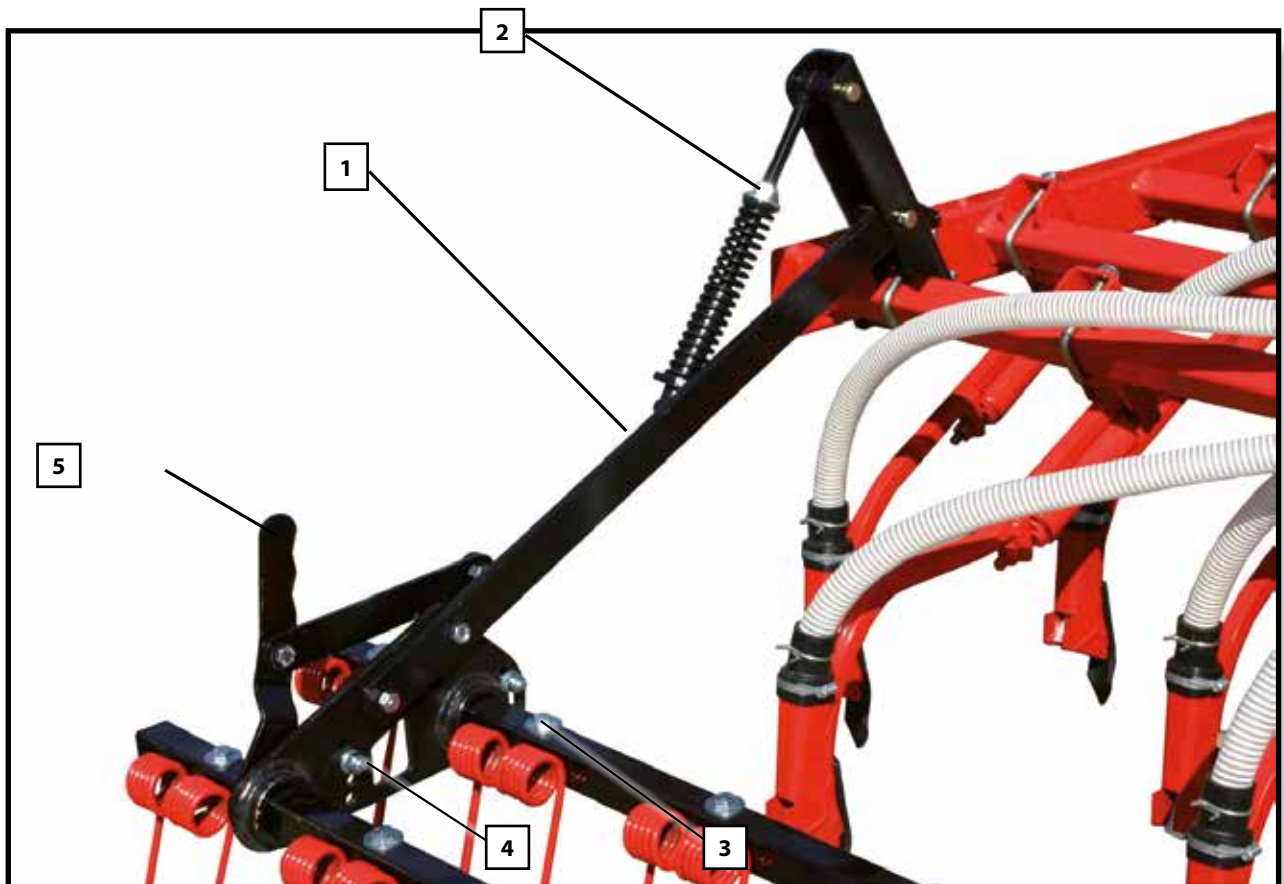

To adjust harrow's inclination, follow these steps:

- 1- Loosen the nut (3).
- 2- Take out both the screw and the nut (4).
- 3- Pull back the bar (5) and place both the screw and the nut in the hole that is in the middle of the bar (4).

6.5 HYDRAULIC TRACK MARKERS

Track discs can be orientated to achieve the correct penetration angle and their supporters are extensible in order to be correctly adjusted.

LENGTH (horizontal spacing between disk and external element).

ORIENTATION (penetration angle).



HIGH PRESSURE OIL MAY ESCAPE, PASS THROUGH THE SKIN AND INGRESS INTO THE BODY, CAUSING SERIOUS INJURIES. KEEP HYDRAULIC HOSE LINES IN GOOD CONDITION.



NEVER STAND UNDER THE TRACK DISCS OR WITHIN THEIR OPERATIONAL AREA.



IT IS ESSENTIAL TO FOLD THE TRACK MARKERS BEFORE FOLDING THE MACHINE FOR TRANSIT.

6.5.1 Adjusting track marker's LENGTH

To calculate the horizontal spacing between track discs and the last lateral tine coulters, use following formula:

$$B = \frac{A \times (\text{number of tine coulters} + 1) - C}{2}$$

- A**= distance between tine coulters
- B**= horizontal distance between track disc and the the last lateral tine coulters.
- C**= track width of the tractor.



PERFORM THE CALCULATION USING MEASUREMENTS IN CENTIMETRES.

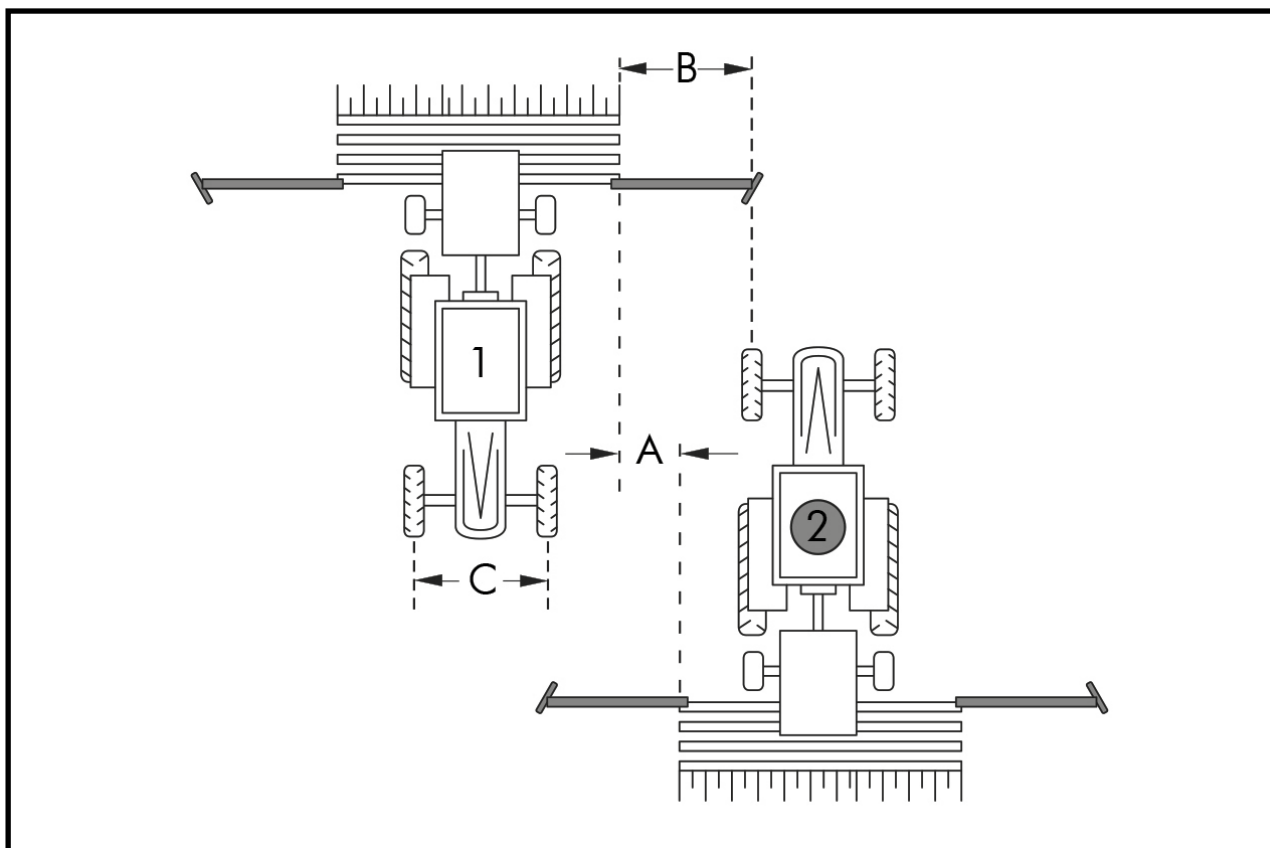

To adjust the distance of the track disc, proceed as following:

- 1- Loosen the 2 nuts (1).
- 2- Place track disc at the distance B previously calculated.



B= DISTANCE BETWEEN THE TRACK DISC AND THE LAST LATERAL TINE COULTER.

- 3- Tight the 2 nuts (1) after finishing these operations.

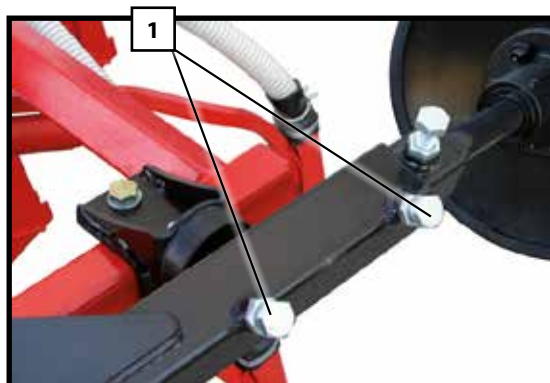

6.5.2 Adjusting track marker's INCLINATION

To adjust the orientation of the track discs, proceed as following:

- 1- Loosen the nut (2)
- 2- Adjust track disc's inclination so the disc has the desirable impact on the ground.
- 3- Tight the nut (2) after finishing these operations.

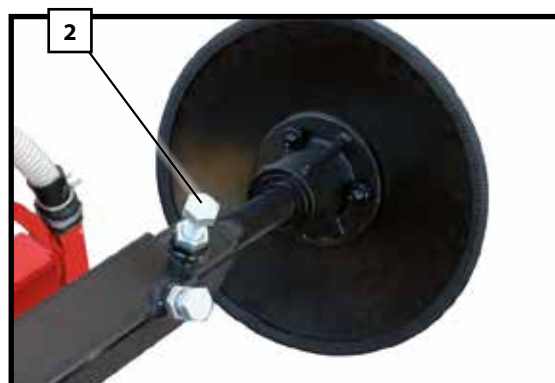

IT IS NOT RECOMMENDED TO INCLINE THE TRACK DISCS TOO MUCH THUS PREVENTING SERIOUS DAMAGE TO THE MACHINE.

7- TYPES OF DISTRIBUTION

7.1 SEED DISTRIBUTION BY MECHANICAL FAN



TO ENSURE THAT SEEDS ARE SUPPLIED TO THE TINE COULTERS' SOWING SHOES, IT IS ESSENTIAL THAT THE FAN SPEED IS BETWEEN 4200 AND 4500 RPM. FOR THIS PURPOSE, THE PTO SHAFT MUST BE PLUGGED INTO THE 1000 RPM VENT.



IF THE TURNING SPEED IS LOWER THEN SOME SEEDS ARE LIKELY TO REMAIN IN THE SEED HOSES.



BEFORE THE WHEEL CONTROLLING THE DISTRIBUTOR'S TRANSMISSION STARTS TURNING, PLEASE ENSURE THAT THE FAN'S TURNING SPEED IS BETWEEN 4200 AND 4500. WHEN RAISING THE MACHINE, NEVER DECREASE THE FAN'S TURNING SPEED UNTIL THE WHEEL IS DETACHED FROM THE GROUND.



PLEASE NOTE THAT IF YOU WORK WITH THE MACHINE WHILE THE FAN IS OFF, SEEDS WILL BLOCK THE COLLECTING PIPE OF THE VENTURI INJECTOR SLUICE. IN CASE THIS HAPPENS, THE COLLECTOR SHOULD BE TAKEN OUT AND EMPTIED BEFORE USING THE SEED DRILL AGAIN.



IF THE FAN'S TURNING SPEED IS ABOVE OR BELOW 4200 AND 4500 RPM, THEN TURNING THE WHEEL THAT CONTROLS THE DISTRIBUTOR'S TRANSMISSION CAN CAUSE A BLOCKAGE INSIDE THE SEED HOSES.

7.2 SEED DISTRIBUTION BY HYDRAULIC FAN

MACHINE TYPE	HYDRAULIC MOTOR		OIL SUPPLY		
	ABSORBING CAPACITY (cm ³)	SPEED (rpm)	MINIMUM OUPUT PRESSURE (bares)	MAXIMUM RETURN PRESSURE (bares)	OIL FLOW (L/min)
400 / 450	8	4.200	130	1,5	36
500 / 600	8	4.500	160	1,5	40

CONNECTIONS

Connect the fan's small hydraulic hose line to a pressurised tractor control unit. The fan's 1/2" hydraulic hose line should be connected to a depressurised return tractor control unit.



IN THE RETURN LINE THE PRESSURE MUST BE A MAXIMUM OF 1,5 BAR. A HIGHER PRESSURE CAN CAUSE DAMAGE TO THE TRACTOR'S MOTOR.

ADJUSTMENT

The fan's rpm is adjusted by regulating the tractor control unit.

The fan's turning speed must be adjusted to 4200 rpm or to 4500 rpm as shown in table above.



IF OIL IS OVERHEATED DUE TO AN EXCESSIVE FLOW OR DUE TO LOW OIL SUPPLY, THEN AN ADDITIONAL OIL TANK WILL BE REQUIRED.



IF THE FLOW OF THE TRACTOR'S HYDRAULIC PUMP IS NOT HIGH ENOUGH IT WILL NOT BE ABLE TO POWER THE FAN'S MOTOR OR ACTIVATE THE OTHER ELEMENTS REQUIRED. IN THIS CASE AUXILIARY EQUIPMENT CONSISTING OF A HYDRAULIC PUMP FITTED ON THE TRACTOR'S UNIVERSAL JOINT SHAFT THAT DRIVES THE FAN'S HYDRAULIC MOTOR AS WELL AS A REFRIGERATED OIL TANK WILL BE REQUIRED.

8- ELECTRONICAL CONTROLLER

8.1 FRONT PANEL DESCRIPTION

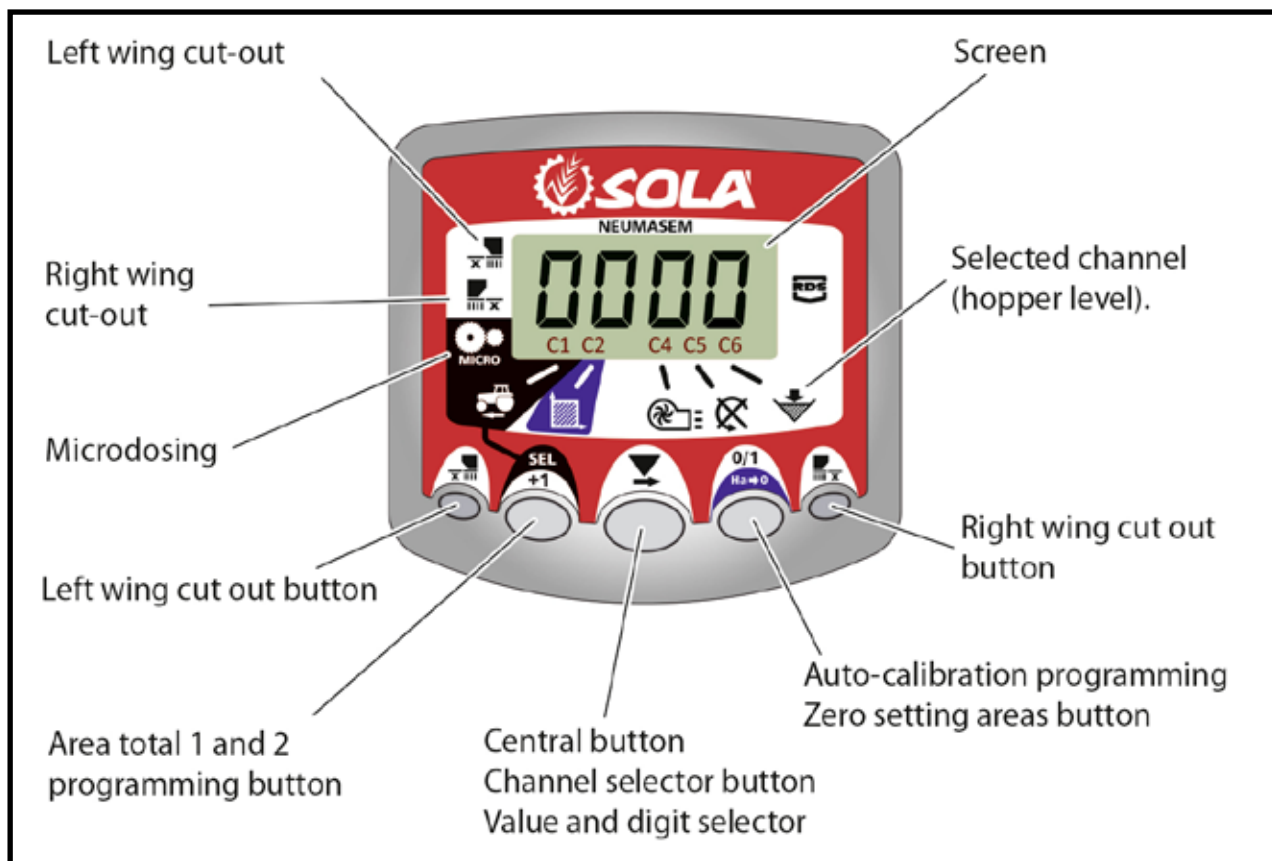

The monitor provided comes programmed especially for your model of seed drill. The user will only need to observe the displayed values and no extra programming is required.

The monitor shows 6 different channels or readings, as well as 3 different arrows showing the states.

C1 shows forward speed in m/sec.

C2 shows two different hectares (for example on partial and one total hectare).

C3 not in use.

C4 shows the fan's rpm.

C5 shows the turning speed of the distributor's axle's in rpm.

C6 shows if the hopper's seed level is too low.

By default the forward movement speed is displayed on the monitor. When some abnormal readings are shown, the screen will display “**Alarm**” intermitently, the alarm will sound and the corresponding malfunction channel will be activated. The alarm will not stop until the malfunction is fixed.

To display a desired reading, press the central button and scroll to the required channel. After 10 seconds, the reading will change back to C1 again.

8.2 FORWARD SPEED – C1



Select a channel by using the central button. The alarm is activated when the speed is under 2.6 km/h and can be turned off using programming mode 2.

Calibrating the speed sensor

Theoretical calibration is achieved by entering a calibration factor in programming mode 2, as indicated in the following table.

MODEL	4M	4.5M	5M	6M
CALIBRATION FACTOR (WHEEL 10.0/75-15,3)	1,752	1,518	1,402	1,215
CALIBRATION FACTOR (WHEEL 340 / 55-16)	1,815	1,573	1,452	1,259



Selecting speed channel (C1)

- 1- Press  to switch to mode 1. While holding the button, press the central button  to modify the digit.
- 2- Hold the central button for some seconds to modify the flickering digit.
- 3- When the buttons are released, the monitor will return to its normal state.



PLEASE NOTE: THE IMPULSE NUMBER AUTO CALIBRATION MODE IS MORE ACCURATE AND A FIELD TEST PERFORMANCE IS REQUIRED.

Auto-calibrating the speed sensor

- 1- Mark 100 metres.
- 2- Select channel 1 (speed).
- 3- Press  and hold it while pressing . The screen will display "Auto". Release it.
- 4- Cover the 100 marked metres. The monitor will count the sensor's impulses.
- 5- After finishing, press  again. By doing this, the monitor retains the impulse number in the memory.



8.3 TOTAL AREA / SEED DRILL WIDTH – C2

Two independent total areas can be marked.

Displaying the total area

- 1- Select channel 2.
- 2- Press  to display total areas 1 and 2 on the screen. First, "tot. 1" will be displayed and immediately afterwards the value in Ha will be shown.

Setting to zero the total areas

- 1- Select channel 2.
- 2- Press  to display.
- 3- Press and hold  for more than 5 seconds..

Programming the working width

- 1- Select channel 2 of the area.
- 2- Press and hold  for more than 5 seconds until the width value is displayed and, without releasing it, press the central button to modify the flickering digit.
- 3- Press and hold the flickering digit for more than 5 seconds to modify its value.
- 4- Release all buttons to return to the normal state.

Working in micro mode

When working with the distributor in the micro-dosing mode (for small hoppers and minimal doses), press and hold  button for more than 3 seconds until the arrow indicating the micro mode is displayed. In this situation, the monitor will keep the speed and actual real working area.

Press and hold  for more than 5 seconds until the indicating arrow disappears to resume normal position.

8.4 CONTROL PANEL WITH TRACK MARKER (OPTIONAL)

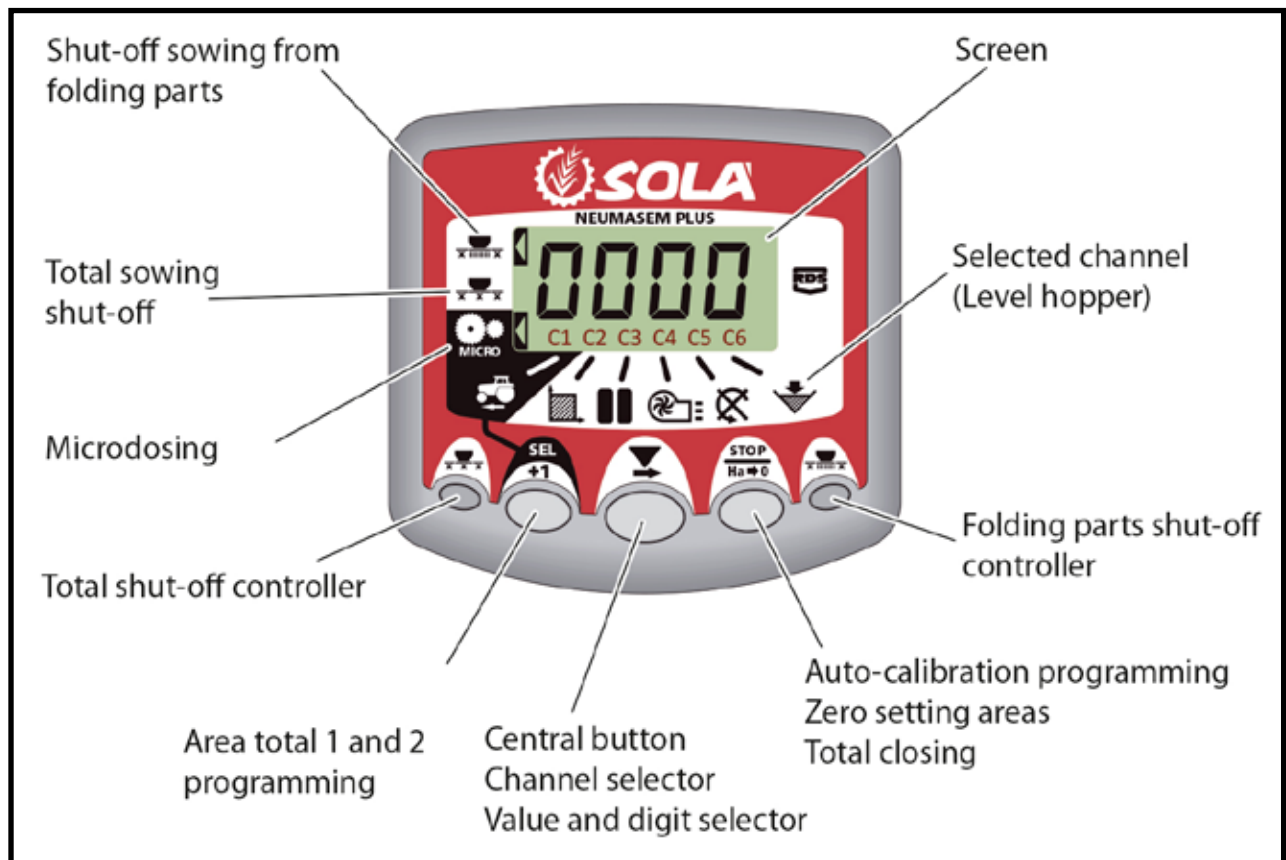

The monitor provided comes programmed especially for your model of seed drill. The user will only need to observe the displayed values and no extra programming is required.

The monitor shows 6 different channels or readings, as well as 3 different arrows showing the states.

C1 shows forward speed in m/sec.

C2 shows two different hectares (for example on partial and one total hectare).

C3 tramlining.

C4 shows the fan's rpm.

C5 shows the turning speed of the distributor's axle's in rpm.

C6 shows if the hopper's seed level is too low.

8.4.1 TRAMLINING - C3

The displays defaults to the  channels after 10 seconds (unless the Area Total was selected).

There are five systems of tramlining - symmetric, asymmetric left, asymmetric right, 10 bout and 18 bout. The tramline bout is programmable from 1 to 15 in symmetric, asymmetric left and asymmetric right sequences.

Selection of asymmetric tramlining is denoted by a decimal point on the display between the current bout number on the left and the tramline bout number on the right. Left or right asymmetric tramlining is selected in the programming mode.

Manually advance the bout number

Press  to advance the current bout number by 1.

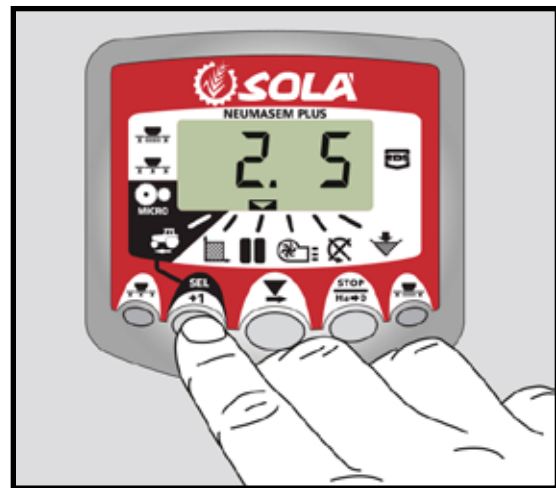

Hold the bout number

Press  to "hold" the current bout number when the drill goes out of work.

The display will flash '**STOP**'.

Press  again to resume the normal bout sequence.



Symmetric Tramlining Sequence

2+2 seed spouts are closed during the tramline bout.

The instrument will beep once the beginning of the tramline bout, and the display will continue flashing for the duration of the bout.

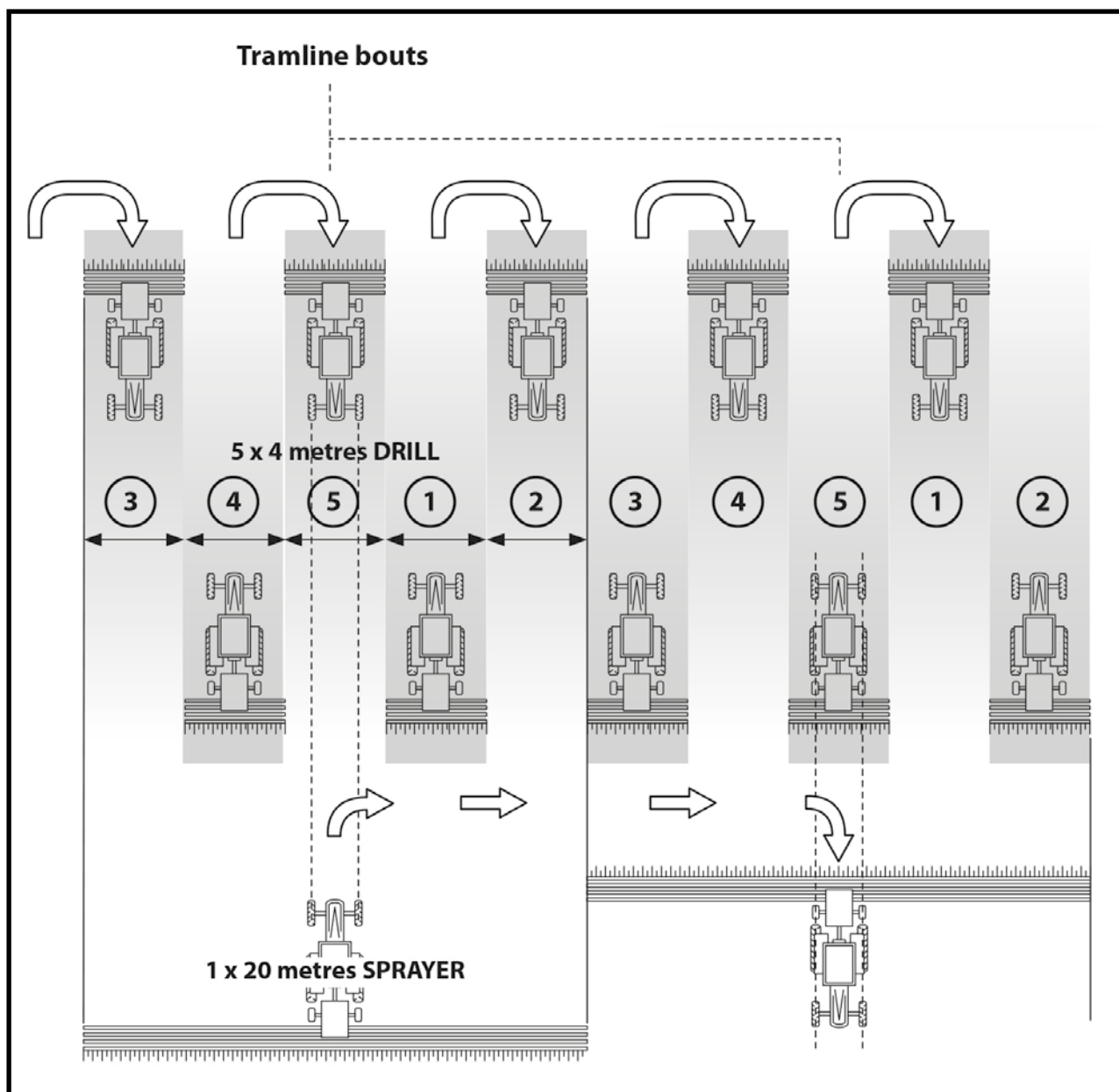

Asymmetric Left Tramlining Sequence

Two seed spouts are closed on the left hand side of the drill on the tramline bouts. The instrument will beep once the beginning of each tramline bout, and the display will continue flashing for the duration of the bout.

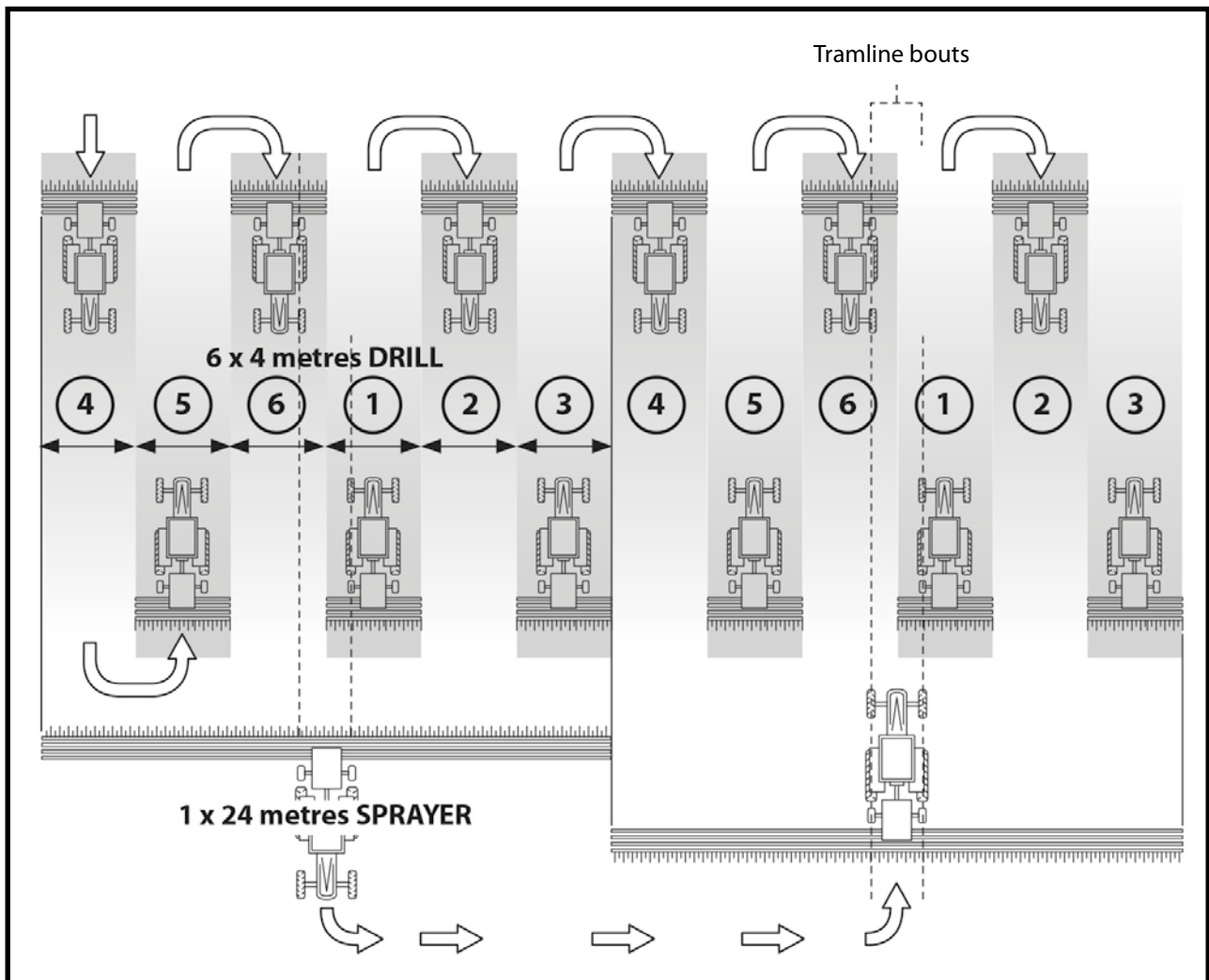

Asymmetric Right Tramlining Sequence

Two seed spouts are closed on the right hand side of the drill on the tramline bouts. The instrument will beep once the beginning of each tramline bout, and the display will continue flashing for the duration of the bout.

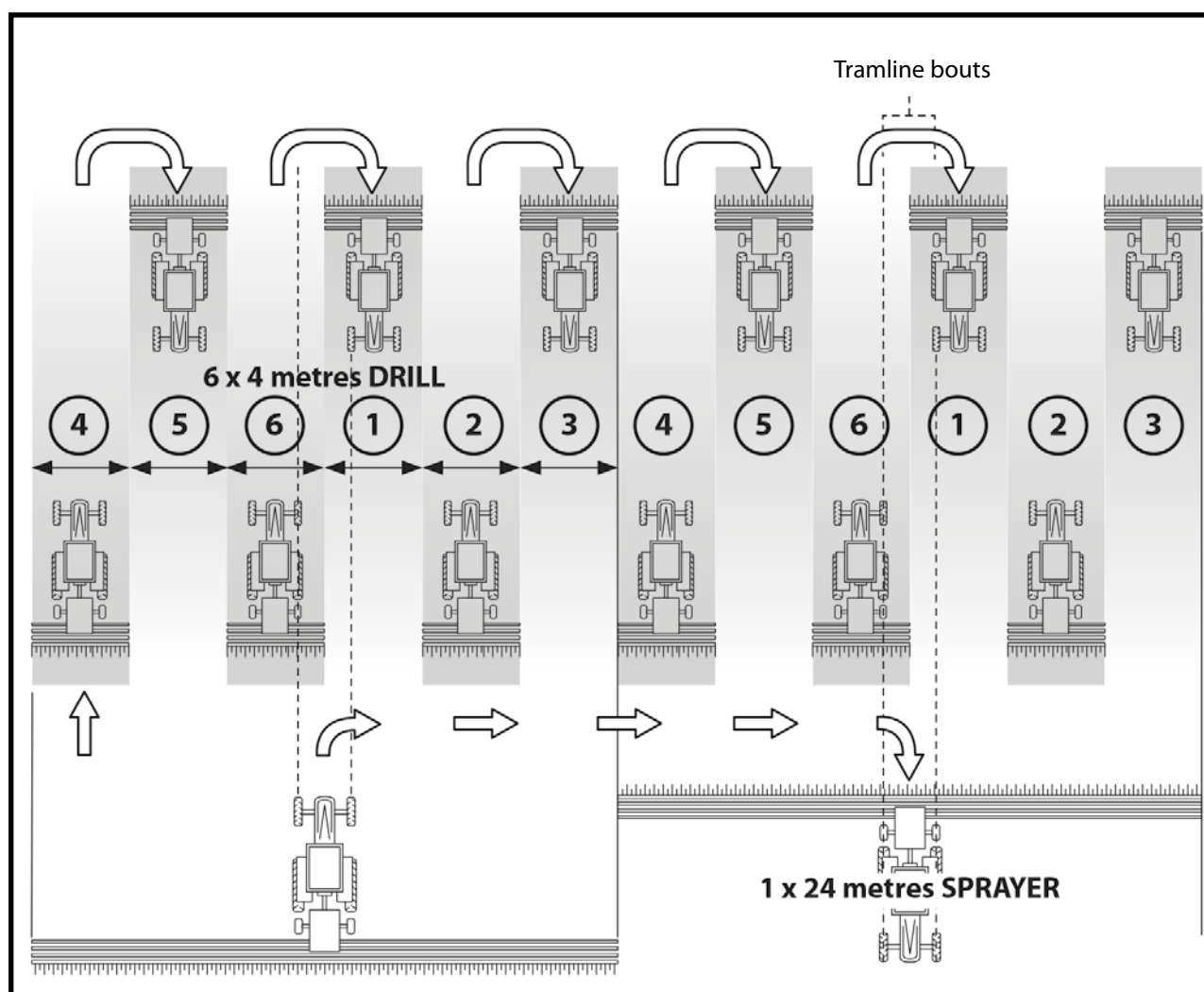

10 Bout Tramlining Sequence

For use with 4 metre drill/10 metre sprayer, or 8 metre drill/20 metre sprayer combinations. (2 x 2 left hand seed spouts are closed on bouts 4 and 7, and 2 x 2 right hand seed spouts closed on bouts 2 and 9). Starting on bout 1 requires turning RIGHT at the end of the first bout.



NOTE TO TURN LEFT AT THE END OF THE FIRST BOUT, ADVANCE THE BOUT NUMBER TO 6 BEFORE COMMENCING DRILLING.

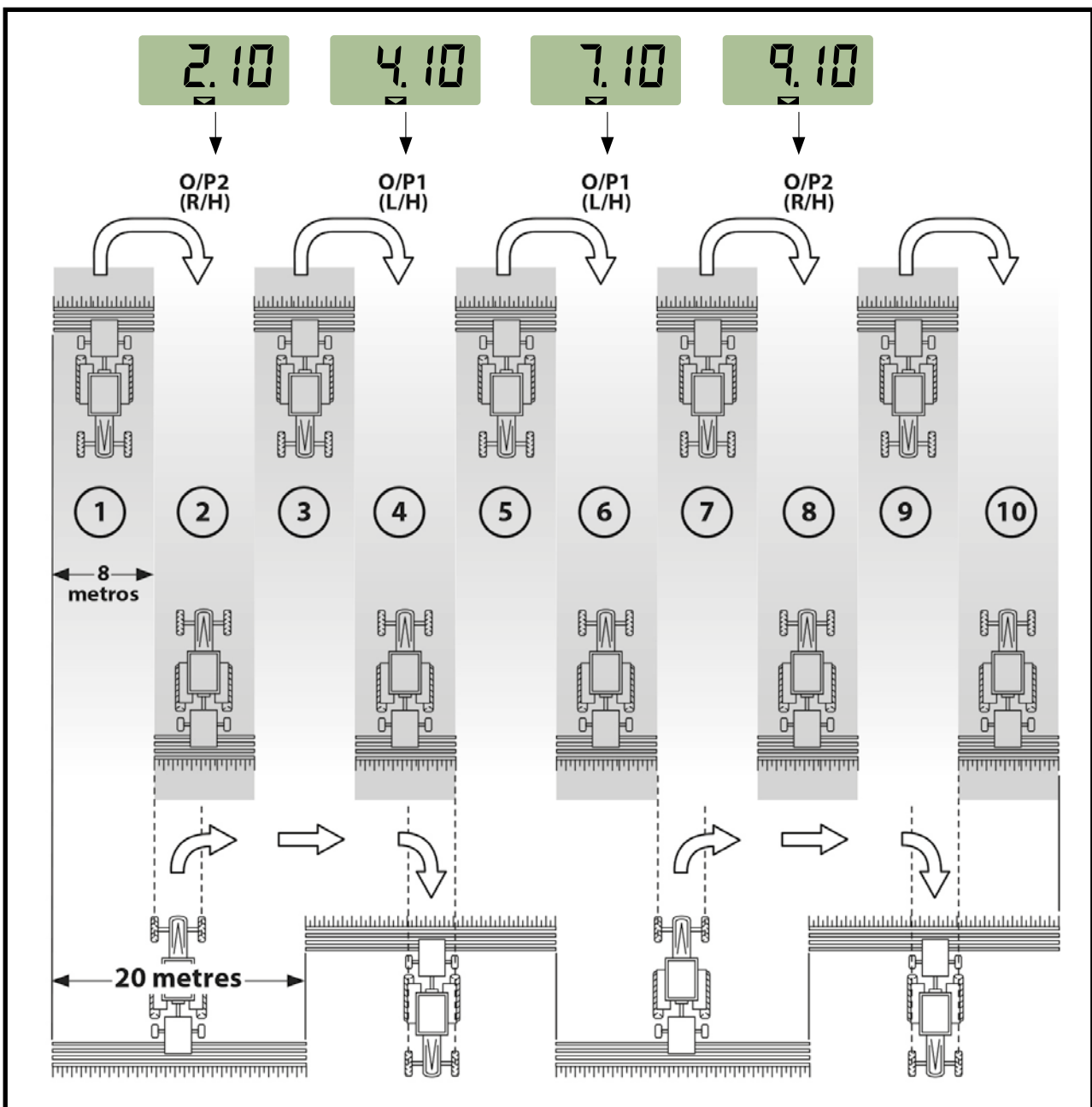

18 Bout Tramlining Sequence

For use with 4 metre drill and an 18 metre sprayer. (2 x 2 left hand seed spouts are closed on bouts 3 and 16, and 2 x 2 right hand seed spouts closed on bouts 7 and 12). Starting on bout 1 requires turning RIGHT at the end of the first bout.



NOTE: TO TURN LEFT AT THE END OF THE FIRST BOUT, ADVANCE THE BOUT NUMBER TO 10 BEFORE COMMENCING DRILLING.

The instrument will beep once the beginning of each tramline bout and the display will flash for the duration of the tramline bout.

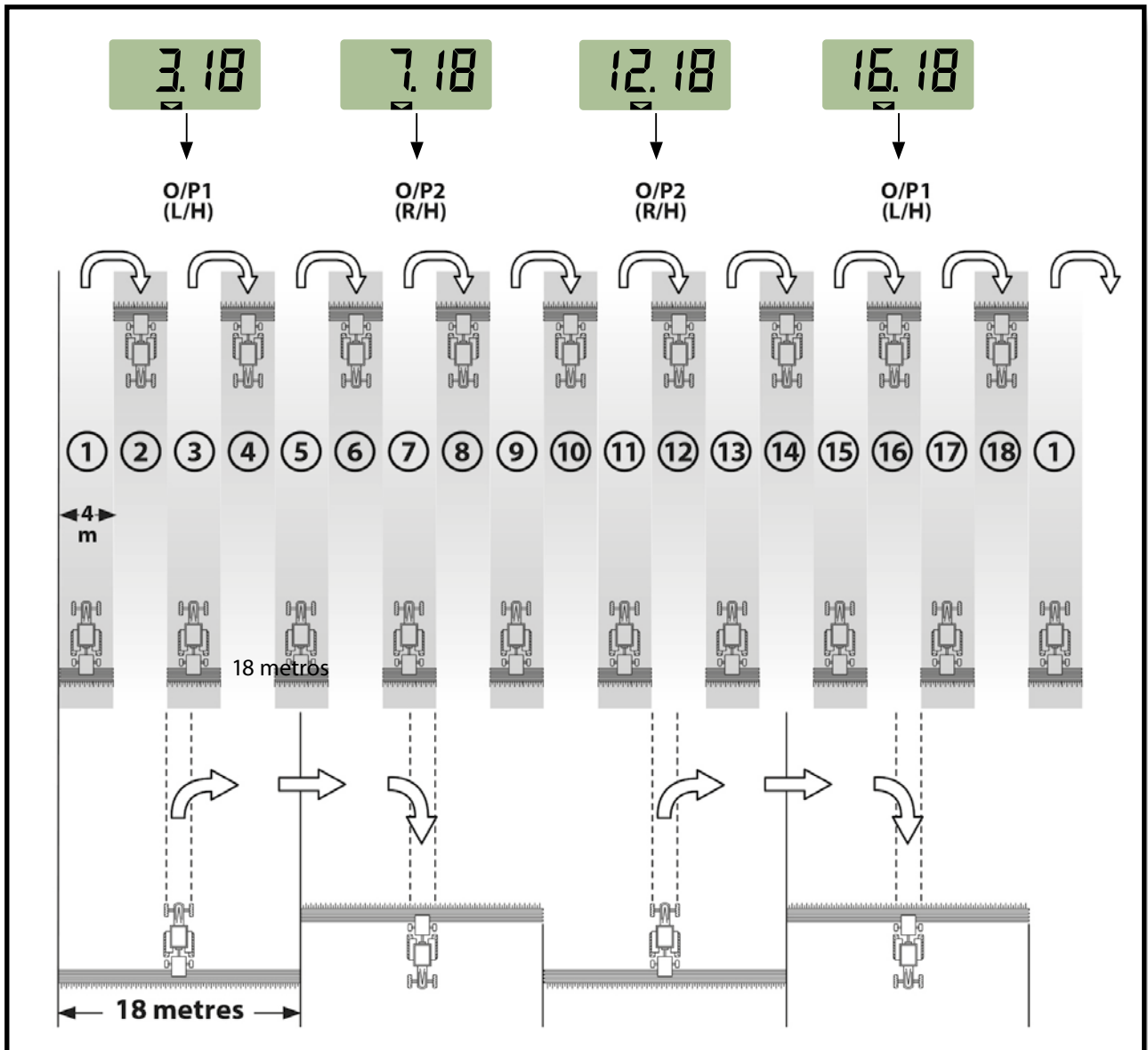

Selecting the Tramline Sequence

1- Select the  channel.

2- Hold  to enter programme mode 1.

After 5 seconds the first two digits flash, indicating the tramline sequence currently set:



'SY' = Symmetric

'AL' = Asymmetric Left

'Ar' = Asymmetric Right

'AS' = Special Asymmetric sequence
e.g. 10 bout and 18 bout.



3- Continue holding the  button and press and HOLD the  button to select the required sequence.

Setting the Tramline Bout

1- PRESS and RELEASE the  button to toggle between the tramline sequence and tramline bout number display.

The 3rd and 4th digits flash indicating the tramline bout number currently set.

2- PRESS and RELEASE the  button to cycle the tramline bout from 1 to 15.

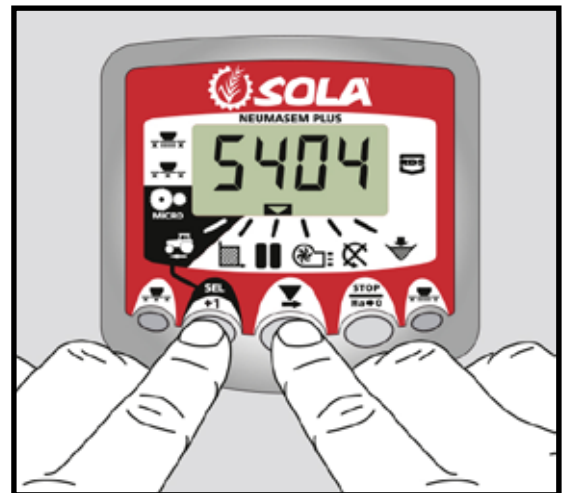

8.5 FAN RPM / FAN ALARMS – C4



To display the fan's speed in rpm

Select channel 4 using the central button .

Fan alarms

The fan's minimum turning speed can be programmed.
Under 2 Km/h these alarms will deactivate.





Fan's minimum speed

- 1- Select channel 4.
- 2- Press and hold  button for more than 5 seconds.
- 3- Hold it and press the  to change value and digits as explained in former cases.
Default speed is 3800 rpm.
- 4- Release all buttons to resume the normal position.

Selecting the fan's number of impulses per revolution (default value is set to 2).

PLEASE NOTE

FAN'S NUMBER OF IMPULSES PER REVOLUTION SHOULD ALWAYS BE 2. ONLY USE THIS PROGRAMMING MODE IN CASE OF MALFUNCTION.

- 1- TO SELECT PROGRAMMING MODE 2, PRESS  (MONITOR NEUMASEM) OR  (MONITOR NEUMASEM PLUS) BUTTON WHILE SWITCHING ON THE SCREEN USING REAR SWITCH.
- 2- PRESS  (MONITOR NEUMASEM) OR  (MONITOR NEUMASEM PLUS) TO CHANGE THE CHANNEL AND SELECT CHANNEL 4 (FAN).
- 3- PRESS AND HOLD THE  TO MODIFY THE FLICKERING DIGIT (IT SHOULD ALWAYS BE 2).
- 4- RELEASE THE BUTTON TO CHANGE BACK TO NORMAL POSITION.

8.6 SEED SHAFT RPM – C5

Select channel 5 using the central button .

40 seconds after the seed shaft stops turning, an alarm beeps 5 times consecutively. If it remains still, this alarm will repeat every 30 seconds.



To turn off the beeping, switch off the screen and switch it on again. This alarm will deactivate under 2 Km/h.

The seed shaft's alarm can be deactivated by pressing the button  for more than 5 seconds on the selected channel. The screen will display "Off". In this situation the alarm will not be activated even if the screen is switched off and on again.

8.7 HOPPER LOW LEVEL ALARM – C6

When the seed level is below the sensor, an alarm is activated and beeps 5 times consecutively. In this case the screen will display «**ALA**».

Activate and deactivate hopper level alarm

- 1- Select channel 6 using the central button .
- 2- Press and hold  button and...
- 3- Press the central button to select "0" (alarm is off) or "1" (alarm is on).
- 4- Release the buttons to change back to the normal position.

8.8 TOTAL SOWING SHUT-OFF (OPTIONAL)



NEUMASEM electronic controller

Press  to **lock** the seed's exit. The screen will display the flickering text «**CORT**».

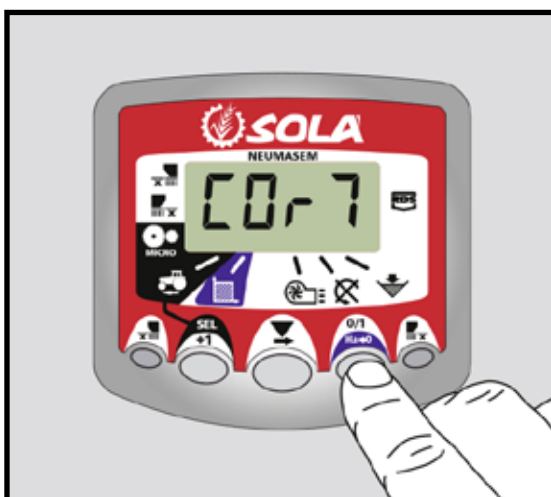
Press  again to **unlock** the seed's exit and return to a normal working position. The screen will display the flickering text «**OPEN**».



NEUMASEM PLUS electronic controller

Press , to **lock** the seed's exit. The screen will display the indicating arrow and the text «**CORT**» will be displayed every 2 seconds «**CORT**». Press  again to **unlock** the seed's exit and return to a normal working position. The screen will display the flickering text «**OPEN**».

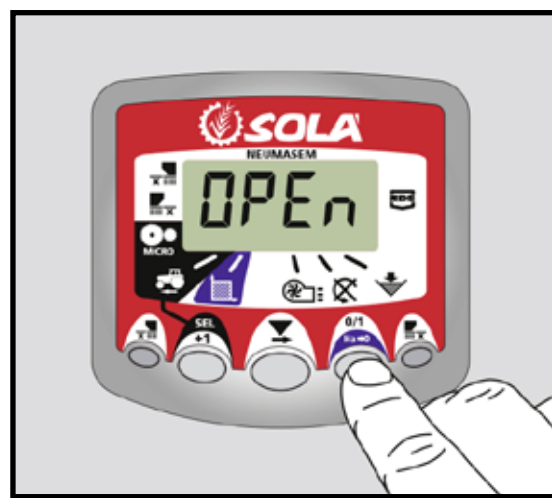
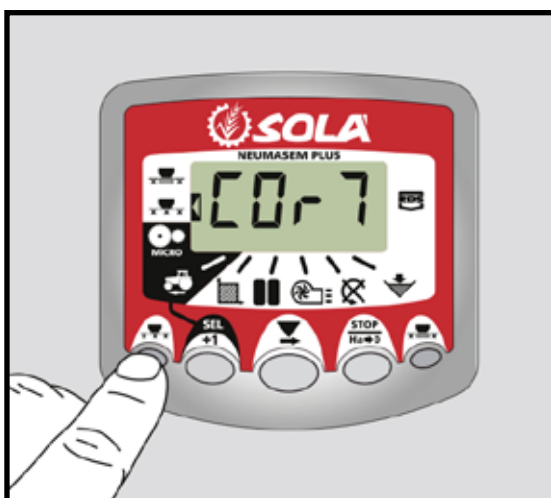

8.9 SHUT-OFF SOWING FROM FOLDING PARTS (OPTIONAL)



NEUMASEM electronic controller

Press  to **lock** the seed's exit from the arms on the folding parts (exits on the left and right sides of the folding parts will lock). The screen will display the indicating arrow.

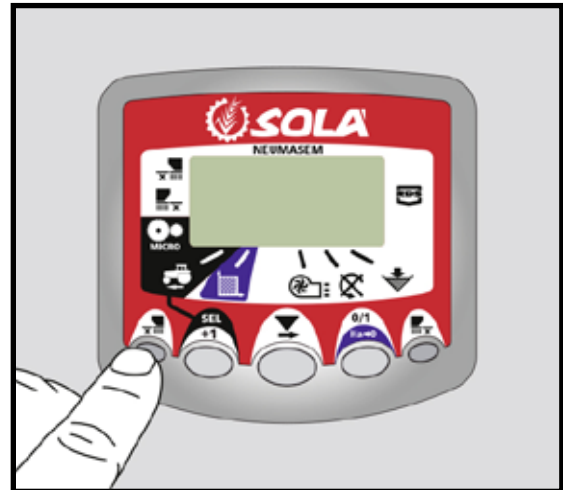
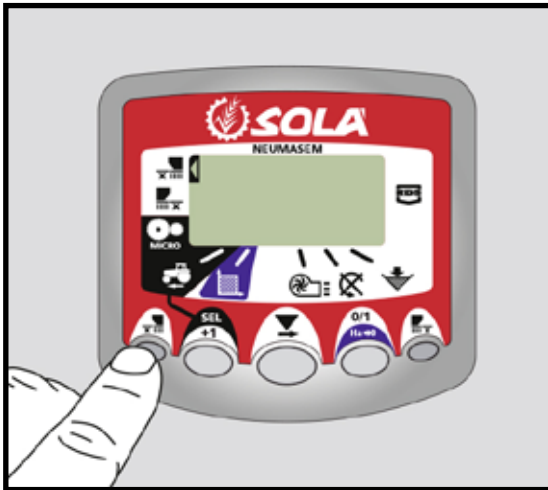

Press  again to **unlock** the seed's exit and change back to normal position.

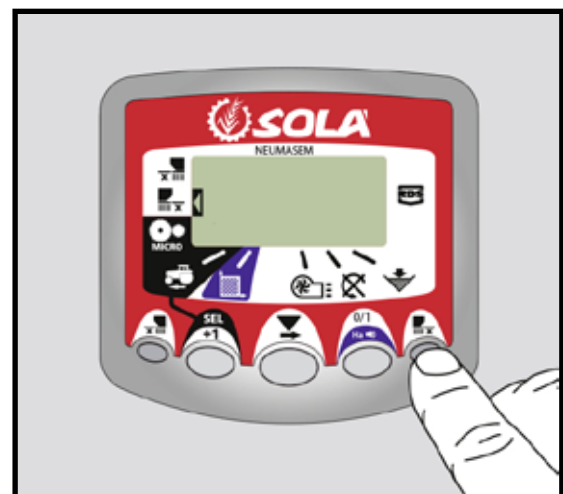
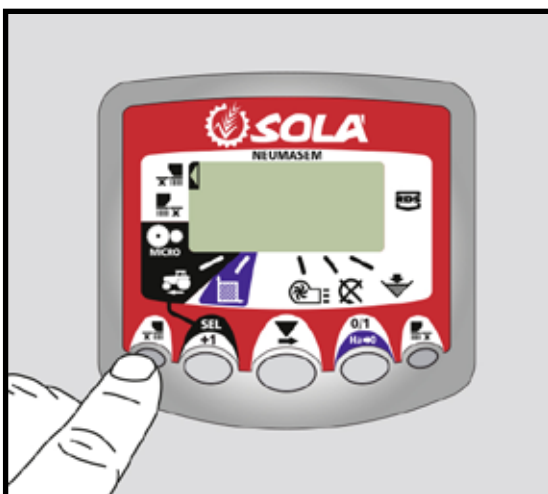

NEUMASEM electronic controller for independent folding parts

To **lock** the seed's exit from the arms on the folding parts, press  (to **lock** the left side in the driving direction) or  (to **lock** the right side in the driving direction). The screen will display the indicating arrow.



Press  or  again to **unlock** the seed's exit and change back to normal position.

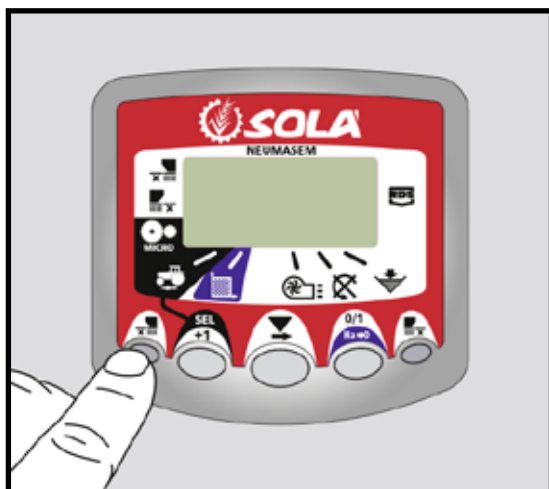

NEUMASEM PLUS electronic controller

Press  to **lock** the seed's exit from the arms on the folding parts. The screen will display an arrow indicating the selected mode.

Press  again to **unlock** the seed's exit and change back to normal position.

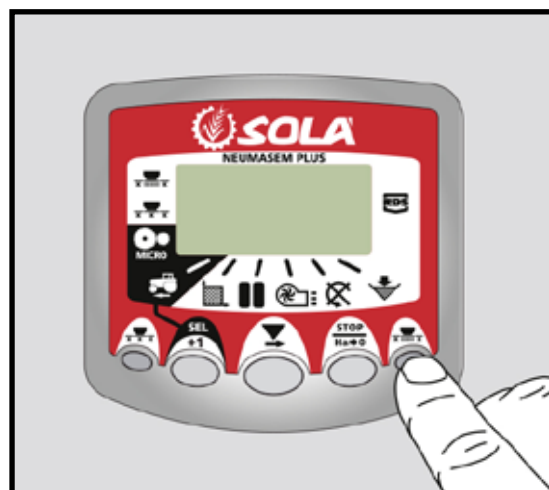
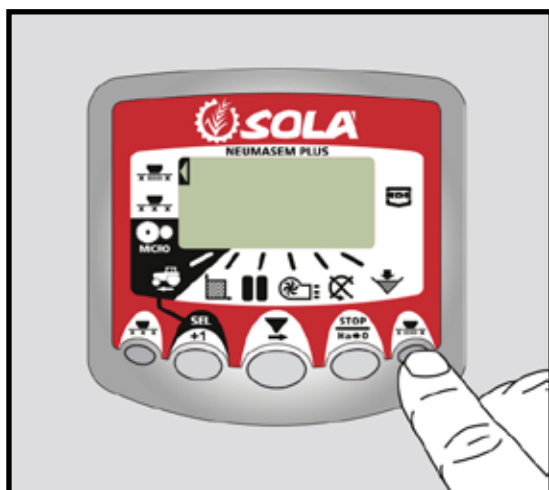

9- MAINTENANCE

9.1 LUBRICATION

The following parts should be lubricated with SOLID CALCIUM GREASE.

- All the joints of the cardan shaft should be greased, **daily**.
- The joints of the folding parts should be greased, **every 100 Ha**.
- Both the wheel's and transmission's bushings should be, **every 400 Ha**.
- Transmission chain should be grea-sed, **once a year**.



AFTER FINISHING A SOWING SEASON, ALL CHAINS AND JOINTS SHOULD BE CLEANED AND GREASED.

9.2 SCREWS

All the screws used in the seed drill are size 8.8.



AFTER WORKING FOR SOME HOURS, ALL SCREWS SHOULD BE CHECKED AND TIGHTENED.

9.3 DISTRIBUTOR HEAD AND SEED HOSES

Before starting work, check that the distributor head and the seed hoses are not blocked. To perform the check, follow these steps:

- 1- Make sure that the fan is on and the hopper is full. Use then the crank provided to turn the wheel controlling the distributor's transmission a few times.
- 2- Check that the seeds are coming out from every tine coulters.



IF ANY ABNOMALITY SHOWS UP, DO AS FOLLOWS:

- 1- STOP the machine so that the fan is off.
- 2- Take apart the cap of the distributor's head.
- 3- Check that there are no foreign bodies inside.
- 4- Remove foreign bodies in the case that they exist.

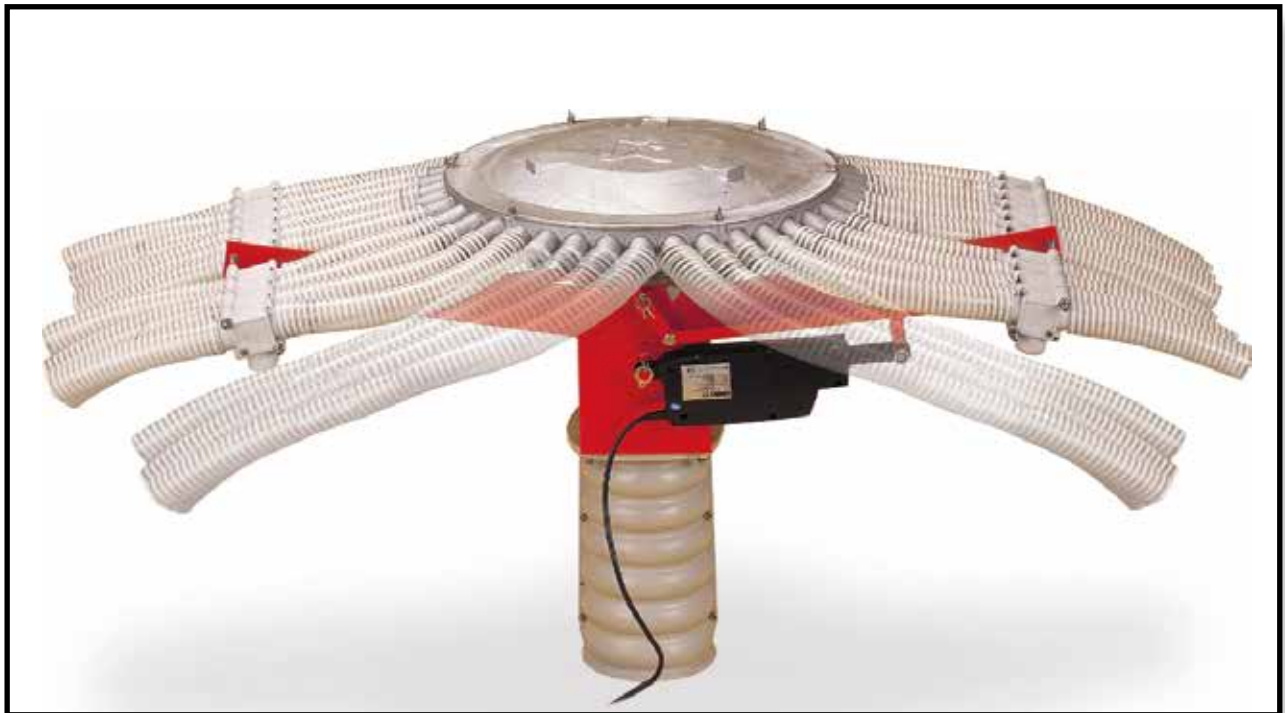

10- DOSAGE TABLE



INDICATED QUANTITIES SHOWN IN THE FOLLOWING TABLE SHOULD BE CONSIDERED FOR GUIDANCE ONLY, FORESEEN FLOWS CAN VARY DEPENDING ON THE ACCIDENTAL PRESENCE OF DISINFECTING PRODUCTS, UNEVEN SEED SIZE, DENSITY, HUMIDITY, ETC.



FOR PRECISION SOWING, FOLLOW DOSING PROCESS DESCRIBED IN SECTION 6 OF THIS MANUAL.

	WHEAT	RYE	BARLEY	OATS	BEANS	PEAS	LUPIN	CAROB	CORN	CORN		RAPE	FIELD CLOVER	GRASS	TURNIPS					
Spec. weighth (kg/l)	0,77	0,74	0,68	0,5	0,85	0,81	0,76	0,83	0,79	0,36	Spec. weighth (kg/l)	0,65	0,77	0,39	0,7					
Adj. dosing scale value	Regular seeds kg/ha (Bolt in position N)										Adj. dosing scale value	Fine seeds kg/ha (Bolt in position F)								
10	31,9	31,9	30,7	22,7	21,6	20,4	26,8	30,7	7,7	-	2,5	2,04	1,02	2,17	1,10	-	-	2,43	1,15	
15	48,5	47,3	46,0	33,0	39,6	38,3	43,5	48,5	23,0	17,9	5	4,35	2,17	4,99	2,43	-	-	4,35	2,30	
20	66,5	63,9	61,3	44,3	58,7	56,3	58,7	66,5	44,7	24,3	7,5	6,51	3,19	8,18	4,09	2,68	1,34	7,15	3,53	
25	81,9	79,3	75,4	54,6	75,4	74,1	75,4	85,6	66,5	31,9	10	8,69	4,35	11,54	5,75	4,99	2,43	9,58	4,79	
30	99,7	95,8	90,7	68,0	93,3	93,3	92,0	103	88,2	39,6	12,5	10,82	5,49	14,74	7,29	6,90	3,45	12,06	6,01	
35	117	112	106	78,3	111	112	108	122	110	47,3	15	13,19	6,51	17,21	8,69	8,82	4,41	14,32	7,15	
40	134	128	122	89,7	129	130	124	139	132	-	17,5	15,25	7,54	20,30	10,10	10,72	5,37	16,70	8,38	
45	150	144	137	101	147	148	140	159	149	-	20	17,42	8,69	22,98	11,54	12,68	6,27	19,17	9,58	
50	166	161	153	112	165	166	158	176	167	-	22,5	19,68	9,84	25,46	12,68	14,32	7,15	20,61	10,30	
55	184	176	166	124	182	186	174	194	186	-	25	21,85	10,82	26,28	13,19	15,56	7,79	22,05	11,03	
60	201	192	182	135	201	204	190	212	203	-		N	F	N	F	N	F	N	F	
65	218	208	197	147	218	223	207	231	222	-	N= regular speed F= microdosing									
70	236	225	212	159	236	240	224	249	239	-	PREVIOUS FLOW TEST									
75	254	241	228	170	255	258	240	267	256	-	Seed drill	Turns								
80	270	258	241	181	271	276	257	285	273	-	400	27,4								
85	285	275	257	192	289	297	273	303	292	-	450	24,4								
90	303	289	272	203	307	314	289	322	309	-	500	22,0								
95	321	305	288	214	324	332	307	340	327	-	600	18,3								
100	337	322	303	226	341	350	322	358	345	-	Number of turns performed to the small wheel to simulate the sowing of 250m ² . Flow in kg/ha is obtained by multiplying collected weight by 40.									
105	353	339	318	238	358	369	339	377	364	-										
110	371	356	334	249	377	387	356	395	381	-										

TABLE FOR ARES-2713 WITH FLOTATION WHEELS 10.0/75-15,3

When the amounts to be sown are very small (dosing scale value <= 10), a more uniform sowing can be obtained using microdosing, even in the case of regular seeds (cereal and big seeds).

DOSAGE TABLE

	WHEAT	RYE	BARLEY	OATS	BEANS	PEAS	LUPIN	CAROB	CORN	CORN		RAPE	FIELD CLOVER	GRASS	TURNIPS					
Spec. weight (kg/l)	0,77	0,74	0,68	0,5	0,85	0,81	0,76	0,83	0,79	0,36	Spec. weight (kg/l)	0,65	0,77	0,39	0,7					
Adj. dosing scale value	Regular seeds kg/ha (Bolt in position N)										Adj. dosing scale value	Fine seeds kg/ha (Bolt in position F)								
10	31	31	29,8	22	21	19,8	26	29,8	7,44	-	2,5	1,98	0,99	2,11	1,07	-	-	2,36	1,12	
15	47,1	45,9	44,6	32	38,4	37,2	42,2	47,1	22,3	17,4	5	4,22	2,11	4,84	2,36	-	-	4,22	2,23	
20	64,5	62	59,5	43	57	54,6	57	64,5	43,4	23,6	7,5	6,32	3,1	7,94	3,97	2,6	1,3	6,94	3,43	
25	79,5	76,9	73,2	53	73,2	71,9	73,2	83,1	64,5	31	10	8,43	4,22	11,2	5,58	4,84	2,36	9,3	4,65	
30	96,7	93	88	66	90,5	90,5	89,3	100	85,6	38,4	12,5	10,5	5,33	14,3	7,07	6,7	3,35	11,7	5,83	
35	114	109	103	76	108	109	105	118	107	45,9	15	12,8	6,32	16,7	8,43	8,56	4,28	13,9	6,94	
40	130	124	118	87	125	126	120	135	128	-	17,5	14,8	7,32	19,7	9,8	10,4	5,21	16,2	8,13	
45	146	140	133	98	143	144	136	154	145	-	20	16,9	8,43	22,3	11,2	12,3	6,08	18,6	9,3	
50	161	156	148	109	160	161	153	171	162	-	22,5	19,1	9,55	24,7	12,3	13,9	6,94	20	9,99	
55	179	171	161	120	177	180	169	188	180	-	25	21,2	10,5	25,5	12,8	15,1	7,56	21,4	10,7	
60	195	186	177	131	195	198	184	206	197	-		N	F	N	F	N	F	N	F	
65	212	202	191	143	212	216	201	224	215	-	N= regular speed F= microdosing									
70	229	218	206	154	229	233	217	242	232	-	PREVIOUS FLOW TEST									
75	246	234	221	165	247	250	233	259	248	-	Seed drill		Turns							
80	262	250	234	176	263	268	249	277	265	-	400	26,5								
85	277	267	249	186	280	288	265	294	283	-	450	23,5								
90	294	280	264	197	298	305	280	312	300	-	500	21,2								
95	311	296	279	208	314	322	298	330	317	-	600	17,7								
100	327	312	294	219	331	340	312	347	335	-	Number of turns performed to the small wheel to simulate the sowing of 250m ² . Flow in kg/ha is obtained by multiplying collected weight by 40.									
105	343	329	309	231	347	358	329	366	353	-										
110	360	345	324	242	366	376	345	383	370	-										

TABLE FOR ARES-2713 WITH FLOTATION WHEELS 340-50.16

When the amounts to be sown are very small (dosing scale value ≤ 10), a more uniform sowing can be obtained using microdosing, even in the case of regular seeds (cereal and big seeds).

11- NOTES

DATE	NOTES

MAQUINARIA AGRÍCOLA SOLÁ, S.L.

Ctra. de Igualada, s/n. Apdo. Correos, 11
08280 CALAF (Barcelona) **ESPAÑA**

Tel. 34 93 868 00 60

Fax. 34 93 868 00 55

www.solagrupo.com

e-mail: sola@solagrupo.com

