

KIBLI 2010

STARTING MANUAL

MAINTENANCE

DOSAGE

SPARE PARTS

Please read and follow this operating manual before putting the machine into operation.



MAQUINARIA AGRÍCOLA

 **SOLA**

SOLÀ seed drills, fertiliser spreaders and front hoppers are manufactured in a highly specialized environment and our factory has a vast network of satisfied customers.

SOLÀ machines use highly advanced technology and are guaranteed to work without malfunctions in a large variety of conditions. They **SOLÀ** machines are provided with easy-to-use and efficient devices and perform excellently with only minimum operator maintenance.

This manual will help you use your **SOLÀ** product with the maximum efficiency.



CERTIFIED QUALITY SYSTEM

2ND Edition – Desember 2014

Ref.: CN-811073/GB

Created by: SOLÀ

It is forbidden to copy any part of this manual.

Specifications are subject to change or modification without notice.

The pictures included do not necessary show the standard version.

TABLE OF CONTENTS

1. INTRODUCTION	5
2. TECHNICAL CHARACTERISTICS	6
2.1 OVERVIEW	6
2.2 TECHNICAL CHARACTERISTICS	6
2.3 MACHINE IDENTIFICATION	7
2.4 STANDARD EQUIPMENT	7
2.5 OPTIONAL EQUIPMENT.....	7
3. SAFETY INSTRUCTIONS	8
3.1 SAFETY SYMBOLS	8
3.2 USE ACCORDING TO DESIGN.....	9
3.3 GENERAL SAFETY REGULATIONS	10
3.4 LOADING AND UNLOADING INSTRUCTIONS	11
4. ESSENTIAL SOWING CONCEPTS	12
4.1 TERRAIN	12
4.2 SEEDS.....	12
4.3 SEED PLANTING DEPTH	12
5. ESSENTIAL FERTILISING CONCEPTS	14
5.1 FACTORS TO BE TAKEN INTO ACCOUNT FOR A GOOD FERTILISATION	14
6. STARTING	15
6.1 COUPLING THE FRONT HOPPER TO THE TRACTOR.....	15
6.2 CONNECTIONS.....	16
6.3 LOADING THE HOPPER MANUALLY	17
6.4 SUPPORTING LEGS	18
7. DOSAGE	19
7.1 SEED / FERTILISER GRAIN OF REGULAR SIZE (POSITION N)	20
7.2 FINE SEED / FERTILISER GRAIN (MICRODOSING – POSITION F)	20
7.3 CALIBRATION TEST.....	21
7.4 COMPLEMENTARY DOSING TESTS.....	23
7.4.1 TEST TO DETERMINE THE NUMBER OF WHEEL TURNS.....	23
7.4.2 SEED DOSING ADJUSTMENTS	25
7.4.3 FERTILISER DOSING ADJUSTMENTS.....	27
8. TYPES OF DISTRIBUTION	29
8.1 FERTILISER DISTRIBUTION BY MECHANICAL FAN	29
8.2 FERTILISER DISTRIBUTION BY HYDRAULIC FAN.....	30
9. NEUMASEM ELECTRONICAL CONTROLLER	31
9.1 FRONT PANEL DESCRIPTION	31
9.2 FORWARD SPEED - C1	32
9.3 TOTAL AREA / WORKING WIDTH – C2.....	33
9.4 FAN RPM / FAN ALARMS – C4	34
9.5 METERING BOX'S SHAFT RPM– C5	35
9.6 HOPPER LOW LEVEL ALARM – C6.....	36
10. MAINTENANCE	37
10.1 CHECKING FREQUENCY.....	38
10.2 GREASING AND LUBRICATING.....	40
10.3 FANS	41
10.4 FRONT HOPPER CLEANING.....	41
11. DOSAGE TABLES	42
11.1 SEED MICRODOSING	42
11.2 REGULAR SEEDS DOSING.....	46
11.3 FERTILISER DOSING IN MACHINES EQUIPPED WITH TINE COULTERS	53
11.4 FERTILISER DOSING IN PLANTERS.....	57
12. WARRANTY	62

13. SPARE PARTS	63
13.1 DISTRIBUTOR.....	64
13.2 MECHANICAL TRANSMISSION	66
13.3 HYDRAULIC FAN	68
14. NOTES	71

1. INTRODUCTION

It is essential to read and follow the instructions and recommendations in this manual before operating **the front hopper KIBLI**. Careful reading enables maximum operator efficiency, prevents accidents and damage, and increases the front hopper's capacity and life expectancy.

Please ensure that this manual has been read by any person involved in performing operational tasks, (including preparation, dealing with mechanical problems and supervising the machine), maintenance (inspection and technical assistance) and transport.

For your safety, please follow these technical safety instructions as SOLÀ will not be responsible for damages caused by not observing the information provided.

In the first chapters you will find the Technical Characteristics and Safety Instructions. Basic concepts that are required to operate the machine are explained in the Starting, Adjusting and Maintenance sections.

The last part of this manual consists of Dosage Tables for seeds and fertiliser.



SOLÀ RETAINS THE RIGHT TO MODIFY ILLUSTRATIONS, TECHNICAL DATA AND WEIGHTS INDICATED IN THIS OPERATING MANUAL, IF THESE CHANGES HELP TO IMPROVE THE QUALITY OF THE MACHINES.

In this operating manual you will find three different symbols relating to safety:



TO WORK MORE EASILY WITH THE FRONT HOPPER.



TO PREVENT DAMAGE TO THE FRONT HOPPER AND OPTIONAL EQUIPMENT.



TO PREVENT PHYSICAL INJURY.

2. TECHNICAL CHARACTERISTICS

2.1 OVERVIEW



2.2 TECHNICAL CHARACTERISTICS

CHARACTERISTICS	KIBLI 2010
Hopper capacity (Litres)	2.000
Curb weight (Kg)	850
Full load weight (Kg)	2350
Width (m)	2,55
Length (m)	1,5
Height (m)	1,6

2.3 MACHINE IDENTIFICATION

All machines have an IDENTIFICATION PLATE, where the following data is specified:

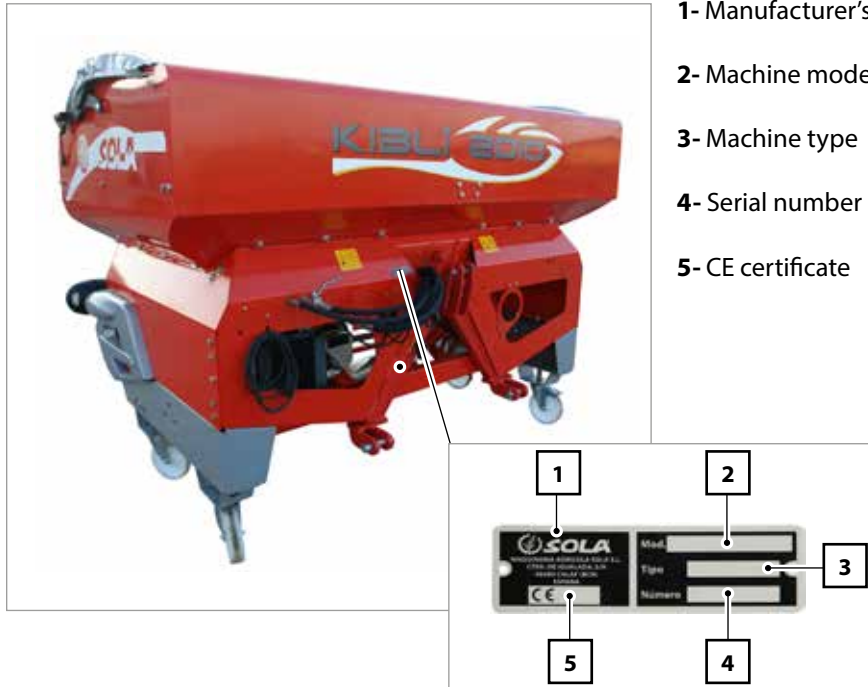

2.4 STANDARD EQUIPMENT

- Scales and seed counter.
- Folding hydraulic transmission starwheel or electrical transmission.
- 2000 L Hopper.
- Hopper's folding cover.
- Metering box for fertiliser and small or big seeds.
- Platform to gain access to the hopper.
- Supporting legs.
- Front lights.
- Sieves in the hopper.
- Hydraulic fan.
- Sowing electronical controller Neumasem or Artemis Lite.

2.5 OPTIONAL EQUIPMENT

- Mechanical fan.

3. SAFETY INSTRUCTIONS

3.1 SAFETY SYMBOLS

On the machine you will find the following warning pictograms:



READ THE INSTRUCTIONS CAREFULLY AND OBSERVE THE SAFETY ADVICE GIVEN IN THE OPERATING MANUAL.



DURING THE COUPLING MANOEUVRE, STAY AWAY FROM THE FRONT PART OF THE TRACTOR. RISK OF SERIOUS PHYSICAL INJURY.



DURING MAINTAINING OR REPAIRING THE MACHINE, YOU MUST STOP THE TRACTOR'S ENGINE COMPLETELY AND REMOVE THE IGNITION KEY.



RISK OF BEING CRUSHED WHEN WORKING UNDER THE MACHINE, PLEASE SECURE THE MACHINE TO PREVENT THIS RISK. RISK OF SERIOUS PHYSICAL INJURIES.



NEVER USE THE LADDER TO ACCESS THE PLATFORM WHEN THE MACHINE IS RUNNING. IT IS FORBIDDEN TO RIDE ON THE MACHINE DURING OPERATION. RISK OF SERIOUS PHYSICAL INJURIES.



DANGER OF INFECTION FROM ESCAPING HYDRAULIC FLUID AT HIGH PRESURE! THIS CAN INFLICT SERIOUS INJURIES WITH POTENTIALLY FATAL CONSEQUENCES IF IT PASSES THROUGH THE SKIN AND INTO THE BODY. KEEP THE HOSE LINES IN GOOD CONDITION. RISK OF SERIOUS PHYSICAL INJURIES.



RISK OF INJURIES TO THE EXTREMITIES BY BEING TRAPPED.



DO NOT EXCEED MAXIMUM LOAD.



COUPLING POINT FOR LOADING AND UNLOADING THE MACHINE BY CRANE.



DO NOT INSERT YOUR HAND INTO THE HOPPER WHILE THE DRIVE WHEEL IS TURNING. RISK OF SERIOUS PHYSICAL INJURY.

3.2 USE ACCORDING TO DESIGN

- The **KIBLI** front hopper has been specifically designed to be used as **FRONT DOSING HOPPER** for seeds or fertiliser.
- If the machine is used in circumstances other than the above, SOLÁ will not be held responsible for any damage caused (see section 12. WARRANTY)
- The user must observe all regulations concerning safety, traffic and hygiene.
- If the machine is modified by the user, the manufacturer's warranty is cancelled. SOLÁ will not be held responsible for any damage caused (see section 12. WARRANTY).



3.3 GENERAL SAFETY REGULATIONS



BEFORE STARTING THE MACHINE, PLEASE CHECK THE MACHINE IS IN GOOD CONDITION FOR WORK AND IS SAFE FOR ROAD USE.



BEFORE STARTING THE MACHINE, CHECK THAT VISIBILITY IS CLEAR AROUND THE MACHINE AND THERE IS NO PERSON IN THE WORKING AREA.



IN THOROUGHFARE, PLEASE OBSERVE TRAFFIC SIGNS AND REGULATIONS.



IT IS FORBIDDEN TO RIDE ON THE MACHINE DURING OPERATION OR TRANSPORT. RISK OF SERIOUS PHYSICAL INJURIES.



BEFORE USING THE MACHINE, THE USER MUST BE FAMILIAR WITH ALL OPERATING ELEMENTS.



PLEASE BE EXTREMELY CAREFUL WHEN COUPLING AND UNCOUPLING THE MACHINE TO THE TRACTOR.



NEVER LEAVE THE DRIVER SEAT DURING OPERATION.



DO NOT DEPOSIT EXTERNAL ELEMENTS INSIDE THE HOPPER.



WHEN MAINTAINING THE HYDRAULIC SYSTEM OF THE FRONT HOPPER, MAKE SURE THAT IT IS DEPRESSURISED AND THE TRACTOR'S ENGINE IS OFF.



PLEASE REGULARLY CHECK THE CONDITION OF THE TUBES AND HOSEPIPES IN THE HYDRAULIC SYSTEM. THESE PARTS AGE NATURALLY AND THEIR LIFE SHOULD NOT SURPASS 6 YEARS. PLEASE REPLACE WHEN NECESSARY.



DURING TRANSIT WITH THE RAISED FRONT HOPPER, BLOCK THE LOWERING SWITCH. BEFORE LEAVING THE TRACTOR, LOWER THE FRONT HOPPER ONTO THE GROUND AND REMOVE THE TRACTOR'S STARTING KEY.



PLEASE CHECK THAT THE PTO SHAFT IS IN GOOD CONDITION AND WELL PROTECTED. PREVENT THE PROTECTIVE TUBE FROM TURNING BY HOLDING BOTH THE TUBE AND CHAIN PROVIDED FOR THIS PURPOSE.



ALWAYS USE ENOUGH SUPPORTING ELEMENTS WHEN MAINTAINING THE MACHINE IN A RAISED POSITION TO PREVENT THE MACHINE FROM LOWERING OR FALLING.



MOUNT THE PTO SHAFT ONLY WHEN THE TRACTOR'S ENGINE IS OFF.



BEFORE CONNECTING THE PTO SHAFT, BE SURE THAT THE DANGER ZONE SURROUNDING THE MACHINE IS CLEAR.

3.4 LOADING AND UNLOADING INSTRUCTIONS

Loading and unloading the machine must be performed, if possible, using a bridge crane.

The following pictures show the position of the tow ropes to perform this operation, going around (surrounding?) the hopper through the inside part of the frame. A different way of doing it is by using the three-point linkage (in this case, see chapter 6.1 COUPLING THE FRONT HOPPER TO THE TRACTOR).

To know the total weight that the bridge crane will need to bear, see section 2.2 TECHNICAL CHARACTERISTICS.



THESE OPERATIONS SHOULD BE PERFORMED ONLY BY QUALIFIED AND EXPERIENCED PERSONNEL.

4. ESSENTIAL SOWING CONCEPTS



WHEN STARTING THE MACHINE, FURROWS WILL NOT CONTAIN ANY SEEDS FOR A METRE.



WHEN STOPPING THE MACHINE, SEEDS WHICH WERE PREVIOUSLY INSIDE THE SEED HOSES, SLIDE FROM THE MACHINE AND END UP PILED ON THE GROUND. TAKE THIS INTO ACCOUNT WHEN STOPPING AND STARTING THE MACHINE IN ORDER TO ACHIEVE MORE ACCURACY.



ALWAYS WORK AT A UNIFORM SPEED AS SUDDEN ACCELERATING AND SLOWING DOWN WILL CAUSE AN IRREGULAR SEED DISTRIBUTION.

4.1 TERRAIN

The better the soil condition, the better the sowing quality. Work is more difficult on big clods or uneven furrows. Although SOLÀ machines resist harsh conditions, if the seedbed does not satisfy appropriate conditions then the sowing quality will suffer.

4.2 THE SEED

It is essential that seeds are well maintained and clean. Barley seeds should be trimmed.

4.3 SEED PLANTING DEPTH



THE RECOMMENDED SEED PLANTING DEPTHS ARE FROM 3 TO 5 CENTIMETRES. PLANTING TOO DEEP CAUSES PROBLEMS AS RHIZOME CANNOT REACH THE SURFACE AND THE PLANT WILL DIE. IT DOES NOT MATTER THAT SOME GRAINS ARE VISIBLE BECAUSE THE HARROW'S TINES WILL COVER THEM EVENTUALLY.

The seed planting depth has consequences for tillering, as well as for the plant's strength and its ability to resist frostbite or drought. The parent shoot grows from 1 to 2 cm under the ground, whatever the depth of the seed.

Planting deeper does not necessarily mean getting deeper roots. Only a few roots grow from the lower part of the seed. Most of them grow from a parent shoot close to ground level.

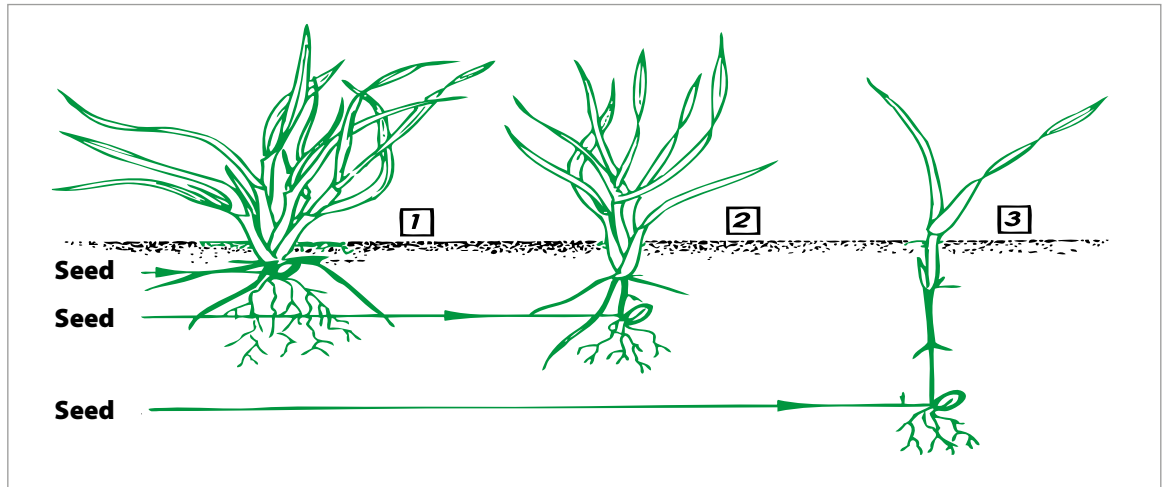

NORMAL PLANTING DEPTH: FROM 2 TO 4 CM

- Thick stem, short rhizome, resistant to frostbite
- Multiple tillering providing from 3 to 6 shoots and a lot of blades, from 6 to 10.
- Deep and thick roots, approximately 5 cm in width and 10-12 cm in depth.
- With less grains per sowing square metre, more ears are obtained.

DEEPER PLANTING: FROM 5 TO 6 CM

- Fine stem, rhizome exposed to frostbite.
- Late and weak tillering, 1 or zero shoots and only a few blades, 3-4 approx.
- Medium quality roots of approximately 3 cm in width and 5 cm in depth
- More grains per sowing square metre are required to obtain the same number of ears as in the previous case.

VERY DEEP PLANTING: FROM 8 TO 10 CM

- Very fine stem. No tillering and only one blade.
- Seed runs out of supplies by growing a long rhizome which frostbite can easily cut.
- The plant takes weak roots, approximately 1 cm in width and 3 cm in depth.
- Twice the number of grains per sowing metre are required to obtain the same number of ears as in the first case.



IN VERY COLD PLACES, REPEATED FROSTBITE CAN HAVE A HONEYCOMB EFFECT ON THE GROUND'S MOST SUPERFICIAL LAYER. IN THIS CASE THE PLANT'S VERY FIRST ROOTS CAN LOOSEN AND THE PLANT WILL DIE. SLIGHTLY DEEPER PLANTING IS RECOMMENDED AND IF POSSIBLE, THE USE OF ROLLERS TO COMPACT THE EARTH TO BETTER PROTECT THE SEEDS.

5. ESSENTIAL FERTILISING CONCEPTS



THE FRONT HOPPER SHOULD BE WELL WASHED AFTER THE WORK (SEE SECTION 10.4 FRONT HOPPER CLEANING). OTHERWISE THE FERTILISER REMAINING IN THE MACHINE COULD CORRODE AND DAMAGE IT

5.1 FACTORS TO BE TAKEN INTO ACCOUNT FOR A GOOD FERTILISATION

1- Forward speed:

To obtain a uniform fertilisation, keep the forward speed without sudden stops, since variations in forward speed modify the amount of fertiliser applied on the ground.

When starting and stopping, take into account the way in which the air circuit works. This circuit carries the fertiliser from the metering box to the metering units or to the coulter, and works as follows:

- When **STARTING**, the circuit is empty and the machine will not fertilise until it has run some metres.
- When **STOPPING**, the circuit is FULL of fertiliser. It is recommended to cut the fertilisation by raising the machine or by lifting the transmission starwheel a couple metres before stopping.

2- Check fertiliser's flow:

Perform a previous calibration test in the warehouse in order to know exactly the amount of fertiliser going to be spread. Dosage is going to be very different when using different kinds of fertiliser, as it depends on factors such as density, moisture content, etc..

3- Distance between tramlines:

Keeping the distance between tramlines is essential to get optimal fertilisation.

6. STARTING

6.1 COUPLING THE FRONT HOPPER TO THE TRACTOR

The front hopper KIBLI is equipped with a three-point linkage of category 3.

To couple the hopper to the tractor, follow these steps:

- 1- Fix the three-point linkage to the tractor using 3 bolts (1).
- 2- Loosen the screw (2) in order to free the hopper's safety lock (3).
- 3- Introduce the three-point linkage to the front hopper.
- 4- Make sure the trigger of the three-point linkage (4) has been correctly inserted.
- 5- Adjust the safety lock (3) using the screw (2).

To remove the three-point linkage from the hopper:

- 1- Uncouple the three-point linkage from the tractor by unscrewing the 3 bolts (1).
- 2- Loosen the screw (2) in order to free the hopper's safety lock (3).
- 3- Raise the hopper slightly (it must be in contact with the ground) and pull the lever (5) in order to free the three-point linkage from the hopper. Make sure that the trigger (4) is not locked.

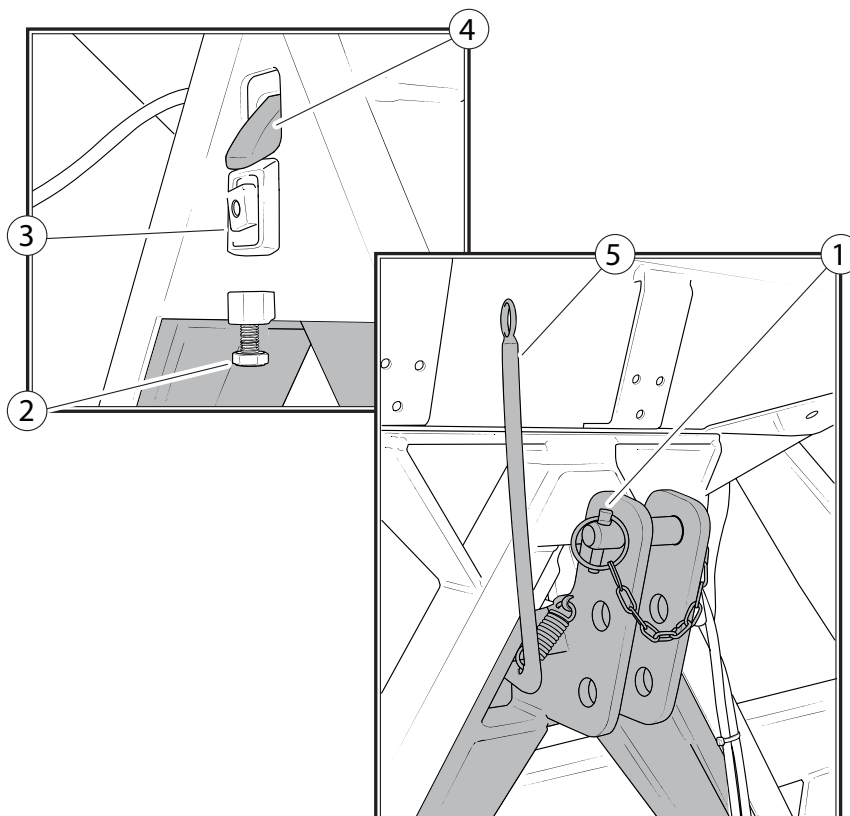



TO PERFORM THIS OPERATION, THE FRONT HOPPER'S WHEELS MUST BE BRAKED



WHILE PERFORMING THE COUPLING AND UNCOUPLING OPERATIONS, MAKE SURE THERE IS NO PERSON OR OBJECT BETWEEN THE TRACTOR AND THE FRONT HOPPER.

6.2 CONNECTIONS

Connect the ELECTRIC plug for the machine's FRONT LIGHTS.

The front hopper is equipped with the following HYDRAULIC connections:

To raise and lower the transmission starwheel:

- a single-acting connection.

If the machine is equipped with HYDRAULIC FAN:

- one single-acting connection and a free return line.

If the machine is equipped with a COOLING SYSTEM FOR THE MECHANICAL FAN:

- a double-acting connection.

If the machine model is equipped with a MECHANICAL FAN, the PTO shaft should be adapted:

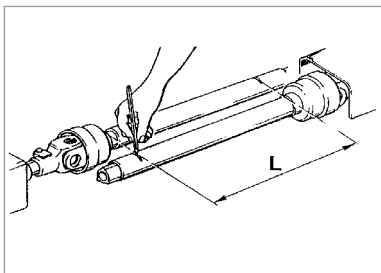

- 1- Dismount the PTO shaft and insert one end into the tractor's universal joint shaft and the other end into the front hopper. Look for the minimal movement length "L" by raising and lowering the hydraulic lift.

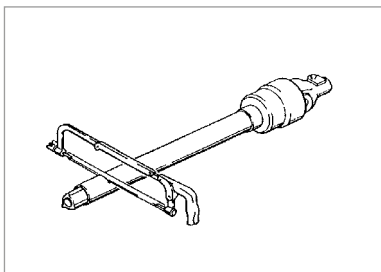

- 2- Cut the spare plastic and metal into parts of the same length and re-mount the PTO shaft.

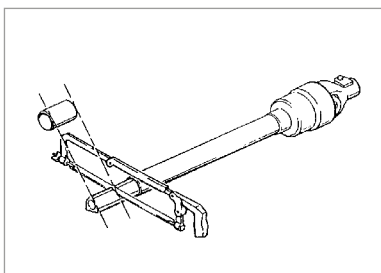

- 3- Operate the hydraulic lift and check that the PTO shaft's movement is correct.

- 4- Fix the PTO-shaft to the tractor using the securing chain.



WHEN OPERATING THE PTO SHAFT CHECK THAT THE ENGINE IS OFF. ALWAYS WORK WITH THE PTO SHAFT PROTECTED AND IN GOOD CONDITION. PREVENT THE PTO SHAFT'S TUBE FROM TURNING BY SECURING IT WITH THE CHAIN PROVIDED.



WHEN LOWERING THE FRONT HOPPER TO THE GROUND, UNPLUG THE TRACTOR'S UNIVERSAL JOINT SHAFT SO THAT THE PTO SHAFT DOES NOT HAVE AN EXCESSIVE INCLINATION (MAX. 35°).



WHEN HOLDING THE TRACTOR UNIVERSAL JOINT SHAFT'S CLUTCH IN, PERFORM IT GENTLY. STARTING SUDDENLY COULD SERIOUSLY DAMAGE THE MACHINE.

6.3 LOADING THE HOPPER MANUALLY



For access to the hopper, follow these steps:

1- Pull the safety trigger (1) to free the hopper's platform. Next, pull the platform until it is horizontal. To fold it, pull the safety trigger (1) and pull the platform upwards until it is locked with the trigger.

2- Pull to remove the elastic strap (2) that secures the hopper's folding cover.

3- At the sides of the hopper, there are handles. Use them to push forward and fold the cover over





4- Fill the machine with seeds or fertiliser without removing the sieves. Gaining access to the hopper to fill it manually is an easy operation. However, in order to fill the hopper in a quick and safe way, it is recommended to use a BIG BAG along with an approved small crane.

5- After filling the hopper, fold the cover back, place the elastic straps (2) and use the trigger to secure the platform (1).



6.4 SUPPORTING LEGS

The front hopper KIBLI is equipped with 4 supporting legs. These legs are wheels to load and unload the machine, so that transporting the machine becomes easier.



TWO OF THESE WHEELS HAVE A FOOT BRAKE TO BE USED WHEN STORING THE MACHINE OR WHEN TRANSPORTING IT ON A TRAILER.

7. DOSAGE

To gain access to the dosing system, the platform has to be unfolded (see point 1 from section 6.3 LOADING THE HOPPER MANUALLY).

There are two ways of dosing:

for regular seeds

for fine seeds with minimum flow rate

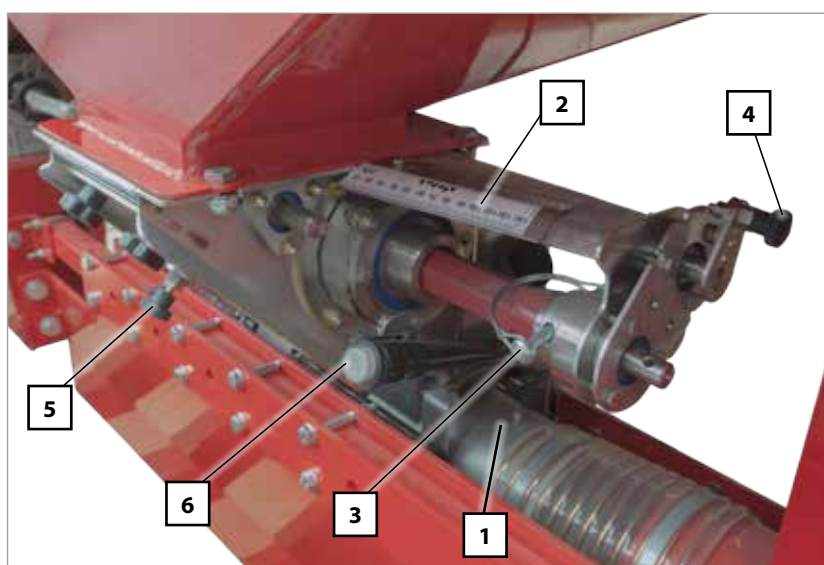

COMPONENT	
1	Venturi injector sluice
2	Dosing graduated scale
3	Bolt N=regular seed F=fine or small seed
4	Spindle
5	Trap-door to quickly empty the hopper and the metering box.
6	Button for the calibration test



WHILE THE MACHINE IS WORKING, THE HANDLE OF THE VENTURI INJECTOR SLUICE **MUST BE ALWAYS IN POSITION "OK"**. IT MUST BE IN POSITION "NO" ONLY FOR THE CALIBRATION TEST.



7.1 SEED / FERTILISER GRAIN OF REGULAR SIZE (POSITION N)

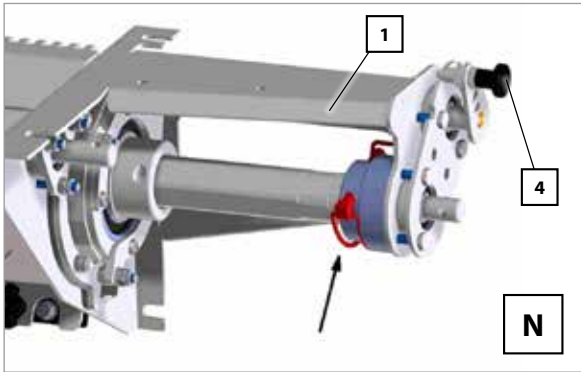

Proceed as follows to adjust the dosing for SEEDS or FERTILISER or REGULAR size:

- 1- Pull and turn the spindle (4) to adjust the graduated scale (to adjust the dose see section 11 – DOSAGE TABLES).
- 2- Place the pinions in position N (in red).
- 3- Place the clip pin of the air outlet to fan at position N.

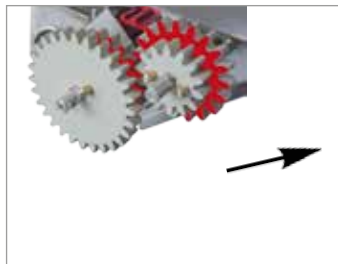

7.2 SEED / FERTILISER OF SMALL SIZE (POSITION F)



IN ORDER TO CHANGE THE PIN'S POSITION (3), IT IS ESSENTIAL THAT THE SPINDLE (4) OF THE METERING BOX CAN TURN FREELY AND THE HOPPER IS EMPTY.

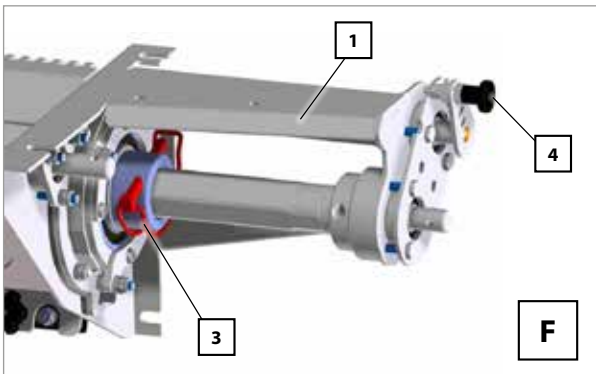

Proceed as follows to adjust the dosing for SEEDS or FERTILISER or SMALL size:

- 1- Turn the spindle (4) until it reaches position 0 on the graduated scale (1).
- 2- Remove the clip pin (3) and place it in position MICRO (F).
- 3- Turn the spindle (4) to adjust the graduated scale between 0 and 30 (to adjust the dose, see section 11- DOSAGE TABLES) .
- 4- Place the pinions in position N (in red).
- 5- Configure the ELECTRONICAL CONTROLLER (see section 9. ELECTRONICAL CONTROLLER, working in micro mode).

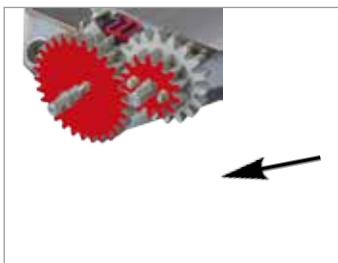

THE AIM OF MICRODOSING IS TO BETTER DISTRIBUTE FINE SEEDS, OR REGULAR SEEDS IN SMALL NUMBERS.

CHECK THE CLEANING BRUSH IS IN GOOD CONDITION BEFORE STARTING WORK.



WHEN MICRODOSING FINE SEEDS, DO NOT EXCEED NUMBER 30 ON THE GRADUATED SCALE (2) (SEE SECTION 11. DOSAGE TABLES).



7.3 CALIBRATION TEST



TO PERFORM THE PREVIOUS FLOW TEST IT IS ESSENTIAL THAT BOTH THE MACHINE AND THE TRACTOR ARE SWITCHED OFF, AND THAT BOTH THE PTO-SHAFT AND/OR THE HYDRAULIC CONNECTIONS ARE UNPLUGGED

To perform the test in it is necessary to perform some previous operations:

- 1- FILL THE HOPPER with seeds or fertiliser..
- 2- COUPLE the machine to the tractor in a SLIGHTLY RAISED position.
- 3- UNLOCK the 2 LOCKS that secure the lower lid of the venturi injector sluice so that the lid can be opened.
- 4- Place the handle of the venturi injector sluice in position NO (for calibration tests).
- 5- Place the provided sack or a container under the exit of the venturi injector sluice (under the hopper's lower protective part).
- 6- Next, turn the transmission starwheel clockwise using the hand. The number of turns to be performed depends on whether the machine is working with seeds or with fertiliser.



TABLE FOR SOWING EQUIPMENT

WORKING WIDTH (cm)	NUMBER OF STARWHEEL TURNS
	300
350	36,1
400	31,6
450	28,1
500	25,3
600	21,1
800	15,8



IMPORTANT: WHEN THE CALIBRATION TEST IS OVER, PLACE THE HANDLE OF THE VENTURI INJECTOR SLUICE BACK TO POSITION "OK".

TABLE FOR FERTILISER SPREADING EQUIPMENT

NUMBER OF STARWHEEL TURNS		ROW NUMBER							
		6	7	8	9	10	11	12	13
ROW SPACING	40	52,6	45,1	39,5	35,1	31,6	28,7	26,3	24,3
	45	46,8	40,1	35,1	31,2	28,1	25,5	23,4	21,6
	50	42,1	36,1	31,6	28,1	25,3	23,0	21,1	19,4
	55	38,3	32,8	28,7	25,5	23,0	20,9	19,1	17,7
	60	35,1	30,1	26,3	23,4	21,1	19,1	17,5	16,2
	65	32,4	27,8	24,3	21,6	19,4	17,7	16,2	14,9
	70	30,1	25,8	22,6	20,0	18,0	16,4	15,0	13,9
	75	28,1	24,1	21,1	18,7	16,8	15,3	14,0	13,0
	80	26,3	22,6	19,7	17,5	15,8	14,4	13,2	12,1
	85	24,8	21,2	18,6	16,5	14,9	13,5	12,4	11,4
	90	23,4	20,0	17,5	15,6	14,0	12,8	11,7	10,8
	95	22,2	19,0	16,6	14,8	13,3	12,1	11,1	10,2

6- Accurately weigh the collected seeds or fertiliser grains.

7- At a selected opening, you can obtain the kilograms per hectare distributed by the machine, **by MULTIPLYING the weight by 40.**



YOU MUST TURN THE STARWHEEL UNIFORMLY USING THE CRANK AT APPROXIMATELY ONE REVOLUTION PER SECOND.



THE NUMBER OF STARWHEEL DEPENDS ON THE LAND'S CHARACTERISTICS. THEREFORE IT IS HIGHLY RECOMMENDED TO PERFORM A FIELD TEST AS DESCRIBED IN SECTION 7.4.1 - TEST TO DETERMINE THE NUMBER OF STARWHEEL TURNS.



IF SEEDS SHOW EXCESS TREATMENT POWDER, FLOW CAN BE REDUCED, CONSEQUENTLY A SECOND CONTROL IS RECOMMENDED AFTER SOWING APPROXIMATELY THREE HOPPERS.

7.4 COMPLEMENTARY DOSING TESTS

7.4.1 Test to determine the NUMBER OF STARWHEEL TURNS.

If differences exist between the test and the actual dose distribution (due to a very uneven or light soil, low pressurised tyres, etc.), an experimental test can be performed.

- 1- First of all, the distance (in metres) as shown in the table below should be marked on the field's ground using a tape measure:



TABLE FOR SOWING EQUIPMENT

WORKING WIDTH (cm)	METRES TO COVER
	83,3
350	71,4
400	62,5
450	55,6
500	50,0
600	41,7
800	31,3

TABLE FOR FERTILISER SPREADING EQUIPMENT

METERS		ROW NUMBER							
		6	7	8	9	10	11	12	13
ROW SPACING	40	104,2	89,3	78,1	69,4	62,5	56,8	52,1	48,1
	45	92,6	79,4	69,4	61,7	55,6	50,5	46,3	42,7
	50	83,3	71,4	62,5	55,6	50,0	45,5	41,7	38,5
	55	75,8	64,9	56,8	50,5	45,5	41,3	37,9	35,0
	60	69,4	59,5	52,1	46,3	41,7	37,9	34,7	32,1
	65	64,1	54,9	48,1	42,7	38,5	35,0	32,1	29,6
	70	59,5	51,0	44,6	39,7	35,7	32,5	29,8	27,5
	75	55,6	47,6	41,7	37,0	33,3	30,3	27,8	25,6
	80	52,1	44,6	39,1	34,7	31,3	28,4	26,0	24,0
	85	49,0	42,0	36,8	32,7	29,4	26,7	24,5	22,6
	90	46,3	39,7	34,7	30,9	27,8	25,3	23,1	21,4
	95	43,9	37,6	32,9	29,2	26,3	23,9	21,9	20,2

2- By means of a mark made previously on the starwheel, count the number of turns performed in the covered distance.

3- Next, cover that distance with the front hopper in working position (with the transmission starwheel in contact with the ground).

By following these steps we can obtain the actual number of turns performed in the seed dosing test.

By performing the test (section 7.3 CALIBRATION TEST) using this obtained number of turns, we know the actual kilograms per hectare that will be distributed by the machine.

7.4.2 SEED DOSING ADJUSTMENTS

When using high quality certified seeds it is not enough to know the weight in kilograms distributed by the machine, as the final result of the harvest will depend on the number of plants which eventually ripen.

Every plant requires a certain amount of land from which nutrients will be absorbed. Therefore, both a low or an excessive plant density can be detrimental. To determine how many kilograms per hectare are to be sown, you should know the number of plants per square metre that are going to be planted.

As a guidance, the recommended number of plants per square metre when sowing wheat or barley in un-irrigated land can be found in following table:

OTOÑO	PRIMAVERA
Siembra precoz, 200 plantas por m²	Siembra precoz, 310 plantas por m ²
Siembra tardía, 265 plantas por m²	Siembra tardía, 445 plantas por m ²

Please note that in spring there is less tillering so more seeds should be sown.



MAQUINARIA AGRÍCOLA SOLÀ, S.L., RECOMMENDS THAT THE FARMER SEEKS PROFESSIONAL ADVICE ABOUT THIS SUBJECT FROM A TECHNICAL SOWING CENTRE



SEED DOSING SHOULD BE ADJUSTED TO EACH TERRAIN, DEPENDING ON THE: TEXTURE, FERTILIZING LEVEL, PLUVIOMETER RESULTS AND SOWING SEASON, GRAIN QUALITY, GERMINATING AND TILLERING POWER, ETC.

It should be taken into account that a seed's germinating power is variable and dependant on multiple factors. It can be experimentally calculated to be between 70% and 80%, which is practically equivalent to multiplying the number of grains to be sown by 1,43 or 1,25 respectively.

DOSAGE

Next, we describe a practical method to determine the number of kilos per hectare to be distributed once we know how many plants per square metre we want to obtain.

1- Insert the "seed counter" into the seed sack to fill it.

2- When taking the "seed counter" out, wipe the seed counter with your hand to make sure that there is only one grain per slot (100 grains in total).

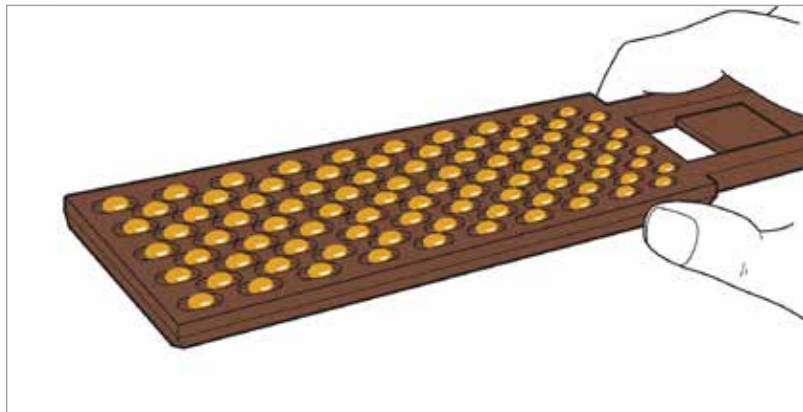

3- Do the same 10 times to obtain 1000 grains.

4- Weigh these 1000 grains with the precision scales.

We call the result the OPERATIVE WEIGHT.

Once we know how many seeds per square metre we are going to sow, we should adjust the following kilograms per hectare in the dosing control:

$$\text{KILOGRAMS PER HECTARE} = (\text{grains per m}^2 \times \text{OPERATIVE WEIGHT}) / 100$$

7.4.3 FERTILISER DOSING ADJUSTMENTS

Due to the wide range of fertilisers available on the market, it is recommended to perform a calibration test using the desired dose of fertiliser to be applied on the ground. To perform it, follow these steps:

- 1- In the dosing system, adjust the outlet opening to the desired dose to be applied on the ground. Use the tables in section 11 - DOSAGE TABLES.
- 2- Perform a calibration test (see section 7.3 – CALIBRATION TEST).
- 3- Perform the test to determine the number of wheel turns (section 7.4.1 - TEST TO DETERMINE THE NUMBER OF STARWHEEL TURNS).
- 4- Check that the number of wheel turns calculated in step 2 is similar to the number of wheel turns obtained in step 3. If both tests show different results, the dose should be adjusted using the following formula:

$$B = \frac{A}{C} \cdot D$$

Where: B = posición ajustada del dosificador.

A = Kg/Ha of fertiliser to be applied on the ground (this value needs to match some value shown in the table of section 11 – DOSAGE TABLE).

D = Kg/Ha of fertiliser that the machine actually applies on the ground (see 7.4.1 - TEST TO DETERMINE THE NUMBER OF WHEEL TURNS)

C = Position of the metering box depending on the value in Kg/Ha indicated in the dosage table. This value depends on the value «**A**».

DOSAGE

8. TYPES OF DISTRIBUTION

8.1 FERTILISER DISTRIBUTION BY MECHANICAL FAN



To ensure that seeds or fertiliser are supplied to the coupled seed drill, it is essential that the fan speed is between 4200 and 4500 rpm. For this purpose, the PTO shaft must be plugged into the 1000 rpm vent.



If the turning speed is lower then some seeds are likely to remain in the seed hoses.



Before the transmission starwheel starts turning, please ensure that the fan's turning speed is between 4200 and 4500. When raising the machine, never decrease the fan's turning speed until the wheel is detached from the ground and stops turning.



Please note that if you work with the front hopper while the fan is off and the transmission starwheel is in contact with the ground, seeds will block the collecting pipe of the venturi injector sluice. In case this happens, the collector should be taken out and emptied before using the machine again.



IF THE FAN'S TURNING SPEED IS ABOVE OR BELOW 4200 AND 4500 RPM, THEN TURNING THE TRANSMISSION STARWHEEL CAN CAUSE A BLOCKAGE INSIDE THE SEED HOSES.

8.2 SEED DISTRIBUTION BY HYDRAULIC FAN

SOWING OR FERTILISER EQUIPMENT WIDTH	Hydraulic motor			Oil supply	
	Absorbing capacity (cm ³)	Speed (rpm)	Minimum output pressure (bars)	Presión máx. retorno (bares)	Caudal de aceite (L/mín)
400 a 450	8	4200	130	1,5	36
500 a 600	8	4500	160	1,5	40

CONNECTIONS

Connect the fan's small hydraulic hose line to a pressurised tractor control unit. The fan's 1/2" hydraulic hose line should be connected to a depressurised return tractor control unit.



IN THE RETURN LINE THE PRESSURE MUST BE A MAXIMUM OF 1,5 BAR. A HIGHER PRESSURE CAN CAUSE DAMAGE TO THE TRACTOR'S MOTOR.

ADJUSTMENT

The fan's rpm is adjusted by regulating the tractor control unit.

The fan's turning speed must be adjusted to 4200 rpm or to 4500 rpm as shown in table above.



IF OIL IS OVERHEATED DUE TO AN EXCESSIVE FLOW OR DUE TO LOW OIL SUPPLY, THEN A REFRIGERATING SYSTEM FOR THE FAN WILL BE REQUIRED.



IF THE FLOW OF THE TRACTOR'S HYDRAULIC PUMP IS NOT HIGH ENOUGH IT WILL NOT BE ABLE TO POWER THE FAN'S MOTOR OR ACTIVATE THE OTHER ELEMENTS REQUIRED. IN THIS CASE AUXILIARY EQUIPMENT CONSISTING OF A HYDRAULIC PUMP FITTED ON THE TRACTOR'S PTO-SHAFT AND FIXED TO IT. MOREOVER, A REFRIGERATED OIL TANK WILL BE REQUIRED. ASK THE MANUFACTURER

9. NEUMASEM ELECTRICAL CONTROLLER

9.1 FRONT PANEL DESCRIPTION

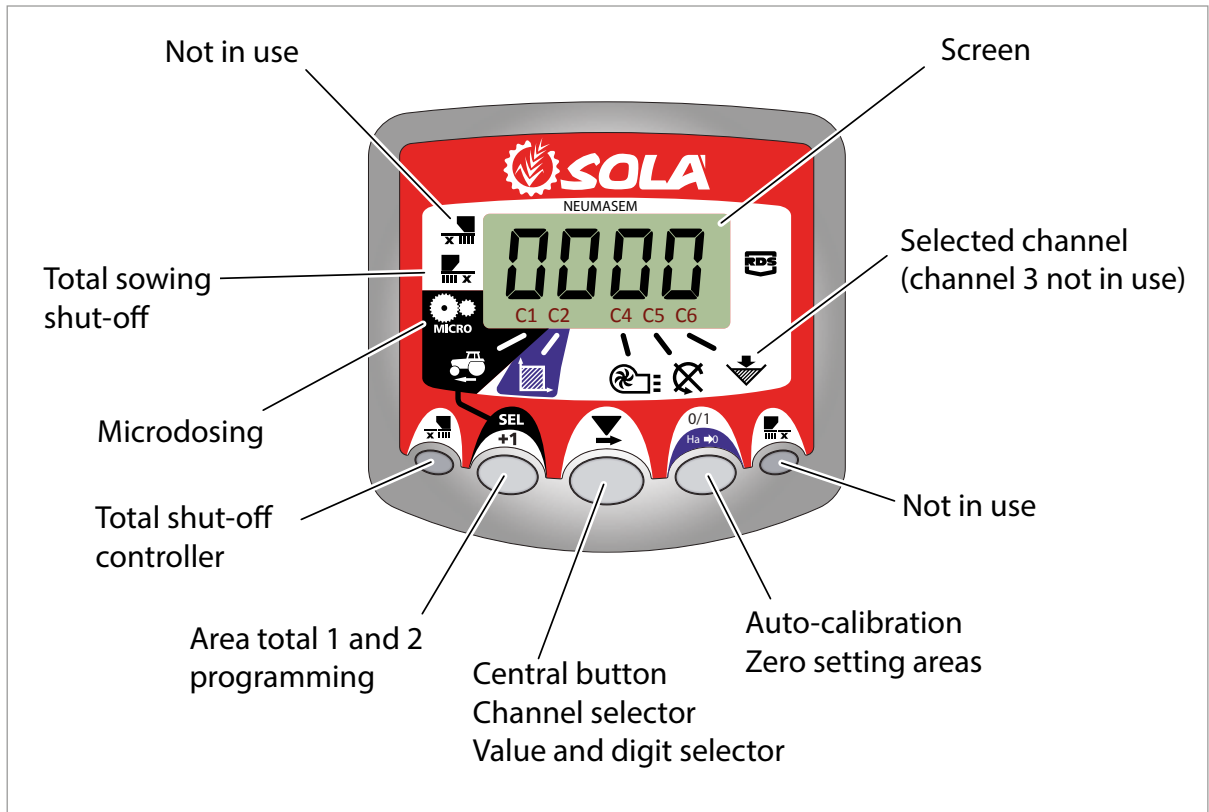

The monitor provided comes programmed especially for your model of front hopper. The user will only need to observe the displayed values and no extra programming is required.

The monitor shows 6 different channels or readings, as well as 3 different arrows showing the states.

C1 shows forward speed in m/sec.

C2 shows two different hectares (for example one partial and one total hectare).

C3 not in use.

C4 shows the fan's rpm.

C5 shows the turning speed of the metering box's axle in rpm.

C6 shows if the hopper's seed level is too low.

By default the forward movement speed is displayed on the monitor. When some abnormal readings are shown, the screen will display “**ALAR**” intermittently, the alarm will sound and the corresponding malfunction channel will be activated. The alarm will not stop until the malfunction is fixed.

To display a desired reading, press the central button and scroll to the required channel. After 10 seconds, the reading will change back to C1 again.

9.2 FORWARD SPEED – C1



Select a channel by using the central button. The alarm is activated when the speed is under 2.6 km/h and can be turned off using programming mode 2.

Calibrating the speed sensor

Theoretical calibration is achieved by entering a calibration factor in programming mode 2, as indicated in the following table.

WORKING WIDTH	4M	4,5M	5M	6M
CALIBRATION FACTOR	1,979	1,979	1,979	1,979

Selecting speed channel (C1)

1- Press  to switch to mode 1. While holding the button, press the central  para cambiar el dígito a modificar.

2- Hold the central button for some seconds to modify the flickering digit.

3- When the buttons are released, the monitor will return to its normal state.



PLEASE NOTE:

THE IMPULSE NUMBER AUTO-CALIBRATION MODE IS MORE ACCURATE AND A FIELD TEST PERFORMANCE IS REQUIRED.

Auto-calibrating the speed sensor

1- Mark 100 metres

2- Select channel 1 (speed).

3- Press  and hold it while pressing 
The screen will display "Auto". Release it.

4- Cover the 100 marked metres. The monitor will count the sensor's impulses.

5- After finishing, press  again.

By doing this, the monitor retains the impulse number in the memory.

9.3 TOTAL AREA / WORKING WIDTH – C2

Two independent total areas can be marked.

Displaying the total area

1- Select channel 2.

2- Press  to display total areas 1 and 2 on the screen «tot.1» and «tot.2».
First, «tot.1» will be displayed and immediately afterwards the value in Ha will be shown.

Setting to zero the total areas

1- Select channel 2.

2- Press  to display.

3- Press and hold  for more than 5 seconds.

Programming the working width

1- Select channel 2 of the area.

2- Press and hold  for more than 5 seconds until the width value is displayed and, without releasing it, press the central button to modify the flickering digit.

3- Press and hold the flickering digit for more than 3 seconds to modify its value.

4- Release all buttons to return to the normal state.

Working in micro mode

In order to work with the metering box in the micro-dosing mode (for small hoppers and minimal doses):

Press and hold  button for more than 3 seconds until the arrow indicating the micro mode is displayed. In this situation, the monitor will keep the speed and actual real working area.

Press and hold  for more than 5 seconds until the indicating arrow disappears to resume normal position.

9.4 FAN RPM / FAN ALARMS – C4



To display the fan's speed in rpm

Select channel 4 using the central button .

Fan alarms

The fan's minimum turning speed can be programmed. Under 2 Km/h these alarms will deactivate.



Fan’s minimum speed

- 1- Select channel 4.
- 2- Press and hold  button for more than 5 seconds.
- 3- Press  to change value and digits as explained in former cases. Default speed is 3800 rpm.
- 4- Release all buttons to resume the normal position.

Selecting the fan’s number of impulses per revolution (default value is set to 2).

PLEASE NOTE

FAN’S NUMBER OF IMPULSES PER REVOLUTION SHOULD ALWAYS BE 2. ONLY USE THIS PROGRAMMING MODE IN CASE OF MALFUNCTION.

- 1- TO SELECT PROGRAMMING MODE 2, PRESS  BUTTON WHILE SWITCHING ON THE SCREEN USING REAR SWITCH.
- 2- PRESS  TO CHANGE THE CHANNEL AND SELECT CHANNEL 4 (FAN).
- 3- PRESS AND HOLD  PTO MODIFY THE FLICKERING DIGIT (IT SHOULD ALWAYS BE 2).
- 4- RELEASE THE BUTTON TO CHANGE BACK TO NORMAL POSITION.

9.5 METERING BOX’S SHAFT RPM – C5

Select channel 5 using the central button .

40 seconds after the seed shaft stops turning, an alarm beeps 5 times consecutively. If it remains still, this alarm will repeat every 30 seconds.



To turn off the beeping, switch off the screen and switch it on again. This alarm will deactivate under 2 Km/h.

The seed shaft’s alarm can be deactivated by pressing the button  for more than 5 seconds on the selected channel. The screen will display “Off”. In this situation the alarm will not be activated even if the screen is switched off and on again.

9.6 HOPPER LOW LEVEL ALARM – C6

When the seed level is below the sensor, an alarm is activated and beeps 5 times consecutively. In this case the screen will display «**ALAR**».

Activate and deactivate hopper level alarm

- 1- Select channel 6 using the central button .
- 2- Press and hold  button and...
- 3- Press the central button  to select "0" (alarm is off) or "1" (alarm is on).
- 4- Release the buttons to change back to the normal position.

10. MAINTENANCE



IN CASE OF MALFUNCTION, STOP THE FRONT HOPPER IMMEDIATELY AND REMOVE THE IGNITION KEY. LEAVE THE TRACTOR AND VISUALLY INSPECT AND EVALUATE THE EXTENT OF THE PROBLEM. PERFORM THE REQUIRED OPERATIONS ON THE FRONT HOPPER BEFORE RESTARTING IT.



MAINTENANCE OPERATIONS MUST BE PERFORMED IN PROPERLY EQUIPPED GARAGES BY QUALIFIED PERSONNEL



NO REPAIRS SHOULD BE PERFORMED WITHOUT THE NECESSARY SKILLS AND KNOWLEDGE. IT IS ESSENTIAL THAT THE INSTRUCTIONS DETAILED IN THIS MANUAL ARE STRICTLY FOLLOWED. IF THESE INSTRUCTIONS ARE MISSING, PLEASE CONTACT THE FRONT HOPPER'S PROVIDER OR QUALIFIED PERSONNEL.



IN ORDER TO PERFORM MAINTENANCE OR REPAIR OPERATIONS TO THE FRONT HOPPER, IT IS ESSENTIAL TO USE PROPER PERSONAL PROTECTIVE EQUIPMENT (PPE): SAFETY BOOTS AND GLOVES, HEARING PROTECTION, DUST MASK AND PROTECTIVE GLASSES).



IT IS RECOMMENDED TO AVOID WEARING LOOSE CLOTHING SINCE IT MAY BECOME TANGLED WITH THE MACHINE'S MOVING PARTS.



Before performing any task on the machine, it is essential to take into account the following factors:



MAINTAINING OR REPAIRING THE FRONT HOPPER SHOULD BE PERFORMED ON A FLAT AND COMPACT GROUND. BEFORE STARTING ANY OF THESE TASKS, THE TRACTOR'S ENGINE MUST BE TURNED OFF AND THE IGNITION KEY REMOVED.



THE CHOSEN DEVICE TO RAISE THE FRONT HOPPER NEEDS TO BE APPROPRIATE FOR THE OPERATIONS TO BE PERFORMED. PLEASE ENSURE THAT ALL SAFETY REGULATIONS ARE OBSERVED.



ALWAYS USE APPROPRIATE PROTECTIVE EQUIPMENT FOR ANY TASK TO BE PERFORMED.



IN CASE COMPRESSED AIR IS USED TO CLEAN THE FRONT HOPPER, OR AN AIR-BRUSH IS USED TO PAINT ANY FRONT HOPPER'S PART, YOU ARE REQUIRED TO WEAR PROTECTIVE GLASSES AND MASK.



IF ANY OPERATION NEEDS TO BE PERFORMED ON A PART OF THE MACHINE WHICH IS AT MORE THAN 1,5 METRES HEIGHT FROM THE GROUND, CHECK IF IT IS POSSIBLE TO REACH THIS PART USING THE FRONT HOPPER'S ACCESS POINTS (FRONT HOPPER'S ACCESS PLATFORM). IF NOT POSSIBLE, USE EITHER A LADDER OR A PLATFORM WHICH IS IN ACCORDANCE WITH THE CURRENT SAFETY REGULATIONS.



PROLONGED AND/OR REPETITIVE SKIN CONTACT WITH FUEL AND LUBRICANTS IS HARMFUL. IN CASE THESE PRODUCTS COME ACCIDENTALLY INTO CONTACT WITH THE EYES OR OTHER SENSITIVE PARTS, WASH WELL THE AFFECTED PARTS WITH CLEAN WATER. IN CASE OF INGESTION, CONTACT THE MEDICAL SERVICES IMMEDIATELY.

10.1 CHECKING FREQUENCY

The frequency of the checks indicated below is provided as a guideline. It may vary depending on machine application and use, environment, temperature, weather conditions, etc.

BEFORE STARTING THE SOWING SEASON:

- Check the general operation of the machine. Perform this check without any seeds or fertiliser inside the hopper.
- Check that the plastic components of the machine are in good condition. The wear of this material due to natural ageing or to the presence of rodents causes damages to these components.
- Clean the parts of the machine which are permanently in contact with seeds, such as the hopper, metering box and ducts.

PERIODICALLY

- Before washing the front hopper with water, check that no seeds or fertiliser are inside the hopper, the metering box or the ducts.
- When the front hopper is used with fertiliser, wash well with water all parts which are in contact with the fertiliser once the work is over. These chemical products are corrosive and a prolonged contact could damage some parts of the machine. Empty the hopper after every working day. Otherwise, moisture may compact the remaining fertiliser and the moving parts would be blocked.
- Check that all the screws are in good condition, especially the ones which are in contact with the ground. Tighten every single screw and bolt.
- Check that the metering box does not contain any residue (such as seed or fertiliser residue, dust, etc). Residue accumulation may damage this part.
- Always keep the hydraulic connections in good condition. The pressure of the hydraulic circuit may cause serious damage to persons. Pressure losses in the hydraulic circuit will result in a lack of seeds in the seed disc.

PERIOD OF INACTIVITY / END OF SOWING SEASON

- Wash the front hopper well with a lot of water, making sure that no seeds, fertiliser or other products remain inside the hoppers, metering boxes or ducts.
- Properly lubricate the moving parts of the front hopper (see section 10.2 GREASING AND LUBRICATION).
- To store the front hopper properly, cover it with tarpaulin and keep it in a dry place.
- Thoroughly check all components of the front hopper and replace the ones which are damaged or worn.

10.2 GREASING AND LUBRICATION

Every non-painted metallic component of the front hopper is exposed to atmospheric and weather conditions, which may oxidize them. For this reason, it is important to grease and lubricate these components.

Attached to specific parts of the front hopper, you will find adhesives with symbols to indicate the parts to be GREASED (A) or the points to be LUBRICATED (B).

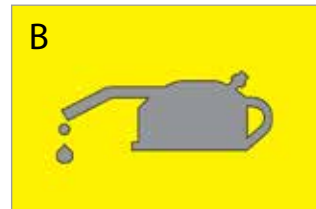
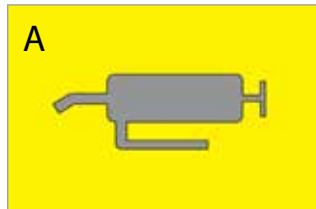

BEFORE LUBRICATING OR GREASING, WASH THE FRONT HOPPER TO REMOVE EARTH RESIDUES ATTACHED TO THE MACHINE (see section 10.1 CHECKING FREQUENCY).

The following parts of the front hopper should be greased:

- Each component of the transmission.
- Each joint of the PTOs and cardan transmissions.



To GREASE THESE PARTS, always use SOLID CALCIUM GREASE.



SOME PARTS OF THE FRONT HOPPER NEED TO BE GREASED EVERY 50 WORKING HOURS. NOT OBSERVING THESE GREASING RULES MAY RESULT IN DAMAGE TO THE MACHINE.

10.3 FANS

Keep the air outlets free.



Before starting the sowing season, check that the ducts of the air circuit are in good condition.

In machine versions equipped with hydraulic fan, always keep the hydraulic connections in good condition. The pressure of the hydraulic circuit may cause serious damage to persons.

Pressure losses in the hydraulic circuit will result in a lower fan speed. Consequently the air flow will decrease and the circuit will be blocked.

Prevent blockages in the metallic filter which filters the air from the fan. Periodically check its condition. In order to clean it, use compressed air to blow or, if necessary, proceed to disassemble it to better perform the operation.

10.4 FRONT HOPPER CLEANING

Front hopper must be well washed using running water or, preferably using a high-pressure cleaner. In order to prevent the mechanical parts from rust, let the machine dry before proceeding to grease and lubricate it.



WHEN THE FRONT HOPPER IS USED WITH FERTILISER, WASH WELL WITH WATER ALL PARTS WHICH ARE IN CONTACT WITH THE FERTILISER ONCE THE WORK IS OVER. THESE CHEMICAL PRODUCTS ARE CORROSIVE AND A PROLONGED CONTACT COULD DAMAGE SOME PARTS OF THE MACHINE.

After washing the machine, turn on the fan for some minutes in order to remove the moisture from the air circuit.



EVERY TIME THE SEED HOPPER IS CLEANED USING COMPRESSED AIR, USE PROPER PERSONAL PROTECTIVE EQUIPMENT (PPE) (see section 10- MAINTENANCE).

11. DOSAGE TABLES



INDICATED QUANTITIES SHOWN IN THE FOLLOWING TABLES SHOULD BE CONSIDERED FOR GUIDANCE ONLY, FORESEEN FLOWS CAN VARY DEPENDING ON THE ACCIDENTAL PRESENCE OF DISINFECTING PRODUCTS, UNEVEN SEED SIZE, FERTILISER'S GRANULOMETRY, DENSITY, SPECIFIC WEIGHT, HUMIDITY, ETC.



FOR PRECISION SOWING OR FERTILISING, FOLLOW DOSING PROCESS DESCRIBED IN SECTION 6 OF THIS MANUAL.

11.1 SEED MICRODOSING

Seed dosage tables are in Kg/Ha, which will be distributed by the machine depending on both the working width and the selected position on the dosing graduated scale.

WORKING WIDTH 3M SMALL SIZE	Rape		Red Clover		Grass		Turnip	
	0,65	0,77	0,39	0,7	SMALL SEED (Kg/Ha) – ADJUSTING POSITION F			
Specific weight (Kg/l)								
Position on the graduated scale								
2,5	1,7	0,87	2,1	1,03	-	-	1,9	0,93
5	3,5	1,73	4,1	2,05	-	-	3,7	1,87
7,5	5,2	2,60	6,2	3,08	3,1	1,56	5,6	2,80
10	6,9	3,47	8,2	4,11	4,2	2,08	7,5	3,74
12,5	7,9	3,95	9,4	4,68	4,7	2,37	8,5	4,26
15	9,5	4,75	11,2	5,62	5,7	2,85	10,2	5,11
17,5	11,1	5,54	13,1	6,56	6,6	3,32	11,9	5,96
20	12,7	6,33	15,0	7,50	7,6	3,80	13,6	6,81
22,5	15,2	7,60	18,0	9,01	9,1	4,56	16,4	8,19
25	16,9	8,45	20,0	10,01	10,1	5,07	18,2	9,10
27,5	18,6	9,29	22,0	11,01	11,2	5,58	20,0	10,01
30	20,3	10,14	24,0	12,01	12,2	6,08	21,8	10,92
	N	F	N	F	N	F	N	F

N = pinions in regular position

F = pinions in microdosing position

WORKING WIDTH 3,5M SMALL SIZE	Rape		Red Clover		Grass		Turnip	
	0,65		0,77		0,39		0,7	
Specific weight (Kg/l)	SMALL SEED (Kg/Ha) – ADJUSTING POSITION F							
Position on the graduated scale	SMALL SEED (Kg/Ha) – ADJUSTING POSITION F							
2,5	1,5	0,74	1,8	0,88	-	-	1,6	0,80
5	3,0	1,49	3,5	1,76	-	-	3,2	1,60
7,5	4,5	2,23	5,3	2,64	2,7	1,34	4,8	2,40
10	5,9	2,97	7,0	3,52	3,6	1,78	6,4	3,20
12,5	6,8	3,39	8,0	4,02	4,1	2,03	7,3	3,65
15	8,1	4,07	9,6	4,82	4,9	2,44	8,8	4,38
17,5	9,5	4,75	11,2	5,62	5,7	2,85	10,2	5,11
20	10,8	5,42	12,8	6,42	6,5	3,25	11,7	5,84
22,5	13,0	6,52	15,4	7,72	7,8	3,91	14,0	7,02
25	14,5	7,24	17,2	8,58	8,7	4,35	15,6	7,80
27,5	15,9	7,97	18,9	9,44	9,6	4,78	17,2	8,58
30	17,4	8,69	20,6	10,30	10,4	5,21	18,7	9,36
	N	F	N	F	N	F	N	F

WORKING WIDTH 4M SMALL SIZE	Rape		Red Clover		Grass		Turnip	
	0,65		0,77		0,39		0,7	
Specific weight (Kg/l)	SMALL SEED (Kg/Ha) – ADJUSTING POSITION F							
Position on the graduated scale	SMALL SEED (Kg/Ha) – ADJUSTING POSITION F							
2,5	1,3	0,65	1,5	0,77	-	-	1,4	0,70
5	2,6	1,30	3,1	1,54	-	-	2,8	1,40
7,5	3,9	1,95	4,6	2,31	2,3	1,17	4,2	2,10
10	5,2	2,60	6,2	3,08	3,1	1,56	5,6	2,80
12,5	5,9	2,97	7,0	3,51	3,6	1,78	6,4	3,19
15	7,1	3,56	8,4	4,22	4,3	2,14	7,7	3,83
17,5	8,3	4,15	9,8	4,92	5,0	2,49	8,9	4,47
20	9,5	4,75	11,2	5,62	5,7	2,85	10,2	5,11
22,5	11,4	5,70	13,5	6,76	6,8	3,42	12,3	6,14
25	12,7	6,34	15,0	7,51	7,6	3,80	13,6	6,82
27,5	13,9	6,97	16,5	8,26	8,4	4,18	15,0	7,51
30	15,2	7,60	18,0	9,01	9,1	4,56	16,4	8,19
	N	F	N	F	N	F	N	F

DOSAGE TABLES

WORKING WIDTH 4,5M SMALL SIZE	Rape		Red Clover		Grass		Turnip	
	0,65		0,77		0,39		0,7	
Specific weight (Kg/l)	SMALL SEED (Kg/Ha) – ADJUSTING POSITION F							
Position on the graduated scale	SMALL SEED (Kg/Ha) – ADJUSTING POSITION F							
2,5	1,2	0,58	1,4	0,68	-	-	1,2	0,62
5	2,3	1,16	2,7	1,37	-	-	2,5	1,25
7,5	3,5	1,73	4,1	2,05	2,1	1,04	3,7	1,87
10	4,6	2,31	5,5	2,74	2,8	1,39	5,0	2,49
12,5	5,3	2,64	6,2	3,12	3,2	1,58	5,7	2,84
15	6,3	3,16	7,5	3,75	3,8	1,90	6,8	3,41
17,5	7,4	3,69	8,7	4,37	4,4	2,21	7,9	3,97
20	8,4	4,22	10,0	5,00	5,1	2,53	9,1	4,54
22,5	10,1	5,07	12,0	6,01	6,1	3,04	10,9	5,46
25	11,3	5,63	13,3	6,67	6,8	3,38	12,1	6,07
27,5	12,4	6,20	14,7	7,34	7,4	3,72	13,3	6,67
30	13,5	6,76	16,0	8,01	8,1	4,06	14,6	7,28
	N	F	N	F	N	F	N	F

WORKING WIDTH 5M SMALL SIZE	Rape		Red Clover		Grass		Turnip	
	0,65		0,77		0,39		0,7	
Specific weight (Kg/l)	SMALL SEED (Kg/Ha) – ADJUSTING POSITION F							
Position on the graduated scale	SMALL SEED (Kg/Ha) – ADJUSTING POSITION F							
2,5	1,0	0,52	1,2	0,62	-	-	1,1	0,56
5	2,1	1,04	2,5	1,23	-	-	2,2	1,12
7,5	3,1	1,56	3,7	1,85	1,9	0,94	3,4	1,68
10	4,2	2,08	4,9	2,47	2,5	1,25	4,5	2,24
12,5	4,7	2,37	5,6	2,81	2,8	1,42	5,1	2,56
15	5,7	2,85	6,7	3,37	3,4	1,71	6,1	3,07
17,5	6,6	3,32	7,9	3,94	4,0	1,99	7,2	3,58
20	7,6	3,80	9,0	4,50	4,6	2,28	8,2	4,09
22,5	9,1	4,56	10,8	5,40	5,5	2,74	9,8	4,91
25	10,1	5,07	12,0	6,01	6,1	3,04	10,9	5,46
27,5	11,2	5,58	13,2	6,61	6,7	3,35	12,0	6,01
30	12,2	6,08	14,4	7,21	7,3	3,65	13,1	6,55
	N	F	N	F	N	F	N	F

WORKING WIDTH 6M SMALL SIZE	Rape		Red Clover		Grass		Turnip	
	0,65		0,77		0,39		0,7	
Specific weight (Kg/l)	SMALL SEED (Kg/Ha) – ADJUSTING POSITION F							
Position on the graduated scale	SMALL SEED (Kg/Ha) – ADJUSTING POSITION F							
2,5	0,9	0,43	1,0	0,51	-	-	0,9	0,47
5	1,7	0,87	2,1	1,03	-	-	1,9	0,93
7,5	2,6	1,30	3,1	1,54	1,6	0,78	2,8	1,40
10	3,5	1,73	4,1	2,05	2,1	1,04	3,7	1,87
12,5	4,0	1,98	4,7	2,34	2,4	1,19	4,3	2,13
15	4,7	2,37	5,6	2,81	2,8	1,42	5,1	2,56
17,5	5,5	2,77	6,6	3,28	3,3	1,66	6,0	2,98
20	6,3	3,16	7,5	3,75	3,8	1,90	6,8	3,41
22,5	7,6	3,80	9,0	4,50	4,6	2,28	8,2	4,09
25	8,4	4,22	10,0	5,00	5,1	2,53	9,1	4,55
27,5	9,3	4,65	11,0	5,51	5,6	2,79	10,0	5,00
30	10,1	5,07	12,0	6,01	6,1	3,04	10,9	5,46
	N	F	N	F	N	F	N	F

WORKING WIDTH 8M SMALL SIZE	Rape		Red Clover		Grass		Turnip	
	0,65		0,77		0,39		0,7	
Specific weight (Kg/l)	SMALL SEED (Kg/Ha) – ADJUSTING POSITION F							
Position on the graduated scale	SMALL SEED (Kg/Ha) – ADJUSTING POSITION F							
2,5	0,7	0,33	0,8	0,39	-	-	0,7	0,35
5	1,3	0,65	1,5	0,77	-	-	1,4	0,70
7,5	2,0	0,98	2,3	1,16	1,2	0,59	2,1	1,05
10	2,6	1,30	3,1	1,54	1,6	0,78	2,8	1,40
12,5	3,0	1,48	3,5	1,76	1,8	0,89	3,2	1,60
15	3,6	1,78	4,2	2,11	2,1	1,07	3,8	1,92
17,5	4,2	2,08	4,9	2,46	2,5	1,25	4,5	2,24
20	4,7	2,37	5,6	2,81	2,8	1,42	5,1	2,56
22,5	5,7	2,85	6,8	3,38	3,4	1,71	6,1	3,07
25	6,3	3,17	7,5	3,75	3,8	1,90	6,8	3,41
27,5	7,0	3,49	8,3	4,13	4,2	2,09	7,5	3,75
30	7,6	3,80	9,0	4,50	4,6	2,28	8,2	4,09
	N	F	N	F	N	F	N	F

11.2 REGULAR SEEDS DOSING

Seed dosage tables are in Kg/Ha, which will be distributed by the machine depending on both the working width and the selected position on the dosing graduated scale.

WORKING WIDTH 3M REGULAR SIZE	Wheat	Rye	Barley	Oats	Beans	Peas	Lupin	Carob	Corn	Hierba
		Grass	0,68	0,5	0,85	0,81	0,76	0,83	0,79	0,36
Position on the graduated scale	REGULAR SEED (Kg/Ha) – ADJUSTING POSITION NORMAL									
10	63,5	61,0	56,0	41,2	70,0	66,7	62,6	68,4	65,1	-
15	95,2	91,5	84,1	61,8	105	100,1	93,9	103	97,6	44,5
20	127	122	112	82,4	140	133	125	137	130	59,3
25	159	152	140	103	175	167	157	171	163	74,2
30	191	184	169	124	211	201	189	206	196	89,5
35	223	215	197	145	247	235	220	241	229	104
40	255	245	225	166	282	268	252	275	262	-
45	287	276	254	186	317	302	283	310	295	-
50	319	307	282	207	352	336	315	344	327	-
55	340	327	300	221	375	358	336	367	349	-
60	371	357	328	241	409	390	366	400	381	-
65	402	386	355	261	444	423	397	433	412	-
70	433	416	382	281	478	455	427	467	444	-
75	464	446	409	301	512	488	458	500	476	-
80	491	472	433	319	542	516	484	529	504	-
85	522	501	461	339	576	549	515	562	535	-
90	552	531	488	359	610	581	545	595	567	-
95	583	560	515	379	643	613	575	628	598	-
100	614	590	542	398	677	645	606	661	630	-
105	647	622	571	420	714	681	639	697	664	-
110	678	651	599	440	748	713	669	731	695	-
115	709	681	626	460	782	745	699	764	727	-
120	739	711	653	480	816	778	730	797	759	-
125	770	740	680	500	850	810	760	830	790	-
130	801	770	707	520	884	843	791	863	822	-

WORKING WIDTH 3,5M REGULAR SIZE	Wheat	Rye	Barley	Oats	Beans	Peas	Lupin	Carob	Corn	Hierba
		Grass	0,68	0,5	0,85	0,81	0,76	0,83	0,79	0,36
Position on the graduated scale	REGULAR SEED (Kg/Ha) – ADJUSTING POSITION NORMAL									
10	54,4	52,3	48,0	35,3	60,0	57,2	53,7	58,6	55,8	-
15	81,6	78,4	72,0	53,0	90,1	85,8	80,5	87,9	83,7	
20	109	105	96,1	70,6	120	114	107	117	112	50,9
25	136	131	120	88,3	150	143	134	147	139	63,6
30	164	158	145	107	181	173	162	177	168	76,7
35	191	184	169	124	211	201	189	206	196	89,5
40	219	210	193	142	242	230	216	236	224	-
45	246	237	217	160	272	259	243	265	253	-
50	273	263	242	178	302	288	270	295	281	-
55	291	280	257	189	322	307	288	314	299	-
60	318	306	281	206	351	334	314	343	326	-
65	344	331	304	224	380	362	340	371	353	-
70	371	357	328	241	409	390	366	400	381	-
75	397	382	351	258	439	418	392	428	408	-
80	421	404	372	273	464	443	415	454	432	-
85	447	430	395	290	493	470	441	482	459	-
90	473	455	418	307	523	498	467	510	486	-
95	500	480	441	324	552	526	493	539	513	-
100	526	505	464	342	581	553	519	567	540	-
105	555	533	490	360	612	583	547	598	569	-
110	581	558	513	377	641	611	573	626	596	-
115	607	584	536	394	670	639	599	655	623	-
120	634	609	560	412	700	667	626	683	650	-
125	660	634	583	429	729	694	652	712	677	-
130	687	660	606	446	758	722	678	740	704	-

* When the dose to be planted (Kg/Ha) is very small (position on the graduated scale ≤ 10), it is possible to obtain a more uniform planting by means of microdosing, even with a regular range of seeds (cereal and big seeds).

DOSAGE TABLES

WORKING WIDTH 4M REGULAR SIZE	Wheat	Rye	Barley	Oats	Beans	Peas	Lupin	Carob	Corn	Hierba
		Grass	0,68	0,5	0,85	0,81	0,76	0,83	0,79	0,36
Specific weight (Kg/l)	REGULAR SEED (Kg/Ha) – ADJUSTING POSITION NORMAL									
Position on the graduated scale	REGULAR SEED (Kg/Ha) – ADJUSTING POSITION NORMAL									
10	47,6	45,7	42,0	30,9	52,5	50,1	47,0	51,3	48,8	-
15	71,4	68,6	63,0	46,4	78,8	75,1	70,5	76,9	73,2	
20	95,2	91,5	84,1	61,8	105	100	93,9	103	97,6	44,5
25	119	114	105	77,3	131	125	117	128	122	55,6
30	144	138	127	93,2	158	151	142	155	147	67,1
35	167	161	148	109	185	176	165	181	172	78,3
40	191	184	169	124	211	201	189	206	196	-
45	215	207	190	140	238	227	213	232	221	-
50	239	230	211	155	264	252	236	258	245	-
55	255	245	225	166	282	268	252	275	262	-
60	278	267	246	181	307	293	275	300	285	-
65	301	290	266	196	333	317	297	325	309	-
70	325	312	287	211	358	341	320	350	333	-
75	348	334	307	226	384	366	343	375	357	-
80	368	354	325	239	406	387	363	397	378	-
85	391	376	345	254	432	411	386	422	401	-
90	414	398	366	269	457	436	409	446	425	-
95	437	420	386	284	483	460	431	471	449	-
100	460	442	406	299	508	484	454	496	472	-
105	485	466	428	315	536	510	479	523	498	-
110	508	489	449	330	561	535	502	548	522	-
115	531	511	469	345	587	559	525	573	545	-
120	555	533	490	360	612	583	547	598	569	-
125	578	555	510	375	638	608	570	623	593	-
130	601	577	531	390	663	632	593	648	616	-

* When the dose to be planted (Kg/Ha) is very small (position on the graduated scale ≤ 10), it is possible to obtain a more uniform planting by means of microdosing, even with a regular range of seeds (cereal and big seeds).

WORKING WIDTH 4,5M REGULAR SIZE	Wheat	Rye	Barley	Oats	Beans	Peas	Lupin	Carob	Corn	Hierba
	Grass	0,68	0,5	0,85	0,81	0,76	0,83	0,79	0,36	
Position on the graduated scale	REGULAR SEED (Kg/Ha) – ADJUSTING POSITION NORMAL									
10	42,3	40,7	37,4	27,5	46,7	44,5	41,8	45,6	43,4	-
15	63,5	61,0	56,0	41,2	70,0	66,7	62,6	68,4	65,1	
20	84,6	81,3	74,7	54,9	93,4	89,0	83,5	91,2	86,8	39,6
25	106	102	93,4	68,7	117	111	104	114	108	49,4
30	128	123	113	82,9	141	134	126	138	131	59,7
35	149	143	131	96,7	164	157	147	160	153	69,6
40	170	164	150	110	188	179	168	183	175	-
45	191	184	169	124	211	201	189	206	196	-
50	213	204	188	138	235	224	210	229	218	-
55	227	218	200	147	250	238	224	244	233	-
60	247	238	218	161	273	260	244	267	254	-
65	268	257	237	174	296	282	264	289	275	-
70	289	277	255	187	318	304	285	311	296	-
75	309	297	273	201	341	325	305	333	317	-
80	327	314	289	212	361	344	323	353	336	-
85	348	334	307	226	384	366	343	375	357	-
90	368	354	325	239	406	387	363	397	378	-
95	389	373	343	252	429	409	384	419	399	-
100	409	393	361	266	452	430	404	441	420	-
105	431	414	381	280	476	454	426	465	442	-
110	452	434	399	293	499	475	446	487	464	-
115	472	454	417	307	521	497	466	509	485	-
120	493	474	435	320	544	519	487	531	506	-
125	513	493	453	333	567	540	507	553	527	-
130	534	513	472	347	589	562	527	576	548	-

* When the dose to be planted (Kg/Ha) is very small (position on the graduated scale ≤ 10), it is possible to obtain a more uniform planting by means of microdosing, even with a regular range of seeds (cereal and big seeds).

DOSAGE TABLES

WORKING WIDTH 5M REGULAR SIZE	Wheat	Rye	Barley	Oats	Beans	Peas	Lupin	Carob	Corn	Hierba
		Grass	0,68	0,5	0,85	0,81	0,76	0,83	0,79	0,36
Specific weight (Kg/l)	REGULAR SEED (Kg/Ha) – ADJUSTING POSITION NORMAL									
Position on the graduated scale	REGULAR SEED (Kg/Ha) – ADJUSTING POSITION NORMAL									
10	38,1	36,6	33,6	24,7	42,0	40,0	37,6	41,0	39,1	-
15	57,1	54,9	50,4	37,1	63,0	60,1	56,4	61,6	58,6	26,7
20	76,1	73,2	67,2	49,4	84,1	80,1	75,2	82,1	78,1	35,6
25	95,2	91,5	84,1	61,8	105	100	93,9	103	97,6	44,5
30	115	110	101	74,6	127	121	113	124	118	53,7
35	134	129	118	87,0	148	141	132	144	137	62,6
40	153	147	135	99,4	169	161	151	165	157	-
45	172	166	152	112	190	181	170	186	177	-
50	191	184	169	124	211	201	189	206	196	-
55	204	196	180	132	225	215	201	220	209	-
60	223	214	197	145	246	234	220	240	228	-
65	241	232	213	157	266	254	238	260	247	-
70	260	250	229	169	287	273	256	280	266	-
75	278	267	246	181	307	293	275	300	285	-
80	295	283	260	191	325	310	291	317	302	-
85	313	301	276	203	345	329	309	337	321	-
90	331	318	293	215	366	349	327	357	340	-
95	350	336	309	227	386	368	345	377	359	-
100	368	354	325	239	406	387	363	397	378	-
105	388	373	343	252	428	408	383	418	398	-
110	407	391	359	264	449	428	401	438	417	-
115	425	409	375	276	469	447	420	458	436	-
120	444	426	392	288	490	467	438	478	455	-
125	462	444	408	300	510	486	456	498	474	-
130	481	462	424	312	531	506	474	518	493	-

* When the dose to be planted (Kg/Ha) is very small (position on the graduated scale ≤ 10), it is possible to obtain a more uniform planting by means of microdosing, even with a regular range of seeds (cereal and big seeds).

WORKING WIDTH 6M REGULAR SIZE	Wheat	Rye	Barley	Oats	Beans	Peas	Lupin	Carob	Corn	Hierba
		Grass	0,68	0,5	0,85	0,81	0,76	0,83	0,79	0,36
Position on the graduated scale	REGULAR SEED (Kg/Ha) – ADJUSTING POSITION NORMAL									
10	31,7	30,5	28,0	20,6	35,0	33,4	31,3	34,2	32,5	-
15	47,6	45,7	42,0	30,9	52,5	50,1	47,0	51,3	48,8	22,2
20	63,5	61,0	56,0	41,2	70,0	66,7	62,6	68,4	65,1	29,7
25	79,3	76,2	70,0	51,5	87,6	83,4	78,3	85,5	81,4	37,1
30	95,7	92,0	84,5	62,2	106	101	94,5	103	98,2	44,7
35	112	107	98,6	72,5	123	117	110	120	115	52,2
40	128	123	113	82,9	141	134	126	138	131	-
45	144	138	127	93,2	158	151	142	155	147	-
50	160	153	141	104	176	168	157	172	164	-
55	170	163	150	110	188	179	168	183	174	-
60	185	178	164	120	205	195	183	200	190	-
65	201	193	177	130	222	211	198	217	206	-
70	216	208	191	141	239	228	214	233	222	-
75	232	223	205	151	256	244	229	250	238	-
80	245	236	217	159	271	258	242	265	252	-
85	261	251	230	169	288	274	257	281	268	-
90	276	265	244	179	305	290	273	298	283	-
95	291	280	257	189	322	307	288	314	299	-
100	307	295	271	199	339	323	303	331	315	-
105	323	311	286	210	357	340	319	349	332	-
110	339	326	299	220	374	356	334	365	348	-
115	354	340	313	230	391	373	350	382	363	-
120	370	355	326	240	408	389	365	398	379	-
125	385	370	340	250	425	405	380	415	395	-
130	400	385	354	260	442	421	395	432	411	-

* When the dose to be planted (Kg/Ha) is very small (position on the graduated scale ≤ 10), it is possible to obtain a more uniform planting by means of microdosing, even with a regular range of seeds (cereal and big seeds).

DOSAGE TABLES

WORKING WIDTH 8M REGULAR SIZE	Wheat	Rye	Barley	Oats	Beans	Peas	Lupin	Carob	Corn	Hierba
		Grass	0,68	0,5	0,85	0,81	0,76	0,83	0,79	0,36
Specific weight (Kg/l)	REGULAR SEED (Kg/Ha) – ADJUSTING POSITION NORMAL									
Position on the graduated scale	REGULAR SEED (Kg/Ha) – ADJUSTING POSITION NORMAL									
10	23,8	22,9	21,0	15,5	26,3	25,0	23,5	25,6	24,4	-
15	35,7	34,3	31,5	23,2	39,4	37,5	35,2	38,5	36,6	16,7
20	47,6	45,7	42,0	30,9	52,5	50,1	47,0	51,3	48,8	22,2
25	59,5	57,2	52,5	38,6	65,7	62,6	58,7	64,1	61,0	27,8
30	71,8	69,0	63,4	46,6	79,2	75,5	70,9	77,4	73,6	33,6
35	83,7	80,5	74,0	54,4	92,4	88,1	82,7	90,3	85,9	39,2
40	95,7	92,0	84,5	62,2	106	100,7	94,5	103	98,2	-
45	108	103	95,1	69,9	119	113	106	116	110	-
50	120	115	106	78	132	126	118	129	123	-
55	128	123	113	83	141	134	126	137	131	-
60	139	134	123	90	154	146	137	150	143	-
65	151	145	133	98	166	159	149	162	155	-
70	162	156	143	105	179	171	160	175	167	-
75	174	167	154	113	192	183	172	187	178	-
80	184	177	163	120	203	194	182	198	189	-
85	196	188	173	127	216	206	193	211	201	-
90	207	199	183	134	229	218	204	223	212	-
95	219	210	193	142	241	230	216	236	224	-
100	230	221	203	149	254	242	227	248	236	-
105	243	233	214	158	268	255	239	262	249	-
110	254	244	224	165	281	267	251	274	261	-
115	266	255	235	173	293	280	262	286	273	-
120	277	266	245	180	306	292	274	299	284	-
125	289	278	255	188	319	304	285	311	296	-
130	300	289	265	195	332	316	296	324	308	-

* When the dose to be planted (Kg/Ha) is very small (position on the graduated scale ≤ 10), it is possible to obtain a more uniform planting by means of microdosing, even with a regular range of seeds (cereal and big seeds).

11.3 FERTILISER DOSING IN MACHINES EQUIPPED WITH COULTERS

Fertiliser dosage tables are in Kg/Ha, which will be distributed by the machine depending on both the working width and the selected position on the dosing graduated scale.

WORKING WIDTH 3M REGULAR SIZE						
Specific weight (Kg/l)	0,8	0,9	1	1,1	1,2	1,3
Position on the graduated scale	REGULAR FERTILISER (Kg/Ha)					
10	65,9	74,2	82,4	90,6	98,9	107,1
15	98,9	111,2	123,6	136,0	148,3	161
20	132	148	165	181,3	198	214
25	165	185	206	227	247	268
30	199	224	249	273	298	323
35	232	261	290	319	348	377
40	265	298	331	365	398	431
45	298	336	373	410	447	485
50	331	373	414	456	497	539
55	353	397	442	486	530	574
60	385	434	482	530	578	626
65	418	470	522	574	626	678
70	450	506	562	618	674	731
75	482	542	602	662	723	783
80	510	574	637	701	765	829
85	542	610	677	745	813	881
90	574	645	717	789	861	932
95	606	681	757	833	908	984
100	637	717	797	877	956	1036
105	672	756	840	924	1008	1092
110	704	792	880	968	1056	1144
115	736	828	920	1012	1104	1196
120	768	864	960	1056	1152	1248
125	800	900	1000	1100	1200	1300
130	832	936	1040	1144	1248	1352

WORKING WIDTH 4M REGULAR SIZE						
Specific weight (Kg/l)	0,8	0,9	1	1,1	1,2	1,3
Position on the graduated scale	REGULAR FERTILISER (Kg/Ha)					
10	49,4	55,6	61,8	68,0	74,2	80,3
15	74,2	83,4	92,7	102,0	111,2	120,5
20	99	111	123,6	136,0	148	161
25	124	139	155	170,0	185	201
30	149	168	186	205	224	242
35	174	196	218	239	261	283
40	199	224	249	273	298	323
45	224	252	280	308	336	364
50	249	280	311	342	373	404
55	265	298	331	364	397	431
60	289	325	361	397	434	470
65	313	352	391	431	470	509
70	337	379	422	464	506	548
75	361	406	452	497	542	587
80	382	430	478	526	574	622
85	406	457	508	559	610	660
90	430	484	538	592	645	699
95	454	511	568	625	681	738
100	478	538	598	657	717	777
105	504	567	630	693	756	819
110	528	594	660	726	792	858
115	552	621	690	759	828	897
120	576	648	720	792	864	936
125	600	675	750	825	900	975
130	624	702	780	858	936	1014

WORKING WIDTH 5M REGULAR SIZE						
Specific weight (Kg/l)	0,8	0,9	1	1,1	1,2	1,3
Position on the graduated scale	REGULAR FERTILISER (Kg/Ha)					
10	39,6	44,5	49,4	54,4	59,3	64,3
15	59,3	66,7	74,2	81,6	89,0	96,4
20	79,1	89,0	98,9	108,8	118,7	129
25	99	111	124	136,0	148	161
30	119	134	149	164,1	179	194
35	139	157	174	191	209	226
40	159	179	199	219	239	259
45	179	201	224	246	268	291
50	199	224	249	273	298	323
55	212	238	265	291	318	344
60	231	260	289	318	347	376
65	251	282	313	344	376	407
70	270	304	337	371	405	438
75	289	325	361	397	434	470
80	306	344	382	421	459	497
85	325	366	406	447	488	528
90	344	387	430	473	516	559
95	363	409	454	500	545	590
100	382	430	478	526	574	622
105	403	454	504	555	605	655
110	422	475	528	581	634	687
115	442	497	552	607	663	718
120	461	519	576	634	691	749
125	480	540	600	660	720	780
130	499	562	624	687	749	811

WORKING WIDTH 6M REGULAR SIZE						
Specific weight (Kg/l)	0,8	0,9	1	1,1	1,2	1,3
Position on the graduated scale	REGULAR FERTILISER (Kg/Ha)					
10	33,0	37,1	41,2	45,3	49,4	53,6
15	49,4	55,6	61,8	68,0	74,2	80,3
20	65,9	74,2	82,4	90,6	98,9	107,1
25	82	93	103,0	113,3	124	134
30	99	112	124	136,7	149	162
35	116	131	145	159,5	174	189
40	133	149	166	182	199	215
45	149	168	186	205	224	242
50	166	186	207	228	249	269
55	177	199	221	243	265	287
60	193	217	241	265	289	313
65	209	235	261	287	313	339
70	225	253	281	309	337	365
75	241	271	301	331	361	391
80	255	287	319	351	382	414
85	271	305	339	373	406	440
90	287	323	359	394	430	466
95	303	341	379	416	454	492
100	319	359	398	438	478	518
105	336	378	420	462	504	546
110	352	396	440	484	528	572
115	368	414	460	506	552	598
120	384	432	480	528	576	624
125	400	450	500	550	600	650
130	416	468	520	572	624	676

11.4 FERTILISER DOSING IN PLANTERS

Fertiliser dosage tables are in Kg/Ha, which depends on both the row number and the row spacing. Depending on the kilograms per hectare to be fertilised and the previous factors, the dosing graduated scale will be set to the position shown in the table or to the adjusted position as calculated in section 7.4.3 FERTILISER DOSING ADJUSTMENTS. This is an example showing how to use a fertiliser dose of 268 Kg/Ha:

ROW NUMBER	9						
	ROW SPACING (cm)						
Position on the graduated scale	45	50	55	60	70	75	80
5							
10							
15							
20							
25							
30							
35			176				
40							
45							
50							
55							
60							
65							
70							
75							
80							
85							
90							
95							
100							
105							
110							
115							
120							
125							
130							

Kg./ha

Kg./ha

DOSAGE TABLES

ROW NUMBER	6						
	ROW SPACING (cm)						
	45	50	55	60	70	75	80
5	45,8	41,2	37,5	34,3	29,4	27,5	25,8
10	91,6	82,4	74,9	68,7	58,9	54,9	51,5
15	137	124	112	103	88,3	82,4	77,3
20	183	165	150	137	118	110	103
25	229	206	187	172	147	137	129
30	276	249	226	207	178	166	155
35	322	290	264	242	207	193	181
40	368	331	301	276	237	221	207
45	414	373	339	311	266	249	233
50	460	414	377	345	296	276	259
55	491	442	401	368	315	294	276
60	535	482	438	401	344	321	301
65	580	522	474	435	373	348	326
70	625	562	511	468	401	375	351
75	669	602	547	502	430	401	376
80	708	637	580	531	455	425	398
85	753	677	616	564	484	452	423
90	797	717	652	598	512	478	448
95	841	757	688	631	541	505	473
100	885	797	724	664	569	531	498
105	934	840	764	700	600	560	525
110	978	880	800	733	629	587	550
115	1022	920	837	767	657	613	575
120	1067	960	873	800	686	640	600
125	1111	1000	909	834	714	667	625
130	1156	1040	946	867	743	693	650
Kg./ha							

ROW NUMBER	7						
	ROW SPACING (cm)						
	45	50	55	60	70	75	80
5	39,2	35,3	32,1	29,4	25,2	23,5	22,1
10	78,5	70,6	64,2	58,9	50,5	47,1	44,1
15	118	106	96,3	88,3	75,7	70,6	66,2
20	157	141	128	118	101	94,2	88,3
25	196	177	161	147	126	118	110
30	237	213	194	178	152	142	133
35	276	249	226	207	178	166	155
40	316	284	258	237	203	189	178
45	355	320	291	266	228	213	200
50	395	355	323	296	254	237	222
55	421	379	344	315	270	252	237
60	459	413	375	344	295	275	258
65	497	447	407	373	320	298	280
70	535	482	438	401	344	321	301
75	574	516	469	430	369	344	323
80	607	546	497	455	390	364	342
85	645	581	528	484	415	387	363
90	683	615	559	512	439	410	384
95	721	649	590	541	463	433	406
100	759	683	621	569	488	455	427
105	800	720	655	600	514	480	450
110	838	754	686	629	539	503	472
115	876	789	717	657	563	526	493
120	914	823	748	686	588	549	514
125	953	857	779	714	612	572	536
130	991	892	811	743	637	594	557
Kg./ha							

ROW NUMBER	9						Kg./ha
	ROW SPACING (cm)						
	45	50	55	60	70	75	
Position on the graduated scale							
5	30,5	27,5	25,0	22,9	19,6	18,3	17,2
10	61,0	54,9	49,9	45,8	39,2	36,6	34,3
15	91,6	82,4	74,9	68,7	58,9	54,9	51,5
20	122	110	99,9	91,6	78,5	73,2	68,7
25	153	137	125	114	98,1	91,6	85,8
30	184	166	151	138	118	110	104
35	215	193	176	161	138	129	121
40	246	221	201	184	158	147	138
45	276	249	226	207	178	166	155
50	307	276	251	230	197	184	173
55	327	294	268	245	210	196	184
60	357	321	292	268	229	214	201
65	387	348	316	290	249	232	217
70	416	375	341	312	268	250	234
75	446	401	365	335	287	268	251
80	472	425	386	354	304	283	266
85	502	452	411	376	323	301	282
90	531	478	435	398	342	319	299
95	561	505	459	421	360	336	315
100	590	531	483	443	379	354	332
105	622	560	509	467	400	373	350
110	652	587	533	489	419	391	367
115	682	613	558	511	438	409	383
120	711	640	582	533	457	427	400
125	741	667	606	556	476	445	417
130	771	693	630	578	495	462	433

ROW NUMBER	8						Kg./ha
	ROW SPACING (cm)						
	45	50	55	60	70	75	
Position on the graduated scale							
5	34,3	30,9	28,1	25,8	22,1	20,6	19,3
10	68,7	61,8	56,2	51,5	44,1	41,2	38,6
15	103	92,7	84,3	77,3	66,2	61,8	57,9
20	137	124	112	103	88,3	82,4	77,3
25	172	155	140	129	110	103	96,6
30	207	186	170	155	133	124	117
35	242	218	198	181	155	145	136
40	276	249	226	207	178	166	155
45	311	280	254	233	200	186	175
50	345	311	283	259	222	207	194
55	368	331	301	276	237	221	207
60	401	361	328	301	258	241	226
65	435	391	356	326	280	261	245
70	468	422	383	351	301	281	263
75	502	452	411	376	323	301	282
80	531	478	435	398	342	319	299
85	564	508	462	423	363	339	317
90	598	538	489	448	384	359	336
95	631	568	516	473	406	379	355
100	664	598	543	498	427	398	374
105	700	630	573	525	450	420	394
110	733	660	600	550	472	440	413
115	767	690	627	575	493	460	431
120	800	720	655	600	514	480	450
125	834	750	682	625	536	500	469
130	867	780	709	650	557	520	488

DOSAGE TABLES

ROW NUMBER	10						
	ROW SPACING (cm)						
	45	50	55	60	70	75	80
5	27,5	24,7	22,5	20,6	17,7	16,5	15,5
10	54,9	49,4	44,9	41,2	35,3	33,0	30,9
15	82,4	74,2	67,4	61,8	53,0	49,4	46,4
20	110	98,9	89,9	82,4	70,6	65,9	61,8
25	137	124	112	103	88,3	82,4	77,3
30	166	149	136	124	107	99,4	93,2
35	193	174	158	145	124	116	109
40	221	199	181	166	142	133	124
45	249	224	203	186	160	149	140
50	276	249	226	207	178	166	155
55	294	265	241	221	189	177	166
60	321	289	263	241	206	193	181
65	348	313	285	261	224	209	196
70	375	337	307	281	241	225	211
75	401	361	328	301	258	241	226
80	425	382	348	319	273	255	239
85	452	406	369	339	290	271	254
90	478	430	391	359	307	287	269
95	505	454	413	379	324	303	284
100	531	478	435	398	342	319	299
105	560	504	458	420	360	336	315
110	587	528	480	440	377	352	330
115	613	552	502	460	394	368	345
120	640	576	524	480	412	384	360
125	667	600	546	500	429	400	375
130	693	624	567	520	446	416	390
Kg./ha							

ROW NUMBER	11						
	ROW SPACING (cm)						
	45	50	55	60	70	75	80
5	25,0	22,5	20,4	18,7	16,1	15,0	14,0
10	49,9	44,9	40,9	37,5	32,1	30,0	28,1
15	74,9	67,4	61,3	56,2	48,2	44,9	42,1
20	99,9	89,9	81,7	74,9	64,2	59,9	56,2
25	125	112	102	93,6	80,3	74,9	70,2
30	151	136	123	113	96,9	90,4	84,8
35	176	158	144	132	113	105	98,9
40	201	181	164	151	129	121	113
45	226	203	185	170	145	136	127
50	251	226	205	188	161	151	141
55	268	241	219	201	172	161	151
60	292	263	239	219	188	175	164
65	316	285	259	237	203	190	178
70	341	307	279	255	219	204	192
75	365	328	299	274	235	219	205
80	386	348	316	290	248	232	217
85	411	369	336	308	264	246	231
90	435	391	356	326	279	261	244
95	459	413	375	344	295	275	258
100	483	435	395	362	310	290	272
105	509	458	417	382	327	306	286
110	533	480	436	400	343	320	300
115	558	502	456	418	359	335	314
120	582	524	476	436	374	349	327
125	606	546	496	455	390	364	341
130	630	567	516	473	405	378	355
Kg./ha							

ROW NUMBER	13						Kg./ha
	ROW SPACING (cm)						
	45	50	55	60	70	75	
5	21,1	19,0	17,3	15,8	13,6	12,7	11,9
10	42,3	38,0	34,6	31,7	27,2	25,4	23,8
15	63,4	57,0	51,9	47,5	40,7	38,0	35,7
20	84,5	76,1	69,1	63,4	54,3	50,7	47,5
25	106	95,1	86,4	79,2	67,9	63,4	59,4
30	127	115	104	95,6	82,0	76,5	71,7
35	149	134	122	112	95,6	89,2	83,7
40	170	153	139	127	109	102	95,6
45	191	172	156	143	123	115	108
50	212	191	174	159	137	127	120
55	226	204	185	170	146	136	127
60	247	222	202	185	159	148	139
65	268	241	219	201	172	161	151
70	288	259	236	216	185	173	162
75	309	278	253	232	199	185	174
80	327	294	267	245	210	196	184
85	347	313	284	261	223	208	195
90	368	331	301	276	236	221	207
95	388	349	318	291	250	233	218
100	409	368	334	306	263	245	230
105	431	388	353	323	277	259	242
110	451	406	369	339	290	271	254
115	472	425	386	354	303	283	265
120	492	443	403	369	317	295	277
125	513	462	420	385	330	308	289
130	533	480	436	400	343	320	300

ROW NUMBER	12						Kg./ha
	ROW SPACING (cm)						
	45	50	55	60	70	75	
5	21,1	19,0	17,3	15,8	13,6	12,7	11,9
10	42,3	38,0	34,6	31,7	27,2	25,4	23,8
15	63,4	57,0	51,9	47,5	40,7	38,0	35,7
20	84,5	76,1	69,1	63,4	54,3	50,7	47,5
25	106	95,1	86,4	79,2	67,9	63,4	59,4
30	127	115	104	95,6	82,0	76,5	71,7
35	149	134	122	112	95,6	89,2	83,7
40	170	153	139	127	109	102	95,6
45	191	172	156	143	123	115	108
50	212	191	174	159	137	127	120
55	226	204	185	170	146	136	127
60	247	222	202	185	159	148	139
65	268	241	219	201	172	161	151
70	288	259	236	216	185	173	162
75	309	278	253	232	199	185	174
80	327	294	267	245	210	196	184
85	347	313	284	261	223	208	195
90	368	331	301	276	236	221	207
95	388	349	318	291	250	233	218
100	409	368	334	306	263	245	230
105	431	388	353	323	277	259	242
110	451	406	369	339	290	271	254
115	472	425	386	354	303	283	265
120	492	443	403	369	317	295	277
125	513	462	420	385	330	308	289
130	533	480	436	400	343	320	300

12. WARRANTY

MAQUINARIA AGRÍCOLA SOLÀ, S.L. ensures the smooth functioning of any product according to the technical specifications of the WARRANTY CERTIFICATE provided with each machine. Any delivery note accompanying the goods will eventually result in a VAT invoice. If the BUYER considers the goods to be in warranty and they should not be invoiced, the problem will be analyzed and, if appropriate, your account will be credited. In order for the warranty to be valid, the WARRANTY CERTIFICATE must be returned once it has been properly filled in by the DEALERSHIP and the BUYER.

MAQUINARIA AGRÍCOLA SOLÀ, S.L. will not be held responsible for any damage caused by misuse, or by not checking the smooth functioning of the goods when either starting the machine or during the sowing season (see section 3.2).

Neither the DEALERSHIP or the BUYER or the USER will be able to claim compensation to MAQUINARIA AGRÍCOLA SOLÀ, S.L. for incidental damages such as labour costs, transport, faulty work, damages to persons or goods, harvest loss or reduced harvest, etc.

Material exchanges or returns will be paid by the buyer with the previous consent of MAQUINARIA AGRÍCOLA SOLÀ, S.L. OPTIONAL EQUIPMENT and SPARE PARTS which have surpassed three months since delivery or have been manufactured ex professo, will only be accepted as an exception. Parts eligible for warranty coverage need to be returned to the factory to be checked and eventually exchanged, They need to be returned accompanied with a note explaining the problem and containing the machine model and serial number. Warranty coverage remains subject to the decision of MAQUINARIA AGRÍCOLA SOLÀ, S.L. Any repair which has not been approved by MAQUINARIA AGRÍCOLA SOLÀ, S.L. will not be covered under WARRANTY.

13. SPARE PARTS

The terms **RIGHT, LEFT, FRONT and REAR** refer to the machine in its starting direction.

When guidance describes parts that have a matching pair (symmetrical handles, wheels etc) only one will be demonstrated in the drawings shown. Please search for the distinguishing reference in the spare parts list.

The number and type of the machine can be found on the machine's **IDENTIFICATION PLATE**, on the front part of the frame.



BE CAREFUL WHEN MAINTAINING THE MACHINE, SHARP EDGES CAN CAUSE INJURY.



DO NOT WORK UNDER THE MACHINE WHEN IT IS RAISED. ALWAYS SECURE THE MACHINE PROPERLY TO PREVENT IT FROM COLLAPSING AS A PRESSURE LOSS IN THE TRACTOR CAN OCCUR.



13.1 DISTRIBUTOR

N.	REF.	DESCRIPTION
1	CO-044208	DOSIFICADOR DOSAL N130/F30
2	985 6 I	TUERCA DIN 985 M6 INOX
3	125 6 I	ARANDELA PLANA DIN 125 M6 INOXIDABLE
4	933 6X20 I	TORNILLO DIN 933 M6X20 INOX
5	AL-D11666X	CASQUILLO PLANO DISTRIBUIDOR
6	471 22 I	ANILLO SAEGER DIN 471 22 INOX.
7	AL-D11629	TUERCA ARRASTRE M14 LATON
8	AL-E12835	TAPA DOSIFICADOR DE ACERO INOXIDABLE CON FUELLE
9	AL-D12439	TAPAJUNTAS DOSIFICADOR
10	AL-D12859X	REFUERZO TAPAJUNTAS DOSIFICADOR
11	AL-E15603	PUERTA INFERIOR DOSIFICADOR INOX.
12	AL-D12199	PALETA INFERIOR DOSIFICADOR
13	AL-C50102	VOLANTE DE 6 LÓBULOS M6
14	AL-D15542	PLETINA DE VACIADO DOSIFICADOR
15	AL-D11660	COMPUERTA DE VACIADO INOX.
16	985 8 I	TUERCA DIN 985 M8 INOX
17	125 8 I	ARANDELA DIN 125 M8 INOX
18	AL-C50114X	RESORTE PISTON INOX
19	AL-D11661X	PALANCA DEL REGULADOR
20	934 8 I	TUERCA DIN 934 M8 INOX
21	9021 8 I	ARANDELA PLANA DIN 9021 M-8 INOXIDABLE
22	7380 8X25 I	TORNILLO DIN 7380 M8X25 INOX
23	AL-D15557	CASQUILLO DE AJUSTE EXTERNO
24	AL-D12428X	PLACA DE AJUSTE DOSIFICADOR
25	AL-E12434X	MANIVELA DOSIFICADOR
26	933 6X25 I	TORNILLO DIN 933 M6X25 INOX
27	471 15 I	ANILLO SAEGER DIN 471 15 INOX.
28	FE-600628	RODAMIENTO 6002 2RS 15X32X9 INOX.
29	AL-D11623X	ALOJAMIENTO COJINETE 6002 DOSIFICADOR
30	AL-D11652X	CUBIERTA PARA COJINETE 6002
31	933 8X20 I	TORNILLO DIN 933 M8X20 INOX
32	AL-D12452	ADHESICO 0-130 DOSIFICADOR INOX.
33	AL-E15550	CARCASA DOSIFICADOR N130/F30
34	AL-D12330	CEPILLO D=12X62 L=14
35	AL-D11630X	TORNILLO PARA CEPILLO INOX.
36	7981C 4,2X19 I	TORNILLO DIN 7981C 4,2X19 INOX
37	AL-D11671	CEPILLO DE LIMPIEZA 135X35X10
38	AL-C05078	PASADOR SEGURIDADA 8X60 INOX
39	AL-D12512X	DISTANCIADOR D=21,3X15,5 L=24,5
40	125 15 I	ARANDELA PLANA DIN 125 15 INOX.
41	AL-E12489	TAPA MOTRIZ DOSIFICADOR INOX.
42	931 6X70 I	TORNILLO DIN 931 M6X70 INOX.

N.	REF.	DESCRIPTION
43	913 6X12 I	TORNILLO DIN 913 M6X12 INOX
44	7 5X28 I	PASADOR DIN 7 Ø5X28 INOX
45	AL-D12438	PIÑON Z28 DOSIF. INOX.
46	AL-D16320	DISTANCIADOR EJE SEMILLA
47	551 10X19 I	TORNILLO DIN 551 M10X19 INOX
48	AL-D12437	PIÑON Z19 DOSIF. INOX.
49	AL-D12447	ANILLO DENTADO PARA LA DOSIFICACION DE SEMILLA
50	471 50 I	ANILLO SAEGER DIN 471 50 INOX
51	FE-600629	RODAMIENTO 6010 2RS 50X80X16 INOX
52	AL-D11624X	ALOJAMIENTO COJINETE 6010
53	AL-E16510	SOPORTE SEMILLAS GRANDES DOSIFICADOR
54	AL-D15556	EXTENSION D=32X23,8X20 L=27
55	AL-D12445	PERNO EMPUJADOR PARA SEMILLAS GRANDES
56	AL-D12448	EJE HEXAGONO 17/30 DISTRIBUIDOR
57	AL-D12444	ROTOR PRINCIPAL DOSIFICADOR
58	AL-D16322	EJE HEXAGONAL INOX.
59	AL-D12436	PIÑON Z14 DOSIF. INOX.
60	AL-C50560	IMAN D20X10
61	7991 4X18 I	TORNILLO DIN 7991 4X18 INOX
62	1481 5X35 I	PASADOR ELÁSTICO DIN 1481 Ø5X35 INOX
63	AL-D16321	EJE AGITADOR INOXIDABLE PARA ALIMENTADOR
64	AL-C20A03203	ENCAJE DOSIFICADOR PARA CAJA COLECTORA

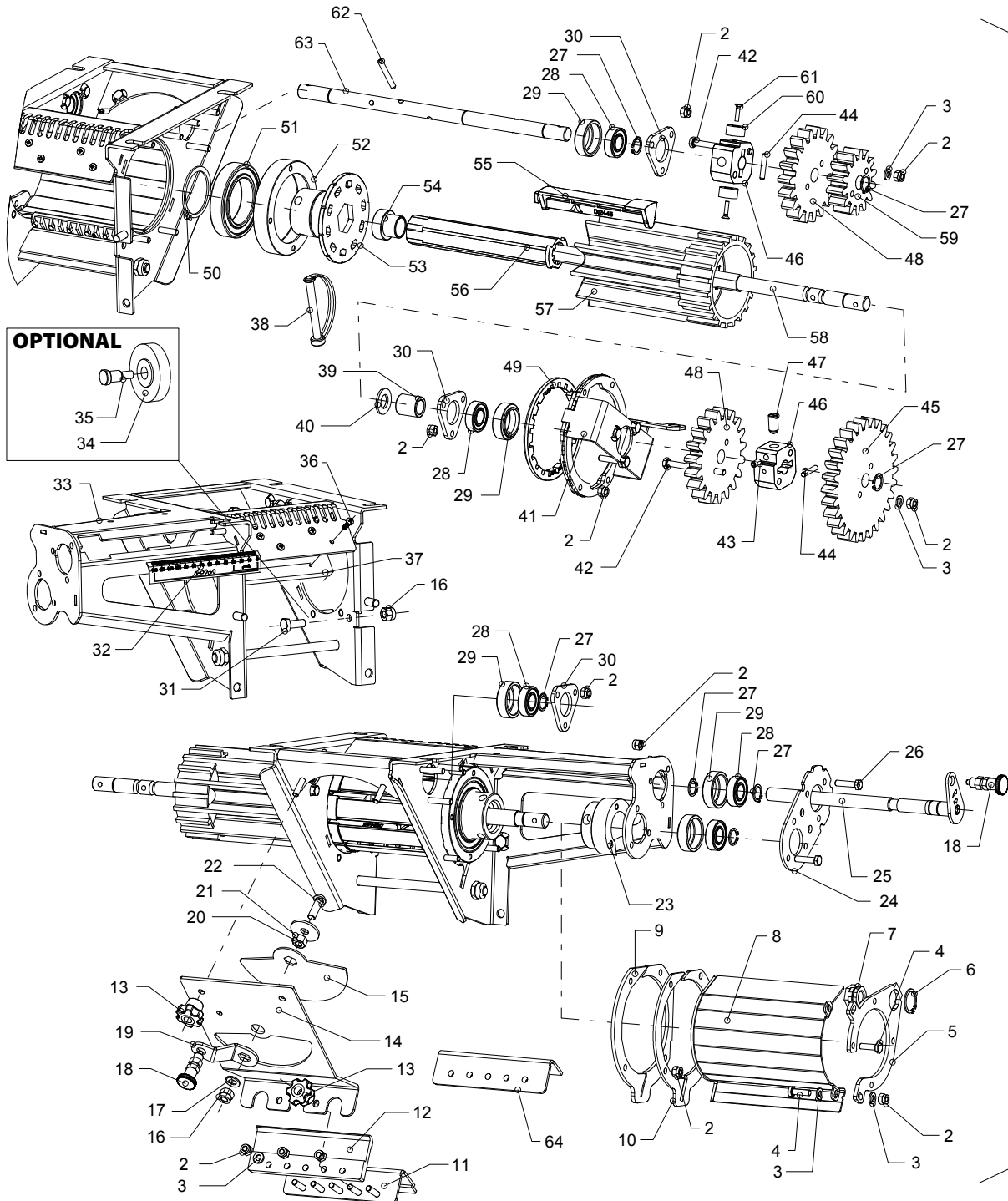

WARRANTY

13.2 MECHANICAL TRANSMISSION

N.	REF.	DESCRIPTION
1	ME-044210	CASQUILLO SEPARADOR TRANSMISION RUEDA
2	472 47	ANILLO SAEGER DIN 472 47
3	FE-600047	RODAMIENTO 6005 2RS CLASE C CNR
4	PS-044200	BRAZO TRANSMISION RUEDA
5	PS-044201	RUEDA TRANSMISION
6	CT-044205	EJE HEXAGONAL L=250 mm
7	CO-141736	TRANSMISION 90° HEX. 19 1:1 (S.W. 2023)
8	CT-044206	EJE HEXAGONAL L=900 mm
9	PX-014228	SOPORTE GUIA TRANSMISION DER.
10	985 12	TUERCA DIN 985 M12
11	125 12 BI	ARANDELA PLANA DIN 125 12 BI
12	985 8	TUERCA DIN 985 M8
13	933 8X20 8.8 B	TORNILLO DIN 933 M8X20 8.8 BI
14	EE-041701	SOPORTE RODAMIENTO 6005 PROSEM
15	933 12X30 8.8 B	TORNILLO DIN 933 M12X30 8.8 BI
16	PX-044241	CHAPA SUJECION MUELLE
17	933 10X25 8.8 B	TORNILLO DIN 933 M10X25 8.8 BI
18	985 10	TUERCA DIN 985 M10
19	ME-044207	EJE SUPERIOR TRANSMISION
20	PL-041714	FUELLE JUNTA UNIVERSAL 104G
21	FE-606013	BRIDA NYLON 4,8X200
22	FE-610004	PASADOR "R" DE 5 MM
23	AD-071710	ADHESIVO ENGRASE
24	PS-044209	TUBO HEMBRA TRANSM.TELESOPICA KIBLI
25	PS-044208	PASAMANO MACHO TRANSM. TELESCOPICA KIBLI
26	PS-014203	OREJA SOPORTE PISTON
27	933 8X25 8.8 B	TORNILLO DIN 933 8X25 8.8 BI
28	PS-014204	BULON SOPORTE PISTON
29	94 8X45 BI	PASADOR DE ALETAS DIN 94 M 8X45 BI
30	125 20 BI	ARANDELA DIN 125 M20 BI
31	ME-044203	BULON SUJECION PISTON BRAZO TRANSMISION
32	94 4X50 BI	PASADOR DE ALETAS DIN 94 M 4X50 BI
33	935 20 BI	TUERCA DIN 935 M20 BI
34	FE-600018	COJINETE 25/28/16,5
35	125 14 BI	ARANDELA DIN-125 M14 BI
36	985 14	TUERCA DIN 985 M14
37	ML-050201	MUELLE BRAZO CORTO EURO
38	931 14X70 8.8 B	TORNILLO DIN 931 M14X70 8.8 BI
39	FE-660010	TOPE GOMA Ø30x20 M8x23
40	125 8	ARANDELA PLANA DIN 125 M8
41	931 6X35 8.8 B	TORNILLO DIN 931 6X35 8.8 BICROMATADO
42	125 6 BI	ARANDELA PLANA DIN 125 M6 BICROMATADA

N.	REF.	DESCRIPTION
43	PX-141726	BLOQUEADOR HEX. 19
44	985 6	TUERCA DIN 985 M6
45	PX-042820	DISTANCIADOR HEX. 19 E=5
46	471 25	ANILLO SAEGER DIN 471 25
47	ME-041711	EJE TUBO HEX. PARA 6005 P.V. PROSEM
48	MO-041701	EJE RUEDA 8,5" CON PERNOS PROSEM

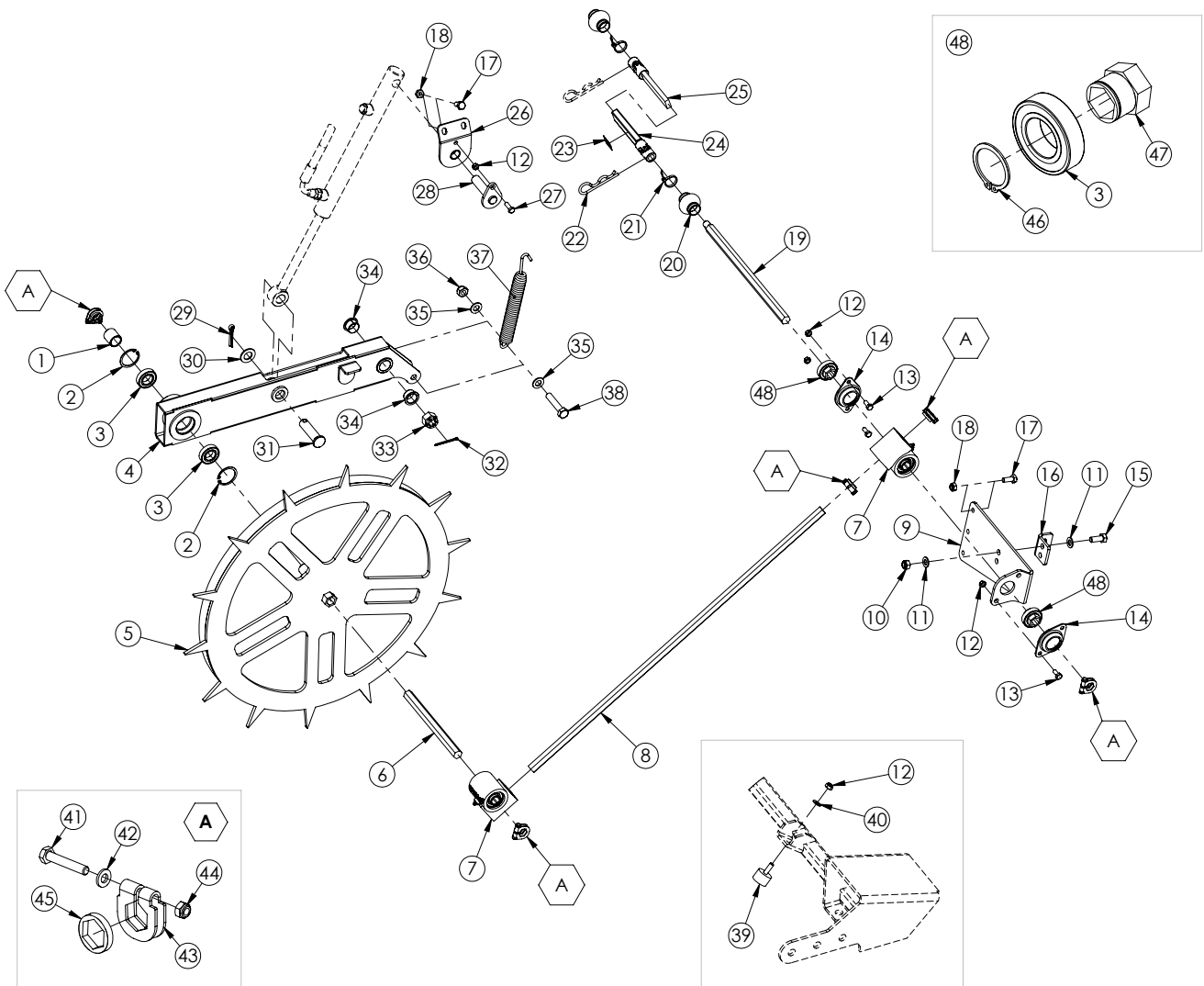

13.3 HYDRAULIC FAN

N.	REF.	DESCRIPTION
1	HI-701015	ENCHUFE RAPIDO DE PUNZON HEMBRA 3/4"
2	HI-707010	TAPON M PARA HEMBRA ENCHUFE RAPIDO 3/4"
3	HI-707011	TAPON H PARA MACHO ENCHUFE RAPIDO 3/4"
4	HI-705004	ARANDELA METALBUNA 3/4"
5	HI-701014	ENCHUFE RAPIDO DE PUNZON MACHO 3/4"
6	HI-700271	TUBO R2AT 5/8" L=1,2 m TL3/4"-MF3/4"
7	HI-704071	RACOR PASATABIQUES 3/4" CON TUERCA
8	933 8X20 8.8 B	TORNILLO DIN 933 M8X20 8.8 BI
9	PX-014230	SOPORTE RACOR HIDRAULICOS
10	125 26	ARANDELA PLANA DIN 125 M6
11	985 8	TUERCA DIN 985 M8
12	HI-704066	RACOR UNION MF3/4"-HG3/4"
13	HI-703011	RACOR T MF3/4"-MF3/4"-HG3/4 LATERAL
14	HI-700272	TUBO R2AT 5/8" L=0,7 m H90°G 3/4" -H90°G3/4" A 90°
15	HI-704012	RACOR UNION MF3/4"-MF3/4"
16	HI-708048	RADIADOR ACEITE RAL2
17	FE-650020	CLAVIJA 3 POLOS MACHO NEUMASEM
18	HI-705005	ARANDELA METALBUNA 1"
19	HI-704034	RACOR UNION MF 3/4";MF 1"
20	HI-700274	TUBO R2AT 5/8" L=0,85m H90°G 3/4" -H90°G3/4" A 180°
21	HI-708057	BRIDA ACODADA 3/4" SALIDA MOTOR CON ANTIRRETORNO
22	HI-708055	MOTOR HIDRAULICO 8,3CM ANTIRETORNO INCORPORADO
23	HI-708056	BRIDA ACODADA 1/2" ENTRADA MOTOR CON ANTIRETORNO
24	HI-705002	ARANDELA METALBUNA 1/2"
25	HI-704004	RACOR UNION MF1/2"-MF1/2"
26	HI-700273	TUBO R2AT 5/8" L=0,7 m TL1/2" - H90°G1/2"
27	HI-704075	RACOR UNION MF1/2"-HG3/4"
28	HI-706014	VALVULA RF-A-12 REGULADORA CAUDAL 1/2"
29	HI-704065	RACOR UNION MF1/2"-HG1/2"
30	125 22 BI	ARANDELA DIN 125 M22 BI
31	HI-704018	RACOR PASATABIQUES 1/2" CON TUERCA
32	HI-700270	TUBO R2AT 5/8" L=1,2 m TL1/2"-MF1/2"
33	HI-701000	ENCHUFE RÁPIDO MACHO 1/2" CETOP ISO A - TIPO FASTE
34	HI-707001	PROTECTOR P/ACOPAMIENTO HIDR. RAPIDO HEMBRA 1/2
35	912 6X35 8.8 BI	TORNILLO ALLEN DIN 912 M6X35 8.8 BICROMATADO
36	912 6X55 8.8 BI	TORNILLO ALLEN DIN 912 M6X55 8.8 BICROMATADO
37	127 6 BI	ARANDELA DIN 127 M6 BI
38	HI-708057/00	BRIDA ACODADA 3/4" SIN JUNTA SIN TORNILLERIA
39	FE-601092	JUNTA TORICA Ø 24X2
40	FE-601091	JUNTA TORICA Ø 16X2
41	HI-708056/00	BRIDA ACODADA 1/2" SIN JUNTA SIN TORNILLERIA

N.	REF.	DESCRIPTION
42	127 6 BI	ARANDELA DIN 127 M6 BI
43	912 6X45 8.8 BI	TORNILLO ALLEN DIN 912 M6X45 8.8 BICROMATADO
44	912 6X30 BI	TORNILLO ALLEN DIN 912 M-6X30
45	7343 8X32	PASADOR ELASTICO ESPIRAL DIN 7343 8X32
46	ME-041347	ADAPTADOR EJE MOTOR-TURBINA NEUMASEM
47	ME-241764	EJE TURBINA HIDRAULICA PROSEM
48	472 72	ANILLO SAEGER DIN 472 72
49	PX-141785	ARANDELA Ø32XØ38X2
50	FE-600051	RODAMIENTO 6306 2RS CLASE A
51	ME-044209	SOPORTE MOTOR HIDRAULICO
52	ME-041736	SEPARADOR RODAMIENTOS EJE TURBINA PROSEM
53	FE-606033	BRIDA SINFIN 160-180/9
54	VA-044201	TUBO FLEXIBLE AIRE TURBINA TURB.HIDRAULICA
55	981 25/150	VIROLA SEGURIDAD DIN 981 M25X1.5 KM5
56	6921 6X10 8.8 B	TORNILLO DIN 6921 M6X10 8.8 BICROMATADO
57	CO-141729	TAPA TURBINA GT-SOF
58	CO-141730	GIRANTE TURBINA GT-SOF
59	CO-141728	CAJA TURBINA GT-SOF
60	FE-606019	BRIDA SINFIN 130/150-9
61	VA-044204	TUBO FLEXIBLE ENTRADA DISTRIBUIDOR TURB.HIDRAULICA
62	MO-044202	BUJE CON EJE TURBINA HIDRAULICA KIBLI
63	985 12	TUERCA DIN 985 M12
64	6885-A 8X7X25	CHAVETA DIN 6885 FORMA A DE 8X7X25
65	127 8 BI	ARANDELA DIN 127 M8 BI
66	912 8X30 8.8 BI	TORNILLO DIN 912 M8X30 8.8 BI
67	985 6	TUERCA DIN 985 M6
68	9021 6 BI	ARANDELA PLANA DIN 9021 M6 BI
69	FE-660041	SILENTBLOCK SERIE T M6X18 Ø:20 H:20

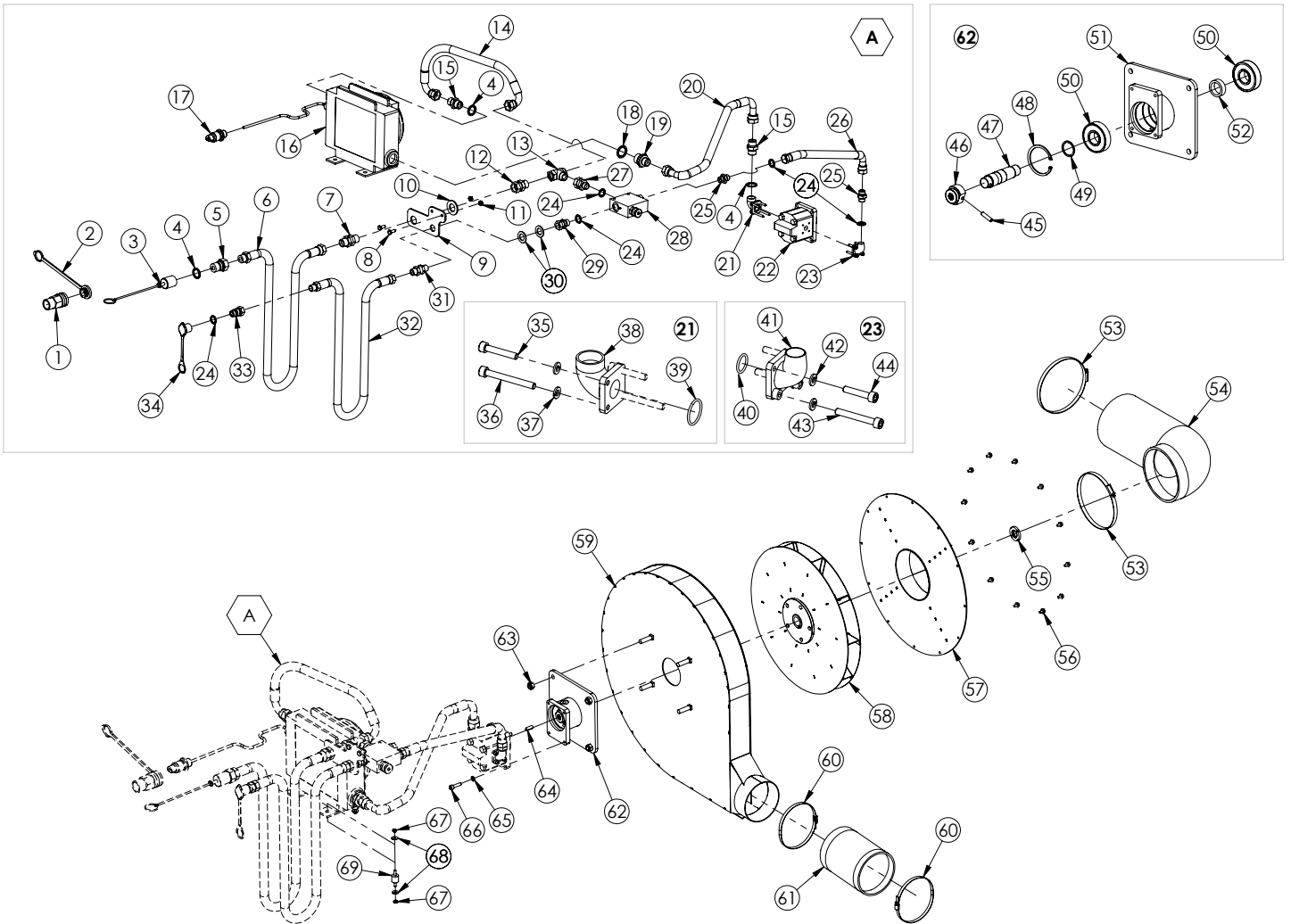

WARRANTY

MAQUINARIA AGRÍCOLA SOLÀ, S.L.

Ctra. de Igualada, s/n. Apdo. Correos, 11
08280 **CALAF** (Barcelona) **SPAIN**

Tel. 34 93 868 00 60*

Fax. 34 93 868 00 55

www.solagrupo.com

e-mail: sola@solagrupo.com



MAQUINARIA AGRÍCOLA