

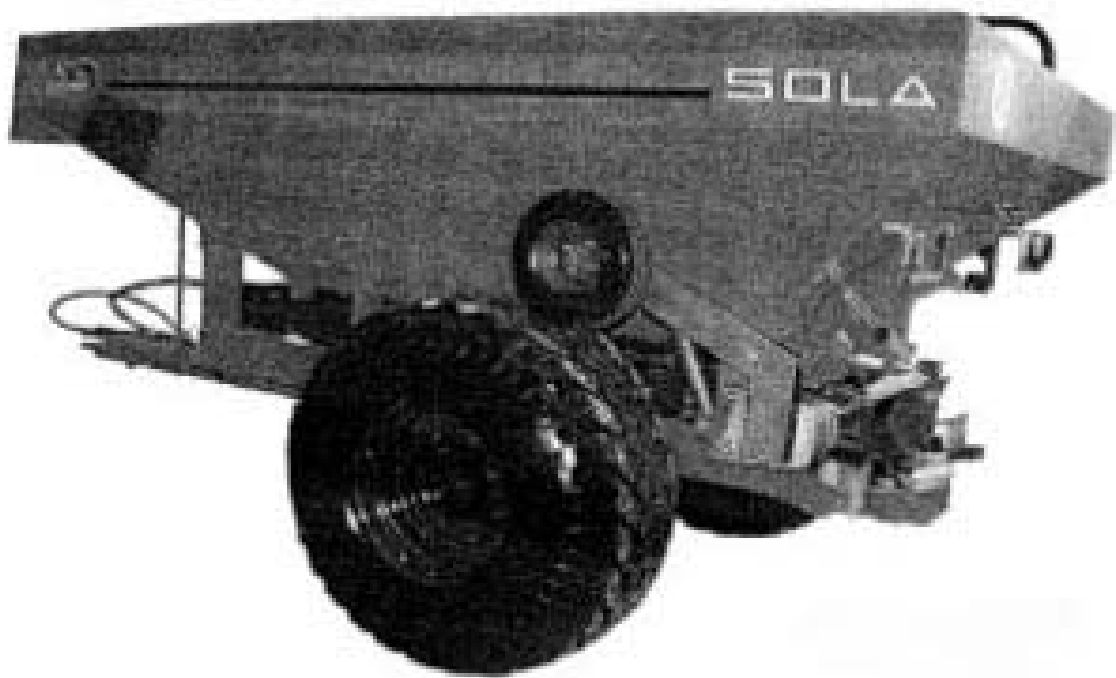

SOLA

CONVEYOR BAND FERTILIZER SPREADERS

SV-6/SV-7



**STARTING
MAINTENANCE
DOSAGE
SPARE PARTS**

read arefully this booklet before operating the machine

Ref.: CN-811015
4. st edition - 2010
Total or partial reproduction prohibited

Specifications subject to modifications without prior notice

SOLÀ seed drills and fertilizer spreaders are manufactured in a factory specialized in this area. They are guaranteed by thousands of users experience.

They are high technology machines, planned for a long service, without breakdowns, in very different conditions and with a simple and efficient mechanism designed to do an excellent work with minimum maintenance.

With this information about characteristics, possibilities and adjustments, we wish to help you to obtain all that you expect from our machine.



Certified Quality System

TABLE OF CONTENTS

1	INTRODUCTION.....	5
2	TECHNICAL SPECIFICATIONS.....	6
3	SAFETY INTRUCTIONS.....	7
4	ESSENCIAL CONCEPTS FOR FERTILIZING.....	11
5	SETTING OF THE FERTILIZER SPREADER.....	12
6	FLOW TEST.....	14
7	MAINTENANCE.....	15
8.	DOSAGE TABLES.....	17
9.	SPARE PARTS.....	21

1. INTRODUCTION

Before you proceed to operate the fertilizer spreader, please read and observe these instructions. In this way, you will avoid accidents, reduce repair costs and downtimes and increase the reliability and service life of your fertilizer spreader.

This operating manual must be read and used by all persons who are required to work with the fertilizer spreader (including preparatory works, troubleshooting during operation, care), maintenance (inspection and technical servicing) and transporting.

Pay particular attention to the safety and technical instructions. SOLÀ cannot assume any liability for damage or malfunctions caused by a failure to observe the instructions contained in this operating manual.

First of all, the manual will explain the Technical Specifications, the Safety instructions, and some Essential Concepts for fertilizing. In the chapters STARTING, OPTIONAL EQUIPMENTS and MAINTENANCE, the manual will explain the basic instructions for working with the machine.

This manual is finished with a Dosage Tables with different types of fertilizer and a Spare Parts List.



SOLÀ reserves the right to make changes to the illustrations, technical specifications and weights contained in this operating manual if SOLÀ makes any improvements to the fertilizer spreaders.

TECHNICAL SPECIFICATIONS

2. TECHNICAL SPECIFICATIONS

Type	SV-6	SV-6 with sight	SV-7	SV-7 with sight
Capacity (litres)	5550	6800	6400	8300
Total height (m)	2,03	2,18	2,03	2,23
Hopper width (m)	2,45	2,45	2,45	2,45
Empty weight (kg)	2060	2130	2460	2550
Wheels	5.50-60-22.5/12PR		5.50-60-22.5/16PR	

TECHNICAL SPECIFICATIONS

Double stainless-steel discs
Working width: from 12 to 24 m.
Opening-closing hydraulic control
Selector sieve
Transmission with safety clutch
Support
Set of lights (range light, winking light, stoplight)
Service stair
Mechanical brake (parking)
Homologation for registration
Connector and liquid packing of the band

3. SAFETY INSTRUCTIONS

3.1 SAFETY SYMBOLS

You will find, in this operating manual, three types of safety and danger symbols:



To facilitate operation with the fertilizer spreader



To avoid damages on the fertilizer spreaders or in the optional equipments



This symbol warns of the risk of injury

On the machine, you will find the following danger symbols:

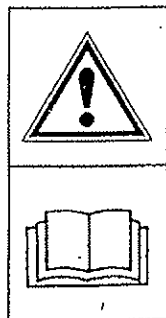

Please, read all safety and use instructions contained in this operation manual with care and also observe all warning signs attached to the fertilizer spreaders



Stay away of the tractor back part during the coupling operation.
Danger of serious lesions.

Observe the load limit

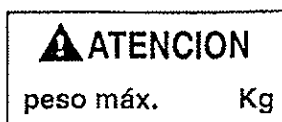

SAFETY INSTRUCTIONS

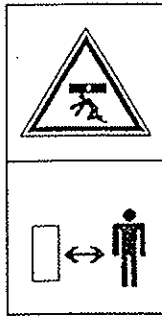

If you are working under the machine, it is very important to assure it to avoid its collapse. Danger of serious lesions.



Stay away of the fertilizer spreader. Fertilizer grains impact can cause a serious lesions.

Discs and spreader blades can cause serious lesions.

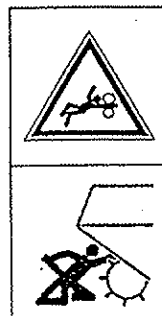

Turn direction of the power takeoff



Coupling point for the transport by crane



SAFETY INSTRUCTIONS

3.2 PROPER USE

Fertilizer Spreaders SOLA SV-6 and SV-7 has been produced for the agricultural works, specially for fertilizing with mineral products.

SOLA cannot be held liable for any consequential damage resulting from incorrect use, metering or distribution.

All relevant accident prevention regulations, as well as other generally acknowledged safety and road traffic regulations, must be observed.

SOLA fertilizer spreaders are intended for fertilizing. Any uses or modifications other than those will automatically exempt SOLA from its/his liability in respect on ensuing damages.

3.3 GENERAL SAFETY ARRANGEMENTS

- Before starting the machine, it is very important to read the operation safety and road safety.
- Road traffic regulations must be observed when towing the fertilizer spreader on roads.
- Before to bring into operation the machine, it is very important to know the parts and the elements.
- Be extremely careful when coupling and uncoupling the fertilizer spreader to tractor.
- The transmission of the power take-off must be fitted with a protective equipment and in good conditions. Avoid the turns of the protector tube with the chain. The side of the clutch will be fit in the fertilizer spreader.
- The transmission of the power take-off must be fitted when the engine is stopped.
- Before to connect the power take-off, make sure that nobody is standing in dangerous proximity to the fertilizer spreader.
- It is forbidden to stay near of the spreader disc when the machine is starting.

SAFETY INSTRUCTIONS

- The fertilizer spreader hopper must be filled when the machine is on the ground, with the engine stopped and the fertilizer trap devices closed.
- When the seed drill is raised, the tractor front axle discharges. Verify that the charge is enough to avoid lodging danger. In this situation, verify direction and braking capacity.
- Do not place strange elements inside the hopper.
- Always, connect the power take-off with the shaft.
- Do not ride on the fertilizer spreader during the transport or during the work.

4. ESSENCIAL CONCEPTS FOR FERTILIZING

4.1 CONCEPTS FOR A GOOD WORK

1- FERTILIZER GRANULOMETRY

Fertilizer with irregular sizes must be refused in order to avoid an incorrect distribution.

2- P.T.O. SPEED

The P.T.O. speed determines the speed turn discs. The working width will change if the speed is modifies. Speed must be 540 r.p.m.

3- WORKING SPEED

Changes in working speed can modify the fertilizer quantity. Speed must be steady.

4- HOPPER POSITION

Hopper must be horizontal. Lateral movements, forwards and backwards can modify the fertilizer distribution.

5- WORKING HEIGHT

Working height must be uniform to 75 cm from the ground. Verify the height on the working ground, never in the moment to coupling the machine. Height could be different.

6- DO NOT FERTILIZER IF IT IS WINDY

The wind modifies the fertilizer grains trajectory and their distribution.

7- WEAR OF THE DISCS AND BLADES

Blades are essential in the fertilizer spreader distribution. Wear of the discs and blades can influence in the fertilizer spreader on the ground. It is necessary to have then in good conditions.

8- VERIFY THE FERTILIZER FLOW

It is very important to realise a previous test in the store to know the fertilizer we will spread on the land. The dosage is very variable and it depends on the fertilizer type, density, humidity, etc.

9- DISTANCE BETWEEN ADJACENT RUNS

To conserve the distance between runs it is very important to have a good distribution. To know the same distance, follow the adjustment instructions as you can see in the manual. To have more precision, you can do a test in the land with boxes placed on the ground, verifying the fertilizer quantity collected in each box.

5. SETTING OF THE FERTILIZER SPREADER

5.1 METHOD FOR FERTILIZER SPREADER SETTING

Basic process to adjust the fertilizer spreader:

- 1- To know the type of the fertilizer, granulometry, density, etc. to compare it with another fertilizer placed in this manual.
- 2- To know the distribution dose (kg/ha) to spread.
- 3- To choose the working width.
- 4- Verify the dosage table for each fertilizer type, and choose the flow in the ruled column kg/Ha., according to the working speed. Adjust the blades and the flow control.
- 5- To realise a flow test to verify the correct distribution.
- 6- To fertilize in a little and knew land in order to verify the distribution.

5.2 PHYSICAL KNOWLEDGE OF FERTILIZER

The distribution of the fertilizer changes a lot if the fertilizer conditions are different. It will be necessary a different adjustment of the fertilizer spreader for each type of fertilizer.

The physical attributes of the fertilizer are: density and granulometry.

DENSITY

It is the weight for volume unity and it is measured in kg/dm³. Humidity can change it. We must compare the fertilizer density at the dosage tables.

GRANULOMETRY

The granulometry informs us about the sizes of the fertilizer grains. In the dosage tables we can see the granulometry of each fertilizer. Depending of the grains diameter, and group percentage are divided in 4 groups.

- Ø 4,75 grains percentage > 4,75 mm of diameter
- Ø 3,3 grains percentage > 3,3 mm and < 4,75 mm
- Ø 2 grains percentage > 2 mm and < 3,3 mm
- Ø <2 grains percentage < 2 mm

For convention, the fraction containing more than 50% determines the fertilizer classification. To qualify if a fertilizer is correct, 90% of the granulometric sizes have to be maximum in 3 contiguous groups.

The granulometry of each fertilizer, can be verified through the boxes with homologate sieves. With this information we can compare the fertilizer to spread with another placed on the dosage tables.

6. FLOW TEST

To know the fertilizer flow spreads by the fertilizer spreader, we will do a test of the quantity comes out towards both blades. We will disconnect the cylinder of the transmission wheel to turns it manually.

Open the trap in the position chosen depending of the flow and concerning dosage tables.

To turn the wheel until the fertilizer falls to the blades. To pick it up easier, we can dismount the blades fixed by bolts.

After, turn the transmission wheel 21.5 times and pick up the fertilizer. Weight it and depending of working width, we have to multiply by :

Working width of 24 m: multiply by 15

Working width of 18 m: multiply by 20

Working width of 15 m: multiply by 24

Working width of 12 m: multiply by 30

This operation help us to know the flow in kg/ha. It only depends on the working width and the trap position. It is independent of the tractor speed.

7. MAINTENANCE

- Every day, the take-off transmission must be lubricated.
- Lubricate with oil the articulations of the starting lever and joints.
- To grease all the parts in motion: wheels, band, etc.
- It is necessary to wash the fertilizer spreader with water after use it.
- If the fertilizer spreader must be stocked, use protective coverings (oil, corrosion inhibitor) to avoid damages.
- It is important to wash the conveyor band platform.

MAINTENANCE OF THE CONVEYOR BAND – CONVEYOR BAND EXTRACTION

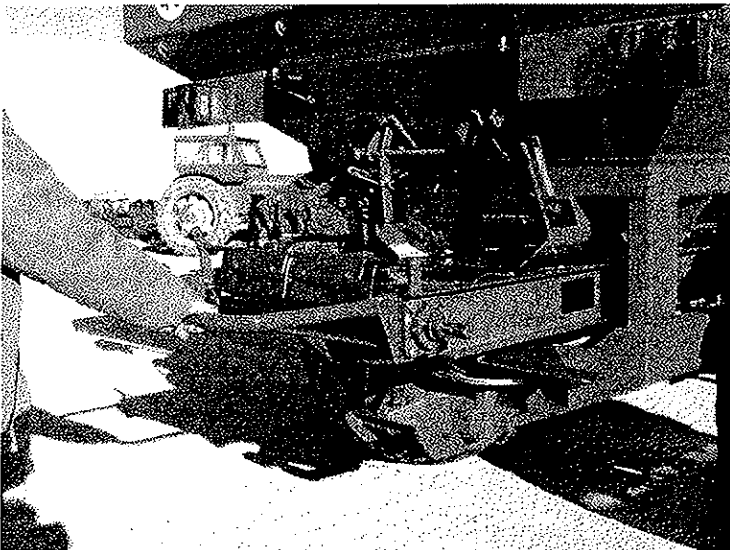

Take out the bolts fixing the band platform.

Disconnect the cylinder rod of the wheel starting the band shut-off.

Once disconnected, take out the conveyor band platform.

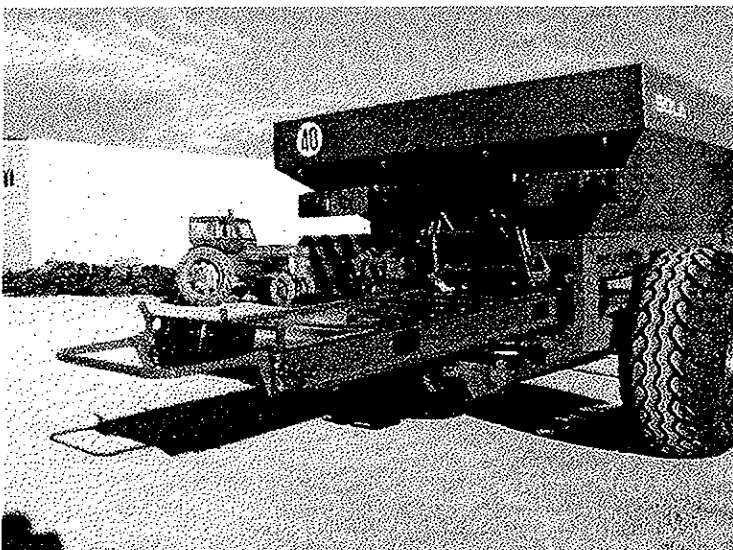

DESIGNATION OF THE DIFFERENT DISCS HOLES AND FERTILIZER SPREADER BLADES

The letters A, B, C inform us about the bolt position on the different holes of the disc.

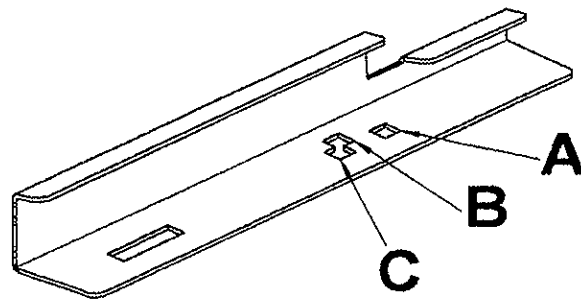

Left blade (it must be fitted on the disc of the left side in starting sense)

Numbers 1, 2, 3 inform us about the blade position on the different holes of the disc.

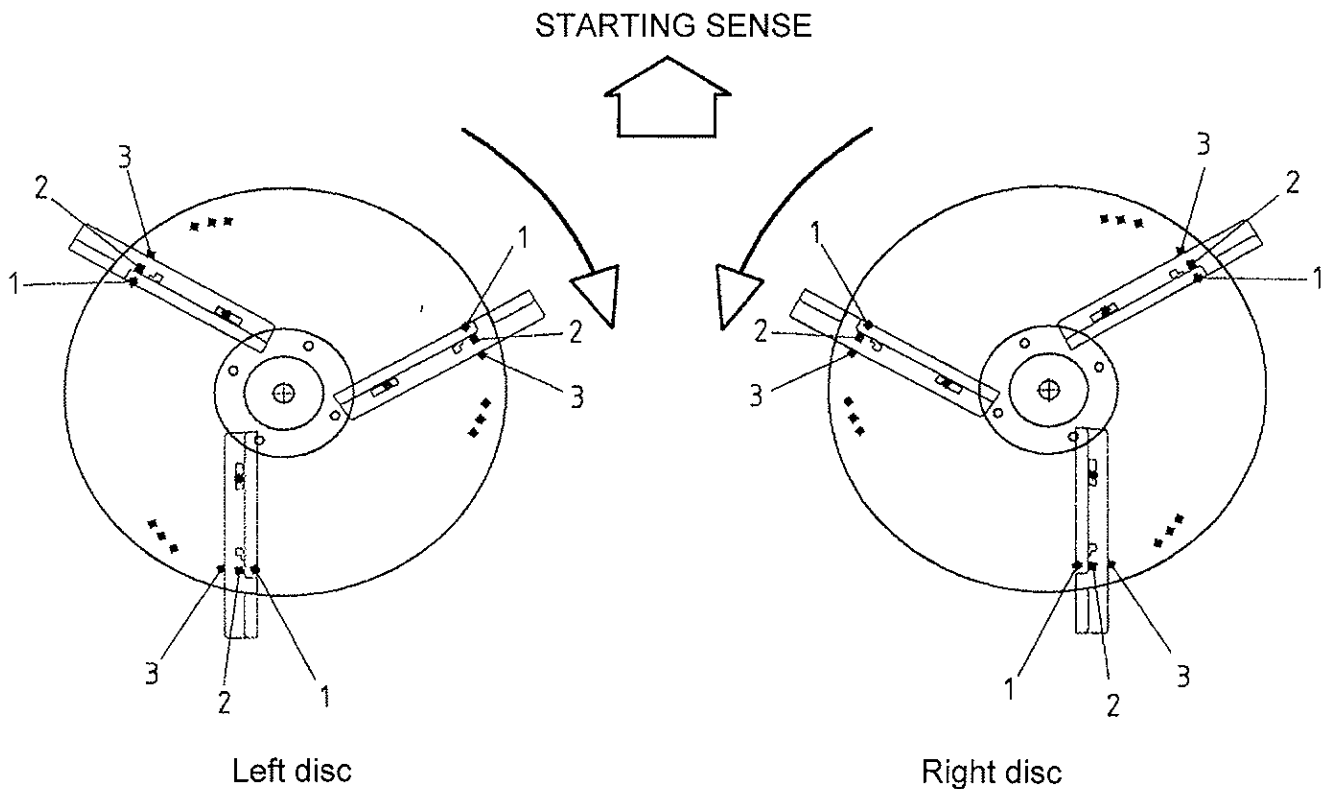

8. DOSAGE TABLES

In dosage tables you can find the dose in kg/ha depending on the working width and the working speed.

The quantities showed in the tables are for guidance only. The flow can change depending on the granulometry, density, humidity, etc.

For fertilizers do not showed in the list, we look for the most similar in granulometry and density.

SYMBOLS USED IN THE TABLES



= Position of the setting trap lever

km/h

= working speed in km/h



= Blades position

kg/min.

= Flow in kg/min

abono: **NPK 15-15-15 FERTIBERIA**

densidad: 0,95 Kg/dm³





granulometría: ø 4,75=5%

ø 3,3=65%

ø 2 =30%



ø<2 =0%



	Ancho 18 m.			Ancho 21 m.			Ancho 24 m.		
	kg/ha.	km/h.		kg/ha.	km/h.		kg/ha.	km/h.	
2	70	6 / 8 10 / 12		60	6 / 8 10 / 12		52	6 / 8 10 / 12	
3	107	6 / 8 10 / 12		92	6 / 8 10 / 12		80	6 / 8 10 / 12	
4	144	6 / 8 10 / 12	B2-B2-B2	124	6 / 8 10 / 12	B2-B2-B2	108	6 / 8 10 / 12	B2-B2-B2
5	183	6 / 8 10 / 12		157	6 / 8 10 / 12		137	6 / 8 10 / 12	
6	222	6 / 8 10 / 12	B2-B2-B2	191	6 / 8 10 / 12	B2-B2-B2	167	6 / 8 10 / 12	B2-B2-B2
7	263	6 / 8 10 / 12		226	6 / 8 10 / 12		197	6 / 8 10 / 12	
8	304	6 / 8 10 / 12	B2-B2-B2	261	6 / 8 10 / 12	B2-B2-B2	228	6 / 8 10 / 12	B2-B2-B2
9	347	6 / 8 10 / 12		298	6 / 8 10 / 12		260	6 / 8 10 / 12	
10	390	6 / 8 10 / 12	B2-B2-B2	335	6 / 8 10 / 12	B2-B2-B2	293	6 / 8 10 / 12	B2-B2-B2
11	435	6 / 8 10 / 12		373	6 / 8 10 / 12		326	6 / 8 10 / 12	
12	480	6 / 8 10 / 12	B2-B2-B2	412	6 / 8 10 / 12	B2-B2-B2	361	6 / 8 10 / 12	B2-B2-B2
13	527	6 / 8 10 / 12		452	6 / 8 10 / 12		396	6 / 8 10 / 12	
14	574	6 / 8 10 / 12		492	6 / 8 10 / 12		432	6 / 8 10 / 12	
15	623	6 / 8 10 / 12		534	6 / 8 10 / 12		468	6 / 8 10 / 12	

abono: **UREA FERTIBERIA**
 densidad: 0,75 Kg/dm³
 granulometría: \varnothing 4,75=0%
 \varnothing 3,3=0%
 \varnothing 2 =10%
 \varnothing <2 =90%



	Ancho 9 m.			Ancho 18 m.		
	kg/ha.	km/h.		kg/ha.	km/h.	
2	89	6 / 8 10 / 12		54	6 / 8 10 / 12	
3	147	6 / 8 10 / 12		83	6 / 8 10 / 12	
4	212	6 / 8 10 / 12	B2-B2-B3	113	6 / 8 10 / 12	B2-B2-B3
5	283	6 / 8 10 / 12		143	6 / 8 10 / 12	
6	359	6 / 8 10 / 12	B2-B2-B3	174	6 / 8 10 / 12	B2-B2-B3
7	439	6 / 8 10 / 12		206	6 / 8 10 / 12	
8	521	6 / 8 10 / 12	B2-B2-B3	238	6 / 8 10 / 12	B2-B2-B3
9	604	6 / 8 10 / 12		270	6 / 8 10 / 12	
10	687	6 / 8 10 / 12	B2-B2-B3	304	6 / 8 10 / 12	B2-B2-B3
11	769	6 / 8 10 / 12		338	6 / 8 10 / 12	
12	849	6 / 8 10 / 12		372	6 / 8 10 / 12	
13	925	6 / 8 10 / 12		408	6 / 8 10 / 12	
14	996	6 / 8 10 / 12	B2-B2-B3	444	6 / 8 10 / 12	B2-B2-B3
15	1061	6 / 8 10 / 12		480	6 / 8 10 / 12	

abono: **NITRATO AMONICO CALCICO 27% FERTIBERIA**

densidad: ~1 Kg/dm³





granulometría: ø 4,75=0%

ø 3,3=80%

ø 2 =20%

ø<2 =0%



	Ancho 18 m.			Ancho 21 m.			Ancho 24 m.		
	kg/ha.	km/h.		kg/ha.	km/h.		kg/ha.	km/h.	
2	72	6 / 8 10 / 12		61	6 / 8 10 / 12		55	6 / 8 10 / 12	
3	114	6 / 8 10 / 12		98	6 / 8 10 / 12		86	6 / 8 10 / 12	
4	157	6 / 8 10 / 12	B2-B2-B2	135	6 / 8 10 / 12	B2-B2-B2	118	6 / 8 10 / 12	B2-B2-B2
5	202	6 / 8 10 / 12		171	6 / 8 10 / 12		152	6 / 8 10 / 12	
6	240	6 / 8 10 / 12	B1-B1-B2	206	6 / 8 10 / 12	B1-B2-B2	180	6 / 8 10 / 12	B1-B2-B2
7	278	6 / 8 10 / 12		239	6 / 8 10 / 12		209	6 / 8 10 / 12	
8	316	6 / 8 10 / 12	B1-B2-B2	271	6 / 8 10 / 12	B2-B2-B2	237	6 / 8 10 / 12	B2-B2-B2
9	354	6 / 8 10 / 12		304	6 / 8 10 / 12		266	6 / 8 10 / 12	
10	396	6 / 8 10 / 12	B2-B2-B2	340	6 / 8 10 / 12	B2-B2-B2	297	6 / 8 10 / 12	B2-B2-B2
11	444	6 / 8 10 / 12		382	6 / 8 10 / 12		333	6 / 8 10 / 12	
12	503	6 / 8 10 / 12	B2-B2-B2	432	6 / 8 10 / 12	B2-B2-B2	377	6 / 8 10 / 12	B2-B2-B2
13	577	6 / 8 10 / 12		497	6 / 8 10 / 12		432	6 / 8 10 / 12	
14	672	6 / 8 10 / 12		580	6 / 8 10 / 12		503	6 / 8 10 / 12	
15	795	6 / 8 10 / 12		688	6 / 8 10 / 12		595	6 / 8 10 / 12	

TRANSMISSION



FIG	CODE
1	VI-4911000
2	VI-4911021
3	PL-040203
4	VI-045832
5	985 12 I
6	933 14X35 BI
7	VI-4600471
8	9021 14 BI
9	VI-4680175
10	VI-045833
11	VI-045834
12	VI-4680170
13	VI-045835

TRANSMISSION PROTECTIVE PLATES

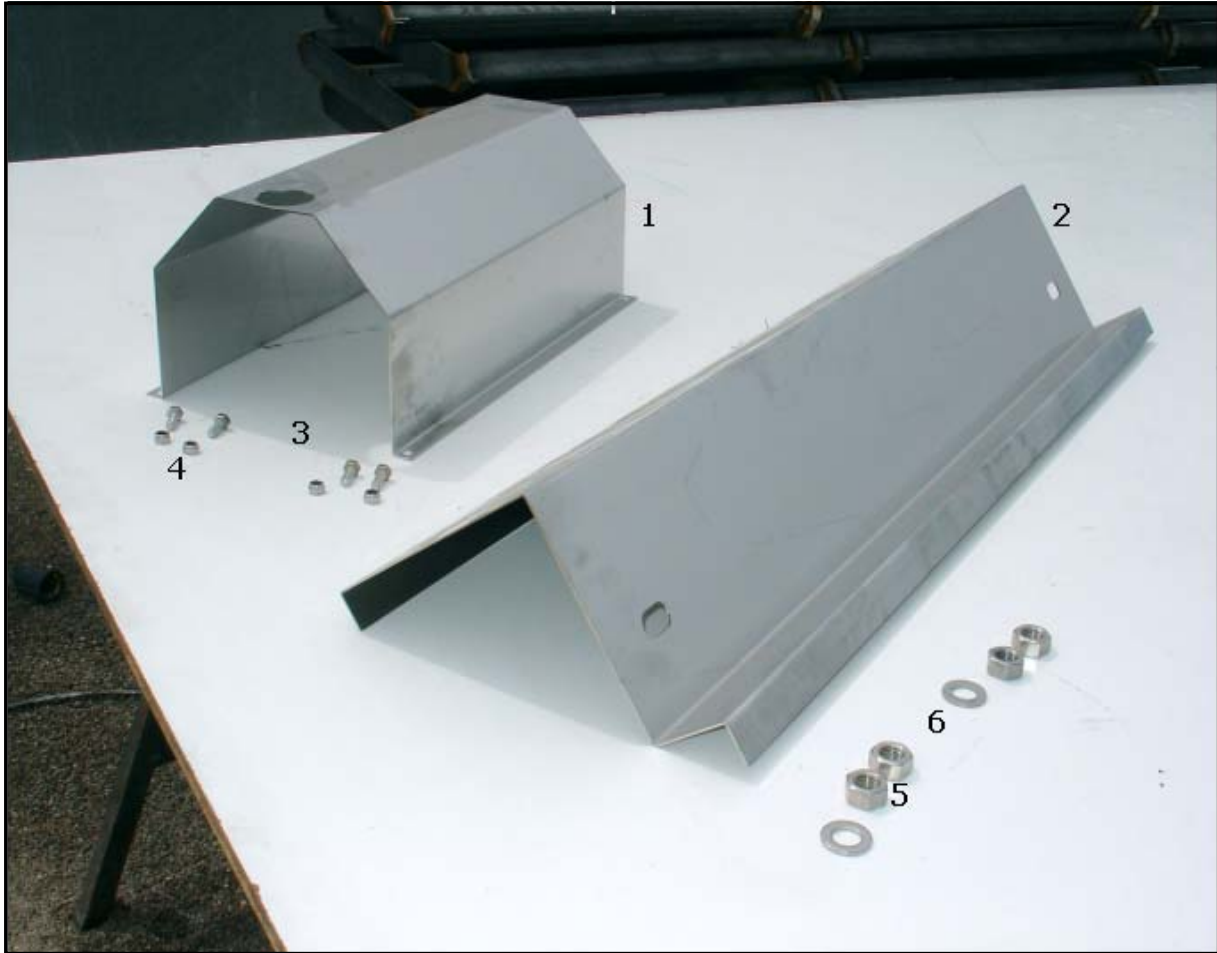

FIG	CODE
1	VI-045846
2	VI-045847
2	VI-045848
3	933 8X20 I
4	985 8 I
5	934 16 I
6	125 16 I

TRANSMISSION AXLE

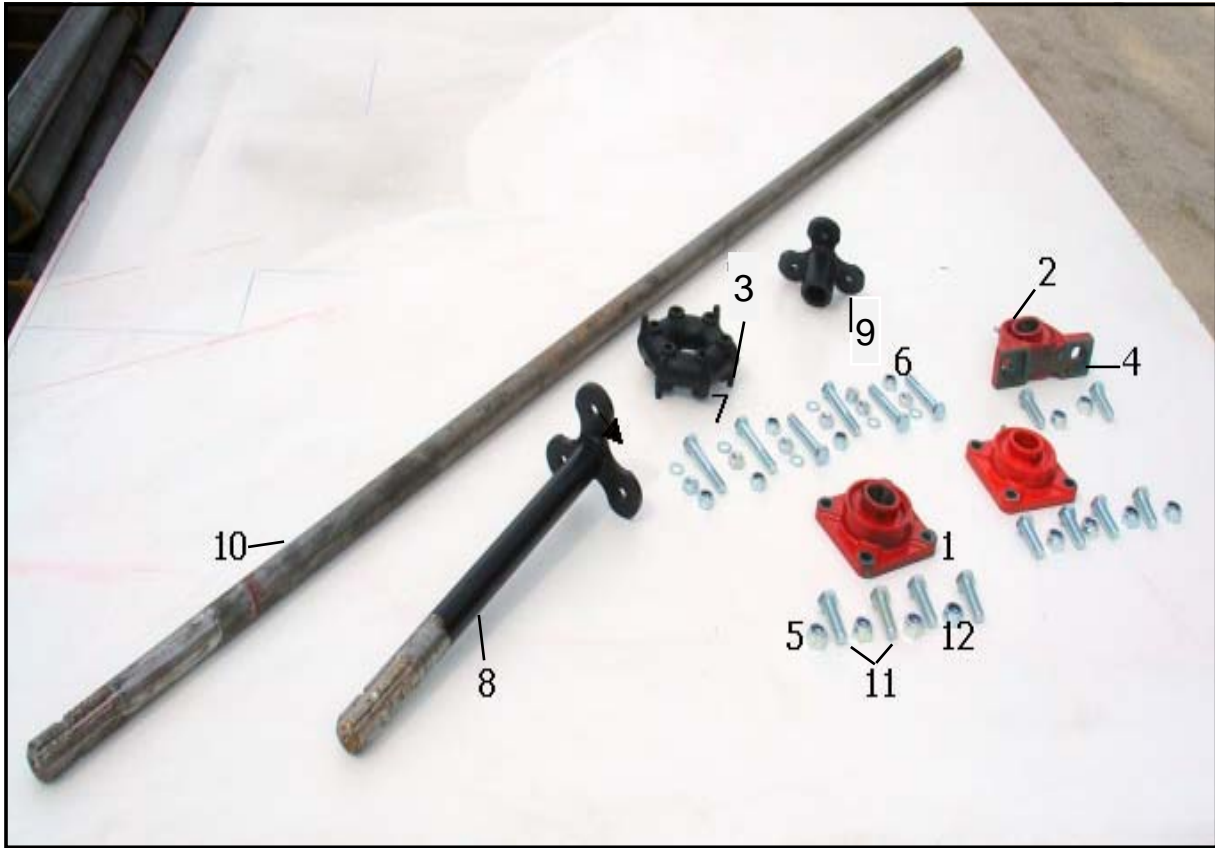

FIG	CODE
1	VI-045825
2	VI-045857
3	FE-608018
4	931 12X80 BI
5	934 12 BI
6	VI-4600461
7	VI-4600343
8	VI-045858
9	VI-045826
10	VI-5614300
10	VI-5614320
11	933 14X45 BI
12	VI-4600471

TAPE TRANSMISSION REDUCTOR

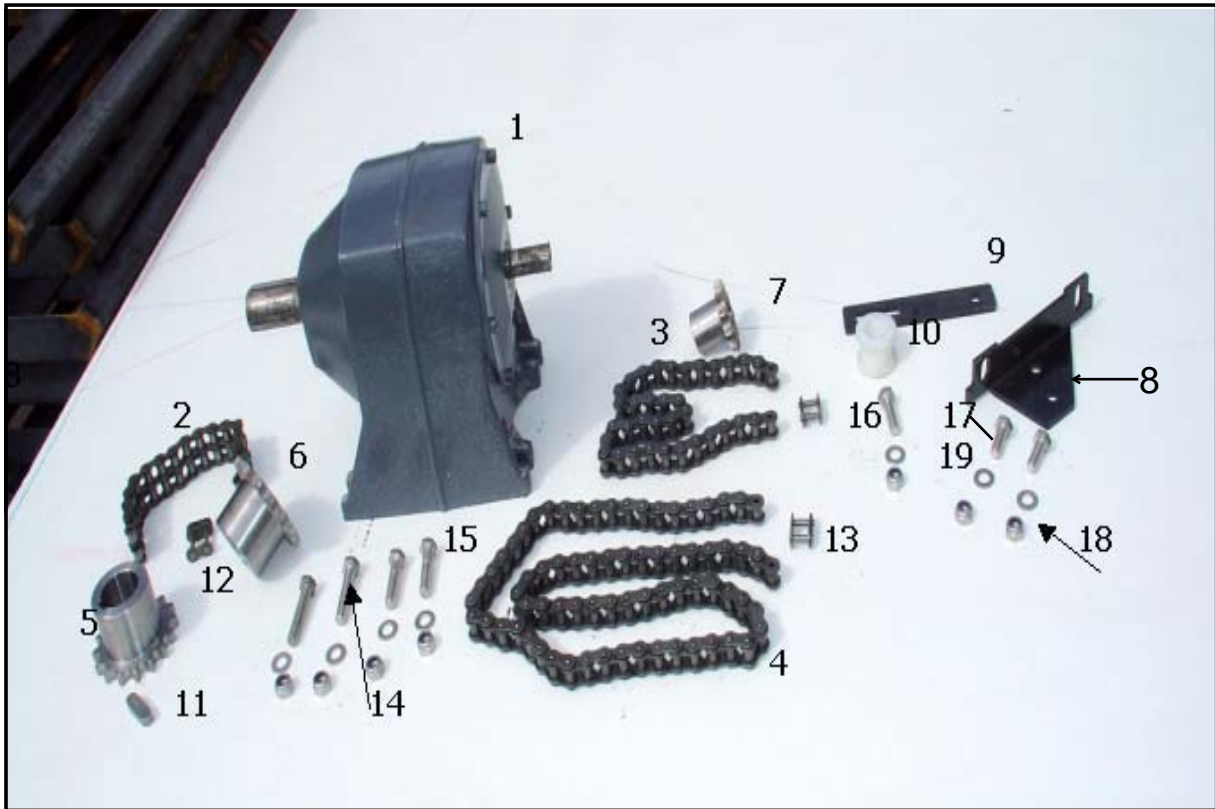

FIG	CODE
1	VI-4950185
2	VI-045859
3	VI-045860
4	VI-045861
5	VI-5100190
6	VI-5100200
7	VI-5100205
8	VI-045862
9	VI-045863
10	VI-045864
11	VI-4680075
12	VI-5120008
13	VI-5120009
14	933 12X60 I
15	933 12X50 I
16	933 12X40 I
17	933 12X30 I
18	985 12 I
19	125 12 I

REDUCTOR CHAINGUARD

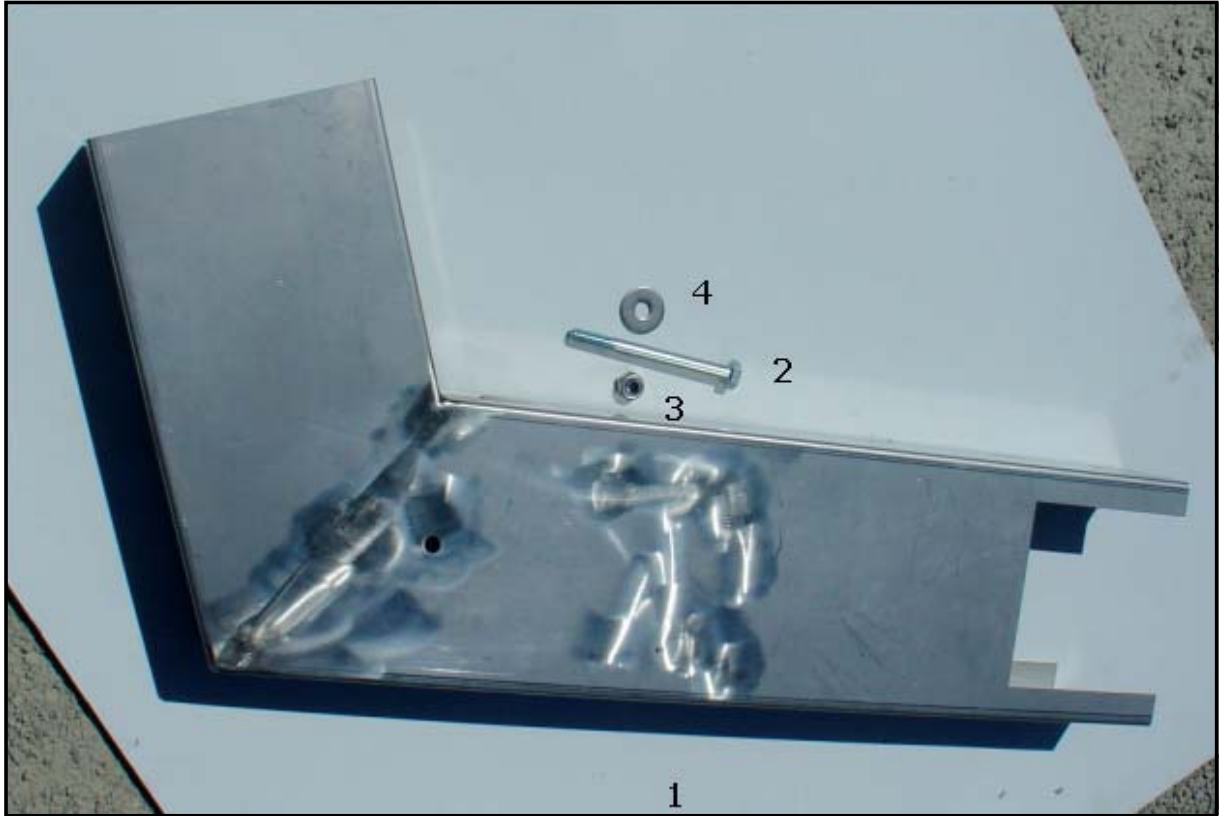

FIG	CODE
1	VI-045836
2	931 10X100 BI
3	985 10 I
4	9021 10 I

BAND BACK TRANSMISSION AXLE

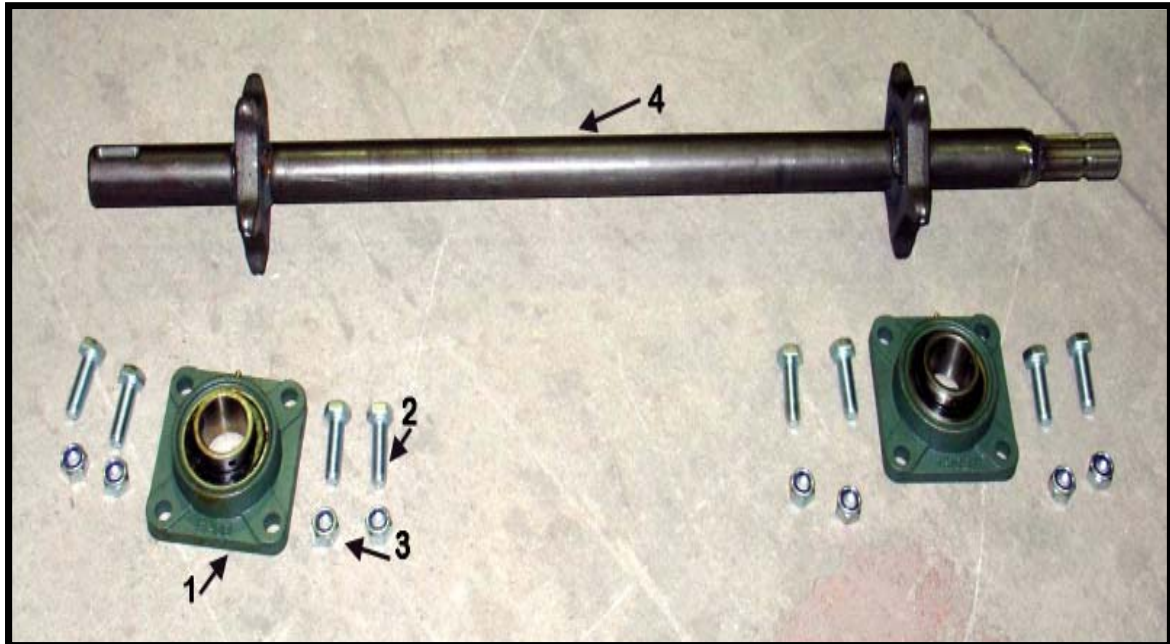

FIG	CODE
1	FE-600107
2	933 16X45 I
3	985 16 I
4	CO-045808

BAND FRONT TRANSMISSION AXLE

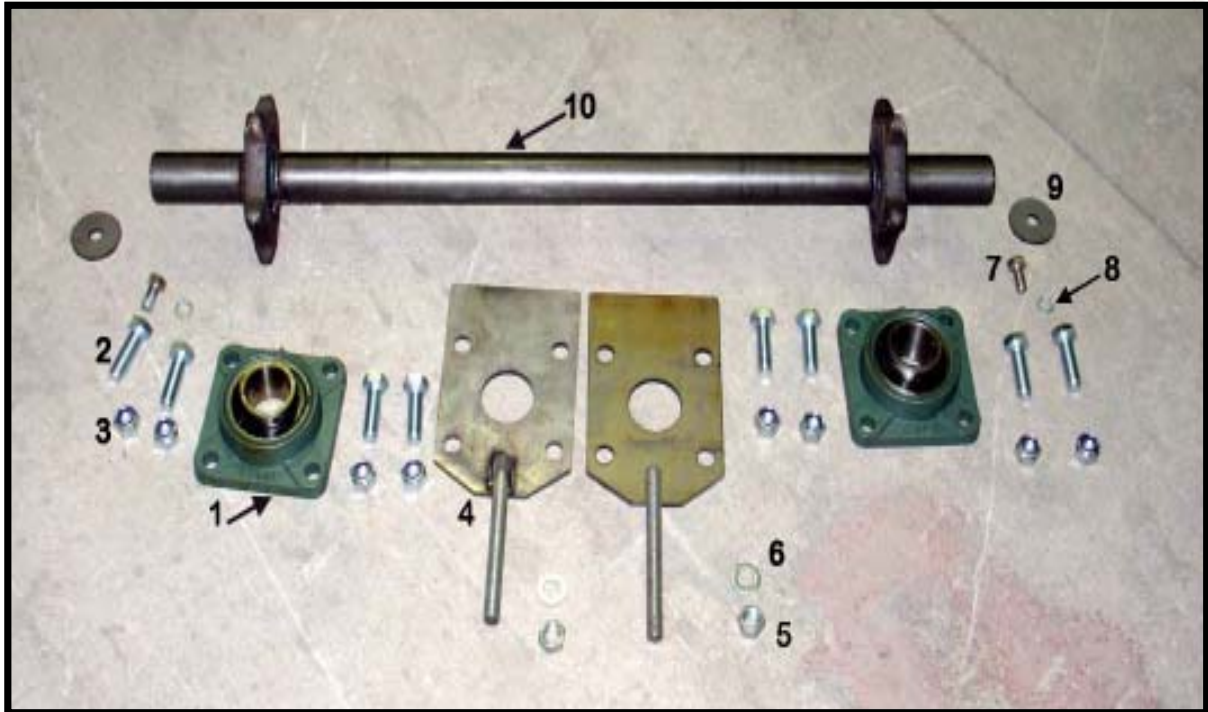

FIG	CODE
1	FE-600107
2	933 16X45 I
3	985 16 I
4	FE-613007
5	934 16 I
6	125 16 I
7	933 12X25 I
8	127 12
9	FE-614034
10	CO-045809



FIG	CODE
1	HI-708034
2	933 10X30 I
3	985 10 I

DISTRIBUTION

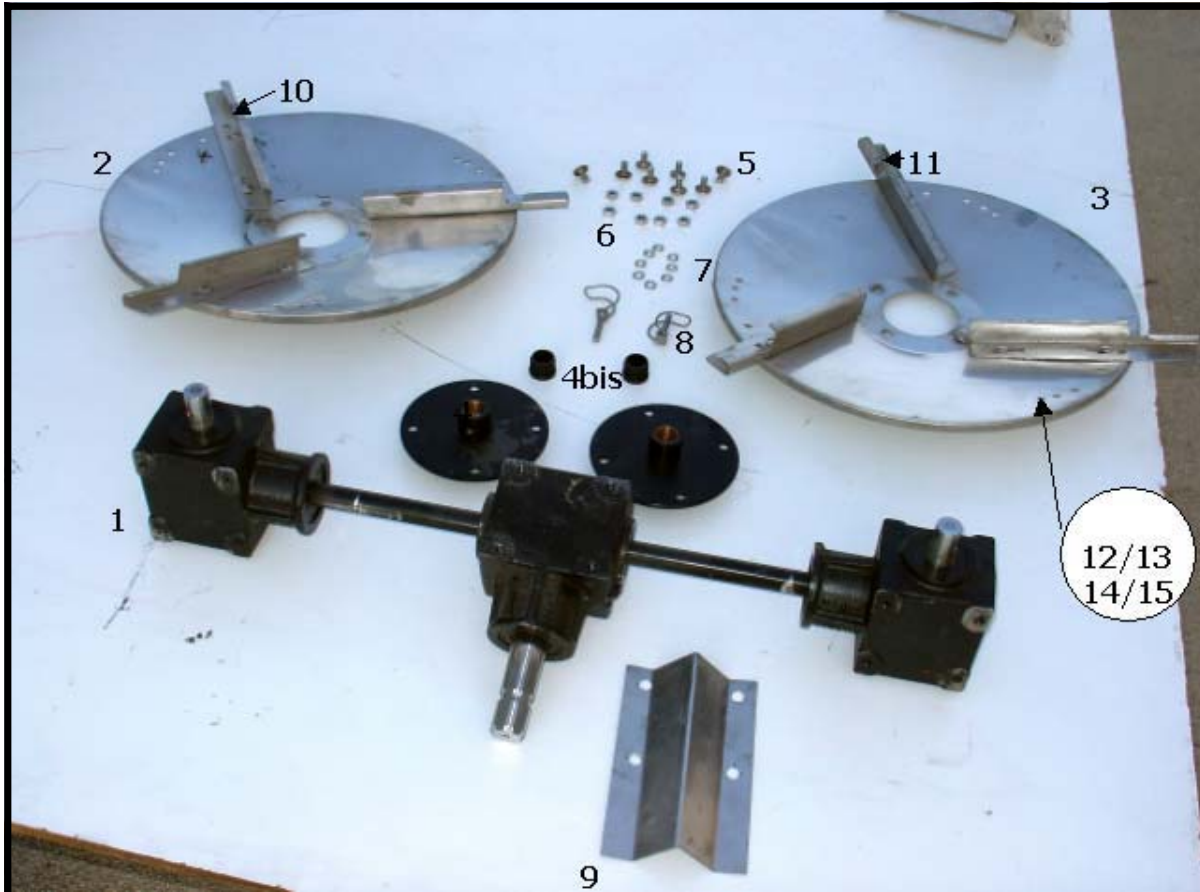

FIG.	CODE
1	CO-045800
2	MO-2107/D
3	MO-2107/I
2-3	EE-045138
4+4bis	MO-045113
5	603 10x20I
6	934 10 I
7	127 10 I
8	MO-045111
9	VI-045844
10	EE-045162/I
11	EE-045162/D
12	603 8x20I
13	315 8 I
14	125 8 I
15	127 8 I

FERTILIZER OPENING PEEPHOLE

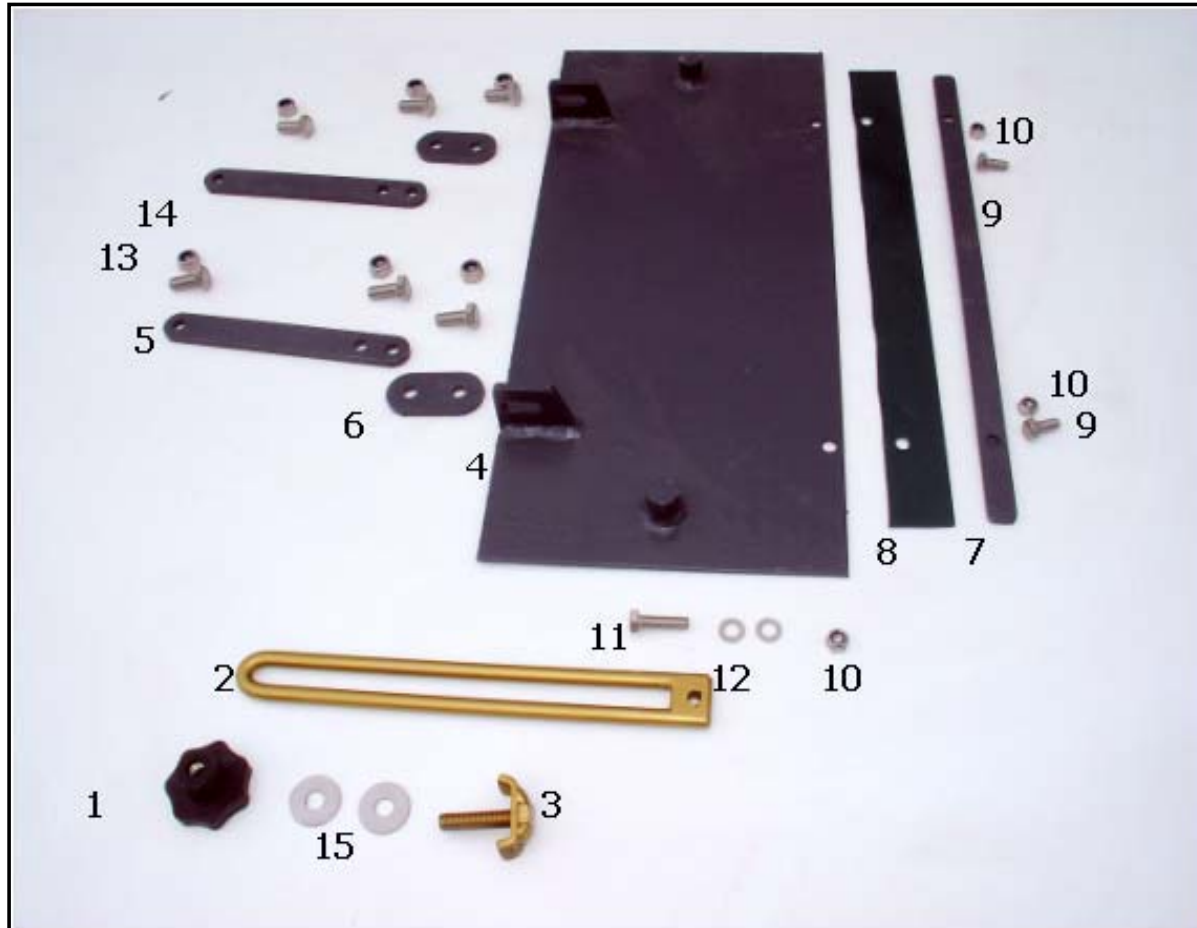

FIG	CODE
1	VI-6500030
2	VI-045837
3	VI-045838
4	VI-045839
5	VI-045840
6	VI-045841
7	VI-045842
8	VI-045843
9	933 8X20 I
10	985 8 I
11	933 8X25 I
12	125 8 I
13	933 10X25 I
14	985 10 I
15	125 10 I

FRONT PROTECTIVE

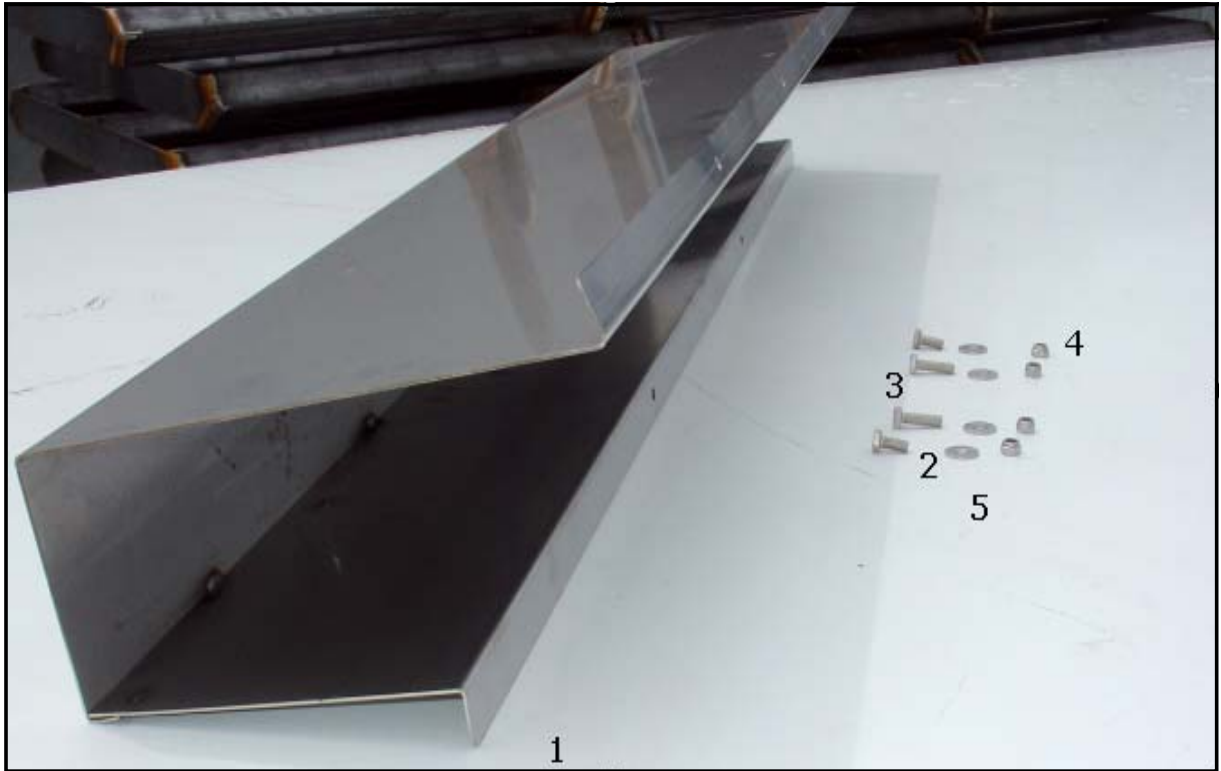

FIG	CODE
1	VI-045851
2	I933 8X20 I
3	933 8X30 I
4	985 8 I
5	9021 8 I

FERTILIZER FALLING PIPE

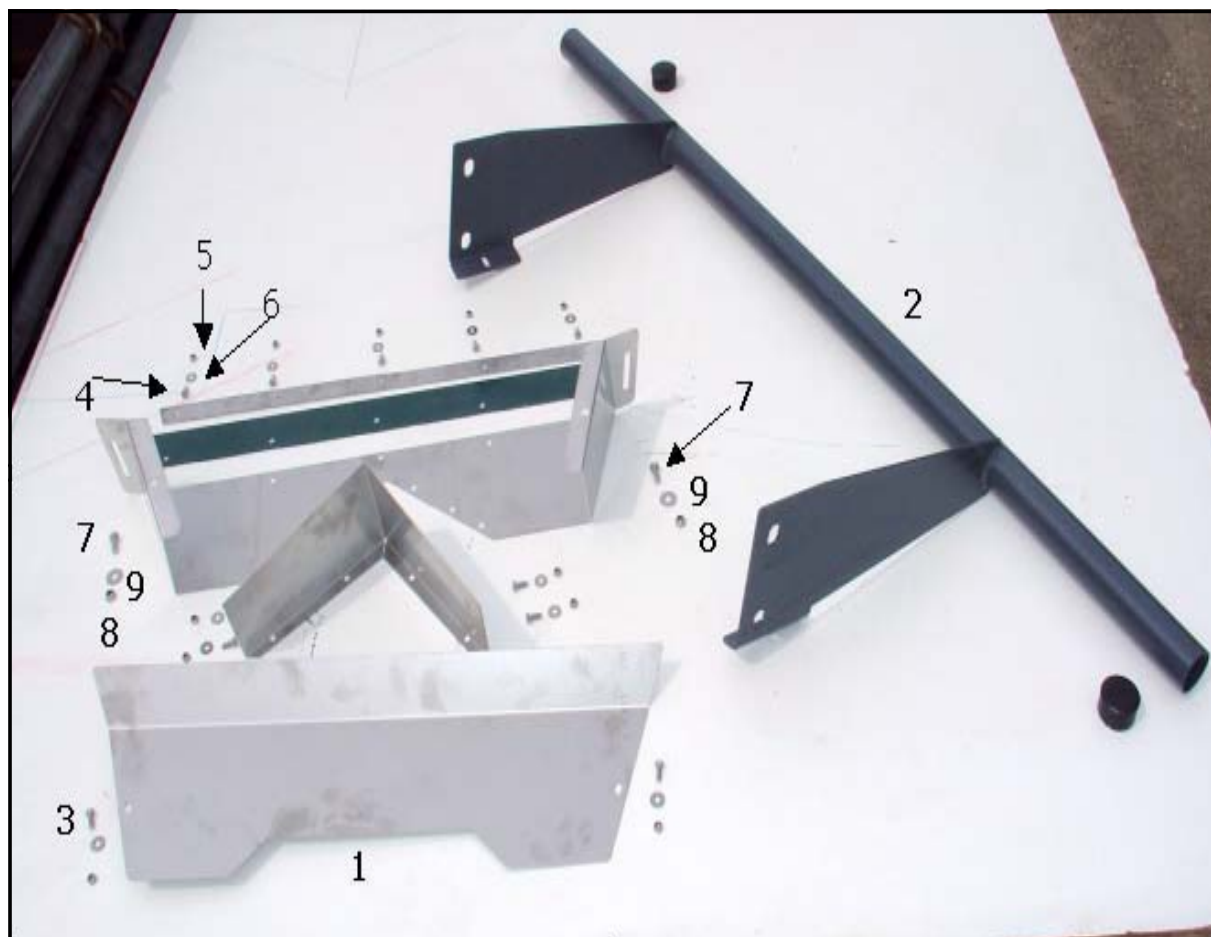

FIG	CODE
1	VI-045849
2	VI-045850
3	VI-4689050
4	933 6X16 I
5	985 6 I
6	125 6 I
7	933 8X20 I
8	985 8 I
9	125 8 I

DISTRIBUTION



FIG	CODE
1	VI-045845
2	933 8X20 I
3	985 8I
4	9021 8 I

CONVEYOR BELT

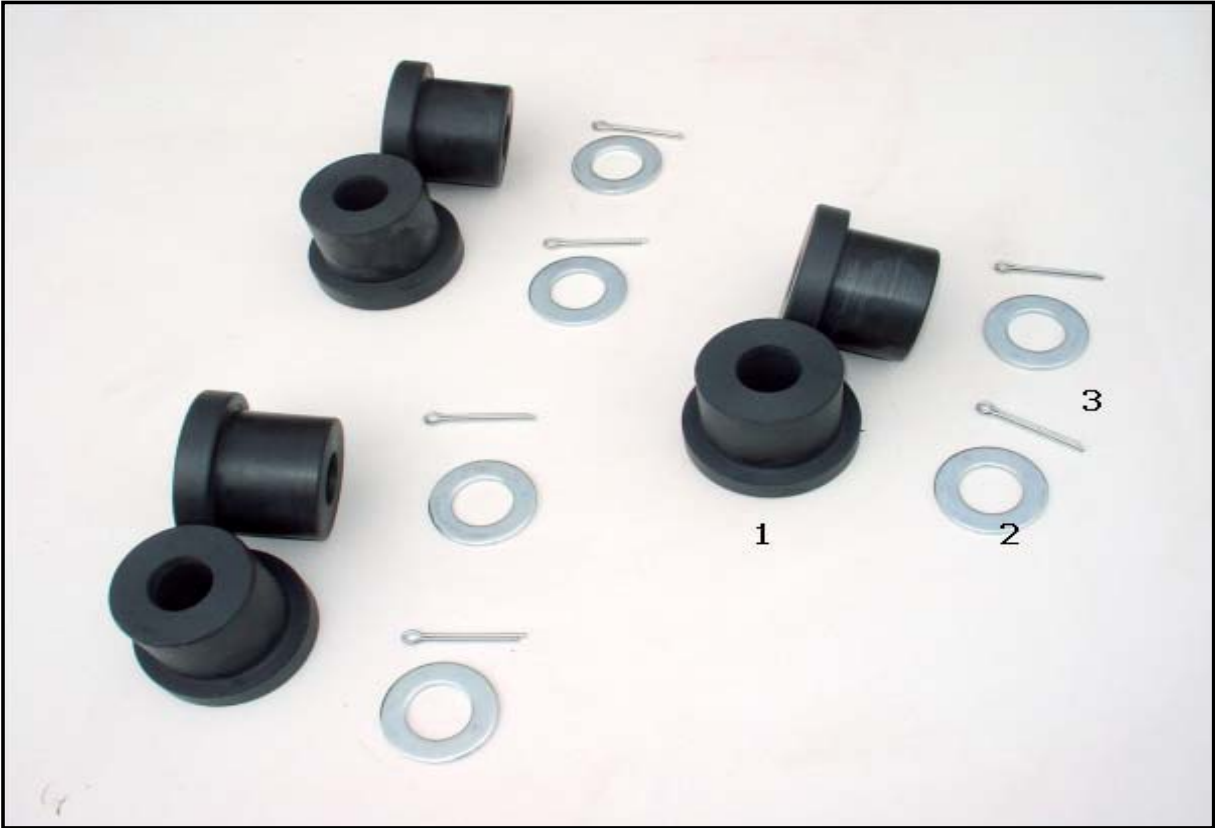

FIG	CODE
1	VI-045852
2	125 30 BI
3	FE-610017

LATERAL BAND

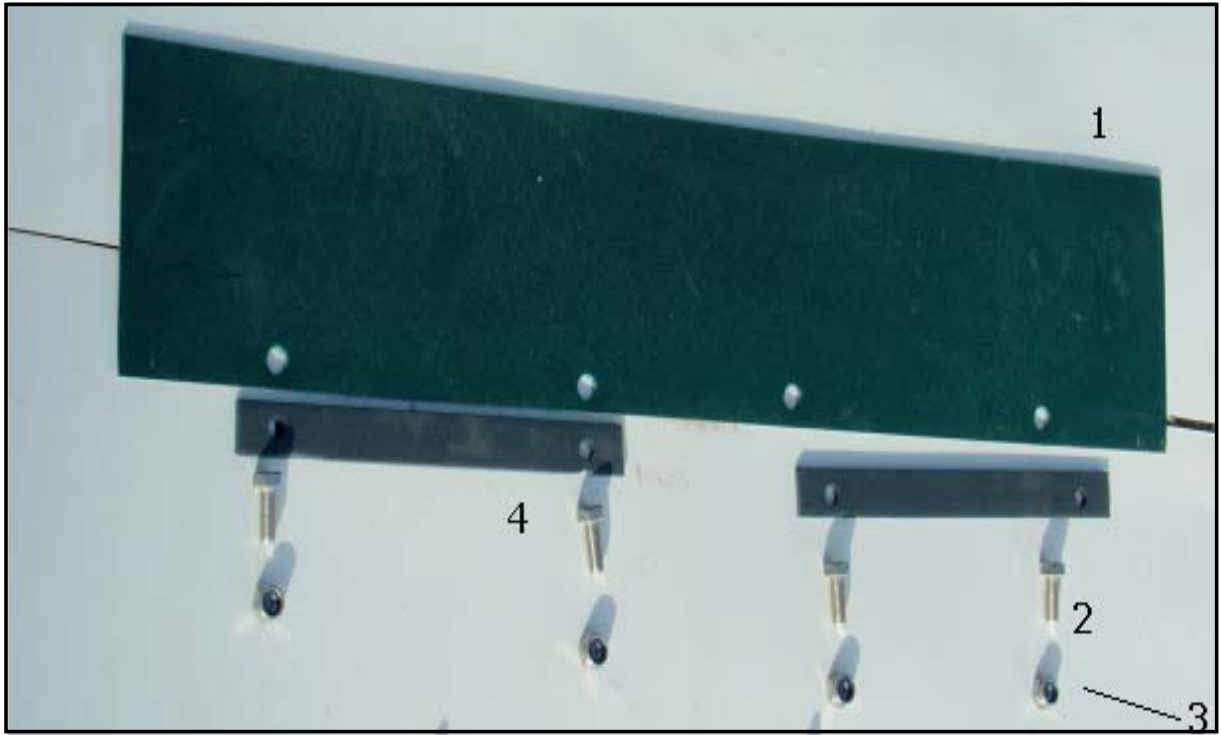

FIG	CODE
1	VI-045853
2	933 8X20 I
3	985 8 I
4	VI-045854

CONVEYOR BELT



FIG	CODE
1	VI-045865
2	VI-045866
3	VI-045867
4	VI-045868
5	VI-045869
5	VI-045870
6	603 8X20 I
7	603 8X25 I
8	933 8X20 I
9	985 8 I
10	EE-045800
11	VI-045871

HYDRAULIC PIPER

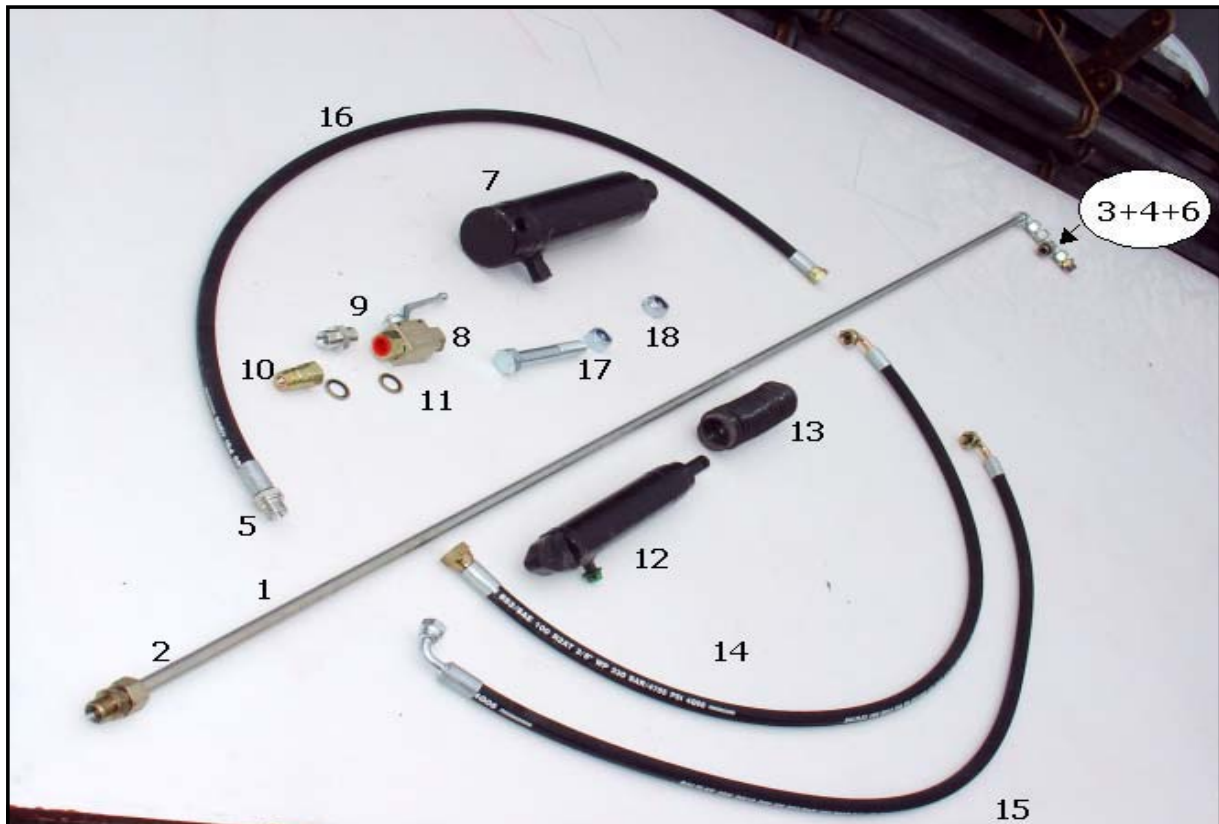

FIG	CODE
1	VI-045827
2	VI-5200342
3	VI-5200352
4	VI-5200330
5	VI-5200820
6	VI-045828
7	VI-9700100
8	VI-4907030
9	HI-704004
10	VI-4908230
11	HI-705002
12	CO-045101
13	PL-045101
14	VI-045829
15	VI-045830
16	VI-045831
17	931 20X100 BI
18	VI-4600501

BRAKE



FIG	CODE
1	VI-045827
2	VI-5200342
3	VI-5200330
4	VI-5200820
5	VI-4912010
6	VI-4912012
7	VI-4908350
8	HI-705002
9	VI-045831
10	VI-045855
11	VI-045856
12	931 16X100 BI
13	985 16
14	933 14X45 BI
15	VI-4600471
16	933 12X45 BI
17	985 12

SIGNAL EQUIPEMENT

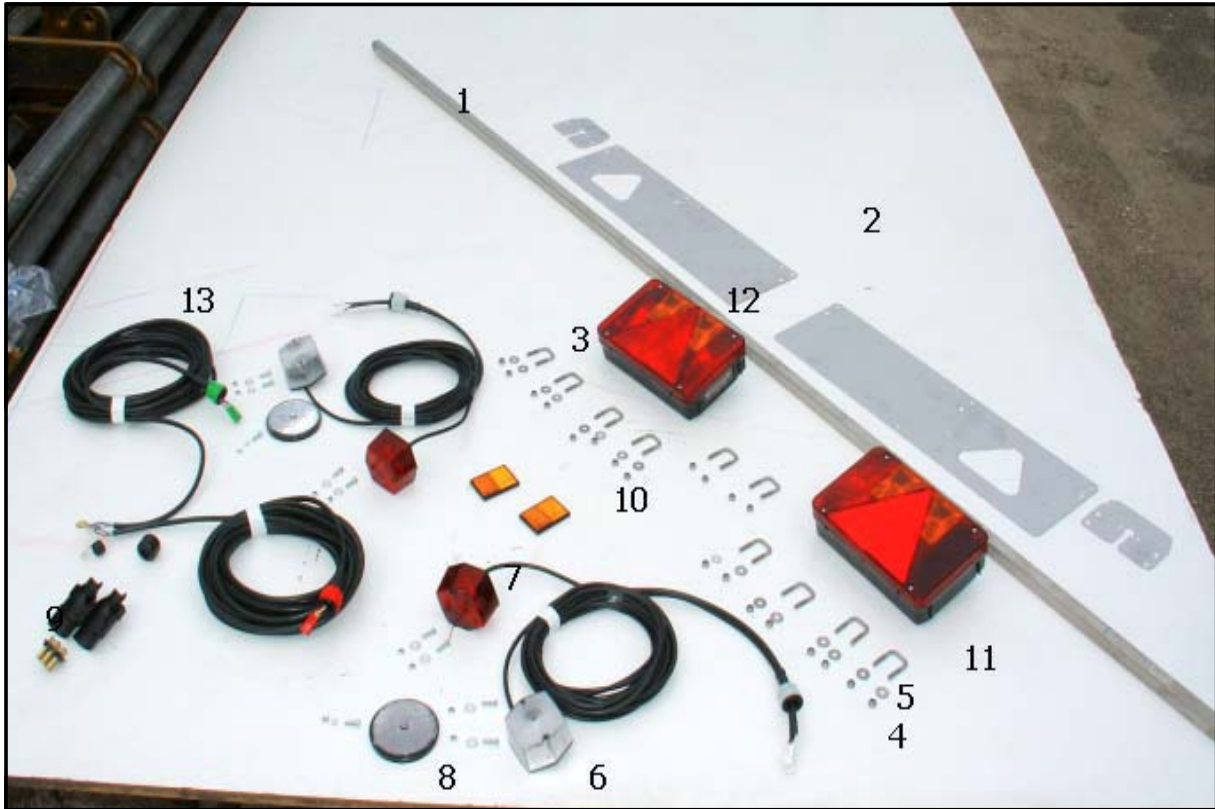

FIG	CODE
1	VI-075804
2	VI-075805
3	FE-614031
4	934 6 I
5	9021 6 I
6	VI-8000060
6	VI-8000061
7	VI-8000063
7	VI-8000064
8	VI-8000176
9	VI-8000500
10	VI-8000175
11	VI-8000120
11	VI-8000131
12	VI-8000121
12	VI-8000138
13	VI-8003500



SOLA

Carretera d'Igualada, s/n
Teléfono 938 68 00 60
Fax 938 68 00 55
www.solagrupo.com
Apartado de correos 11
08280 CALAF (Barcelona)